

# ASSEMBLY INSTRUCTIONS COASTER FINE FURNITURE



*Fine Furniture for every stage of life*

**107562**  
**DINING CHAIR**

ITEM: 107562

## ASSEMBLY INSTRUCTIONS



### ASSEMBLY TIPS:

1. Remove hardware from box and sort by size.
2. Please check to see that all hardware and parts are present prior to start of assembly.
3. Please follow attached instructions in the same sequence as numbered to assure fast & easy assembly.



### WARNING !

1. Don't attempt to repair or modify parts that are broken or defective. Please contact the store immediately.
2. This product is for home use only and not intended for commercial establishment s.



ASSEMBLY TIME

5 MINUTES

## PARTS IDENTIFICATION

A. FRONT LEFT LEG



1PC

B. FRONT RIGHT LEG



1PC

C. BACK RIGHT LEG



1PC

D. BACK LEFT LEG



1PC

E. SEAT AND BACK



1PC

## HARDWARE PACKAGE

1. ALLEN WRENCH  
(Ø1/4"\*57mm-GOLD)



1PC

2. ALLEN BOLT  
(Ø1/4"\*15mm-GOLD)



12PCS

3. FLAT WASHER  
(Ø16mm-GOLD)



12PCS

NOTE:QUANTITIES SHOWN ARE FOR ONE CHAIR

ITEM: 107562

ASSEMBLY INSTRUCTIONS



STEP 1

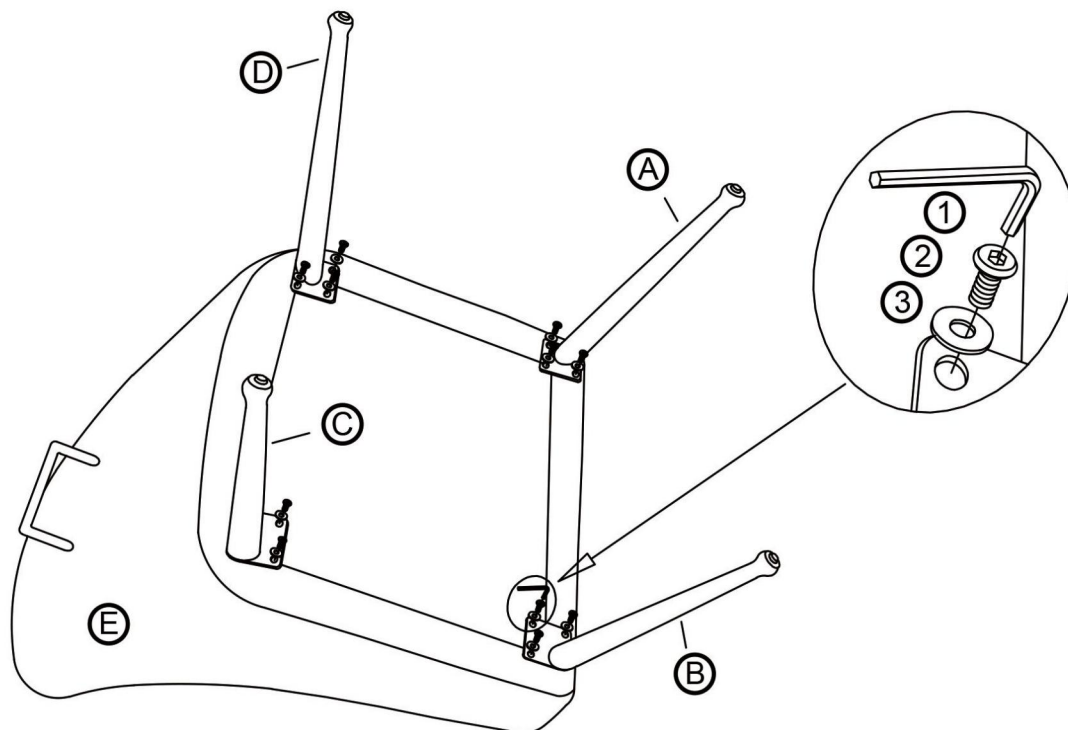

STEP 2  
COMPLETE

