

# ASSEMBLY INSTRUCTIONS COASTER FINE FURNITURE



Fine Furniture for every stage of life

120389  
BARSTOOL

REIVSION:06/16/2020  
REIVSION:08/04/2022  
REIVSION:08/22/2023

COASTERFURNITURE.COM

**ITEM :120389**  
**ASSEMBLY INSTRUCTIONS**



**ASSEMBLY TIPS:**

1. Remove hardware from box and sort by size.
2. Please check to see that all hardware and parts are present prior to start of assembly.
3. Please follow attached instructions in the same sequence as numbered to assure fast & easy assembly.







**Warning!**

1. Don't attempt to repair or modify parts that are broken or defective. Please contact the store immediately.
2. This product is for home use only and not intended for commercial establishments.



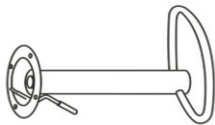

**ASSEMBLY TIME 5 MINUTES**

**PARTS IDENTIFICATION**

	<b>PART NAME</b>	<b>FIGURE</b>	<b>QTY</b>
<b>A</b>	<b>SEAT</b>		<b>1PC</b>
<b>B</b>	<b>FOOT REST</b>		<b>1PC</b>
<b>C</b>	<b>GAS CYLINDER</b>		<b>1PC</b>
<b>D</b>	<b>BASE</b>		<b>1PC</b>
<b>E</b>	<b>COVER RING</b>		<b>1PC</b>

**HARDWARE IDENTIFICATION**

	<b>HARDWARE NAME</b>	<b>FIGURE</b>	<b>QTY</b>
<b>1</b>	<b>BOLTS M6x16MM</b>		<b>4PCS</b>
<b>2</b>	<b>ALLEN WRENCH M6</b>		<b>1PC</b>

ITEM :120389  
ASSEMBLY INSTRUCTIONS



STEP 1

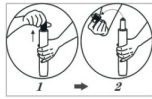

✗ Please pull out the sheath before using

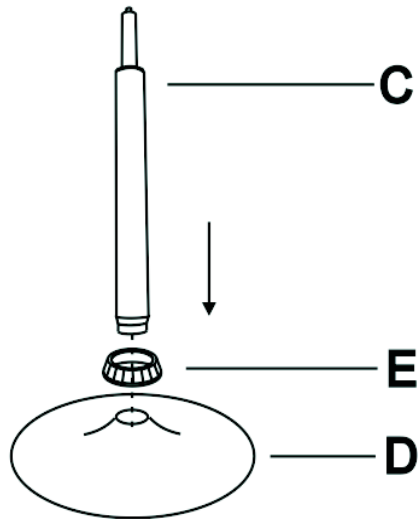

STEP 2

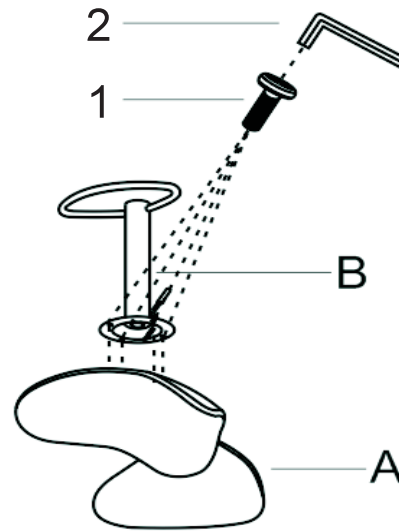

STEP 3

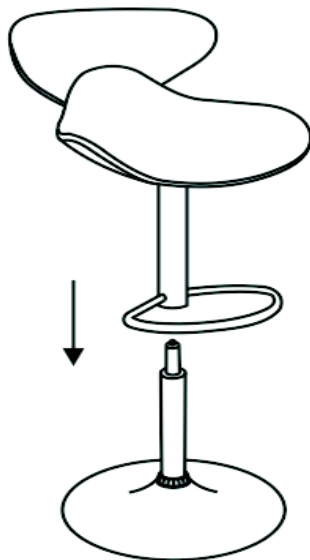

STEP 4



ITEM :120389  
ASSEMBLY INSTRUCTIONS

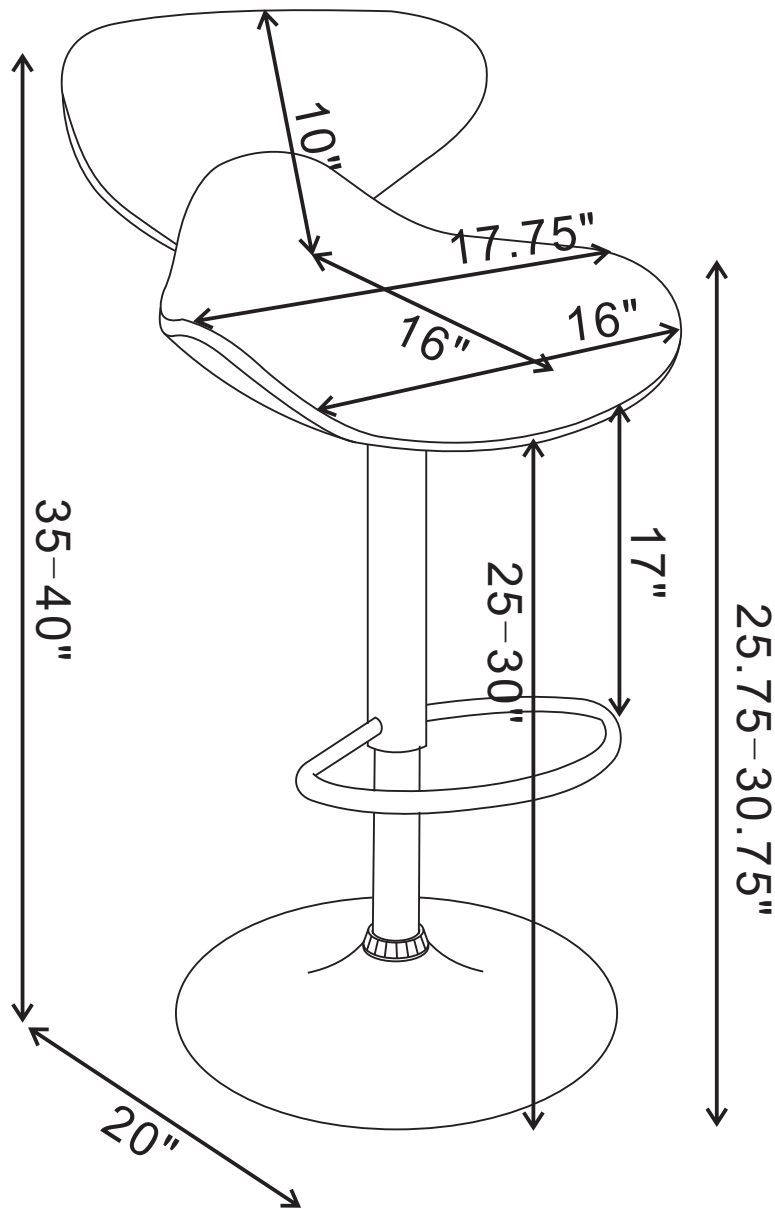

Note:Dimension tolerance±5%

COASTERFURNITURE.COM