

ASSEMBLY INSTRUCTIONS
COASTER FINE FURNITURE



Fine Furniture for every stage of life

182799
HOME BAR

ITEM:182799



ASSEMBLY INSTRUCTIONS

ASSEMBLY TIPS:

1. Remove hardware from box and sort by size.
2. Please check to see that all hardware and parts are present prior to start of assembly.
3. Please follow attached instructions in the same sequence as numbered to assure fast & easy assembly.



WARNING!

1. Don't attempt to repair or modify parts that are broken or defective. Please contact the store immediately.
2. This product is for home use only and not intended for commercial establishments.

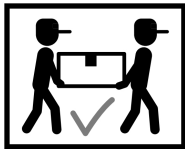

ASSEMBLY TIME 95 MINUTES

PARTS IDENTIFICATION

AN

TOP PANEL

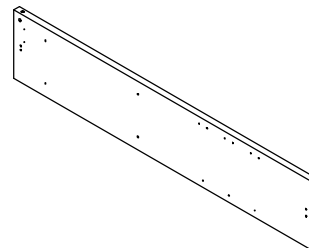

1PC

B

BOTTOM PANEL

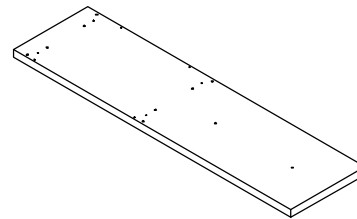

1PC

C

STORAGE TOP PANEL

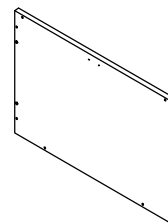

1PC

D

STORAGE SIDE PANEL

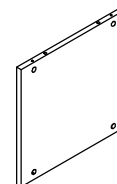

2PCS

E

STORAGE BACK PANEL

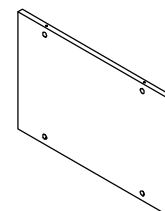

1PC

ITEM:182799

ASSEMBLY INSTRUCTIONS

PARTS IDENTIFICATION



F

LEFT DOOR

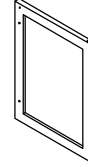

1PC

G

RIGHT DOOR



1PC

H

SIDE FRAME

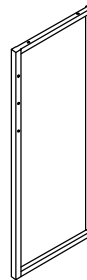

2PCS

I

BOTTLE RACK

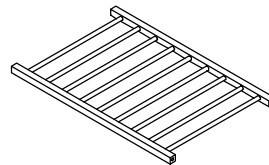

3PCS

J

SUPPORT LEG

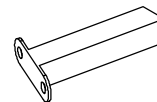

1PC

K

GLASS HOLDER

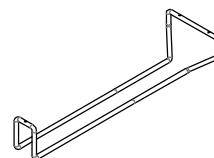

3PCS

ITEM:182799

ASSEMBLY INSTRUCTIONS

PARTS IDENTIFICATION



L TOP CURVED FRAME

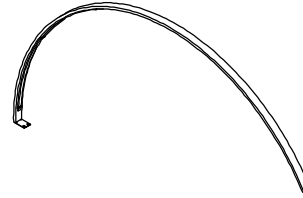

1PC

M BOTTOM CURVED FRAME

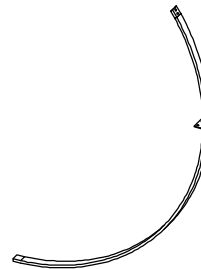

1PC

N HANDLE

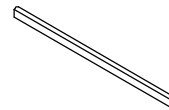

2PCS

ON CONTROL BOX

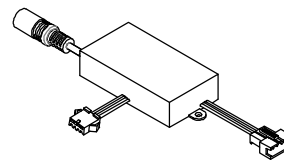

1PC

P POWER ADAPTER

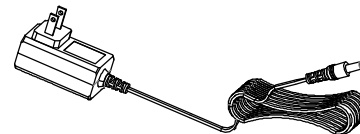

1PC

Q POWER CORD CLAMP

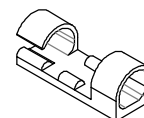

2PCS

ITEM:182799

ASSEMBLY INSTRUCTIONS



RN



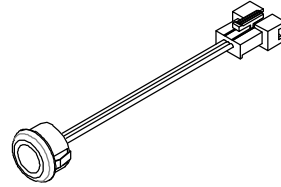















LIGHT TOUCH ON SENSOR



1PC

Z

HARDWARE IDENTIFICATION

1	CAM-BOLT (6 x 35mm SR)		12PCS	11	DOOR PIN		4PCS
2	CAM-LOCK (ϕ 15mm SR)		12PCS	12	METAL PLATE		2PCS
3	WOOD DOWEL (8 x 30mm)		12PCS	13	FLOOR PROTECTOR		1PC
4	SHORT BOLT (1/4" x 12mm)		8PCS	14	MAGNET		1PC
5	MEDIUM BOLT (1/4" x 32mm)		4PCS	15	ROUND SCREW (3.5 x 12mm)		14PCS
6	LONG BOLT (1/4" x 47mm)		18PCS	16	WASHER		1PC
7	CAP (20 x 40 mm SR)		1PC	17	GLUE		1PC
8	LEVELER (1/4" x 15mm BLK)		4PCS	18	ALLEN WRENCH (4mm)		1PC
9	COVER		14PCS				
10	HANDLE BOLT		4PCS				

ITEM:182799



ASSEMBLY INSTRUCTIONS

STEP 1 Do not tighten until each step is completed or instructed.

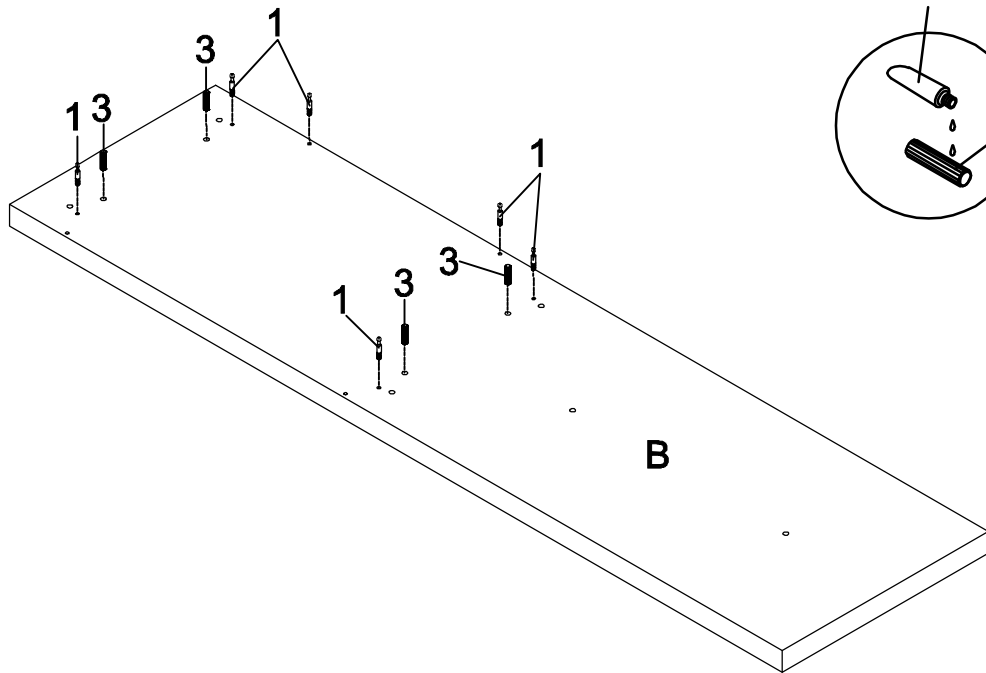

STEP 2

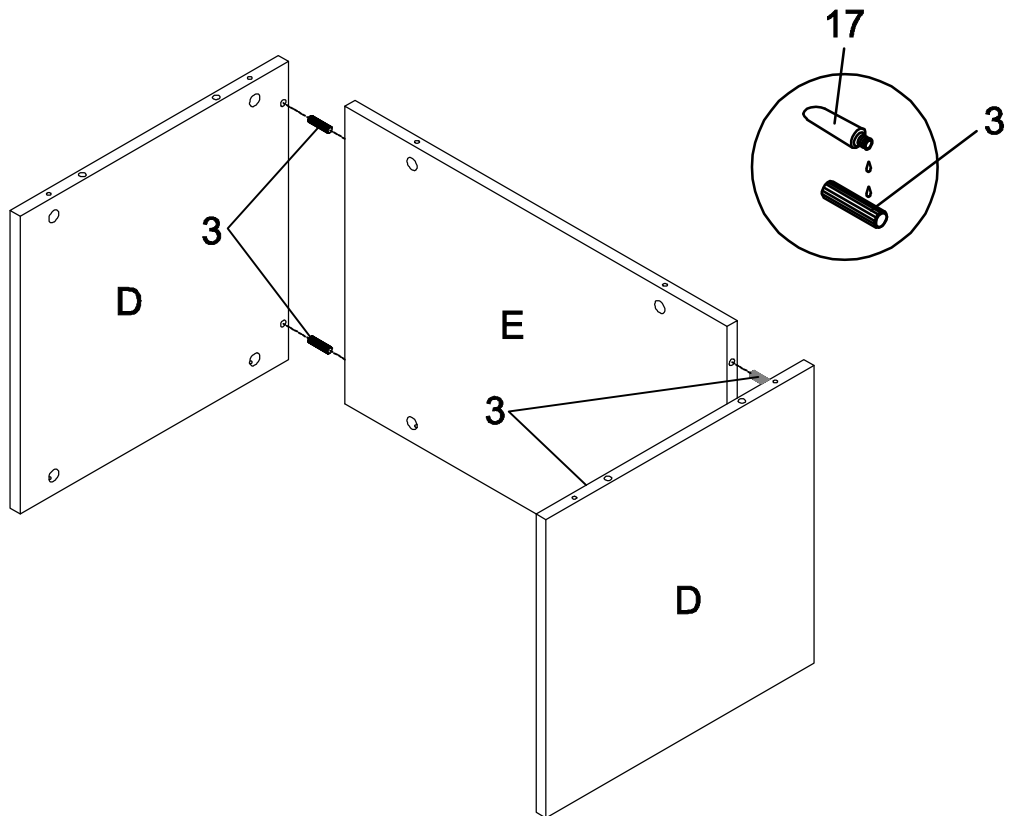

ITEM:182799
ASSEMBLY INSTRUCTIONS
STEP 3

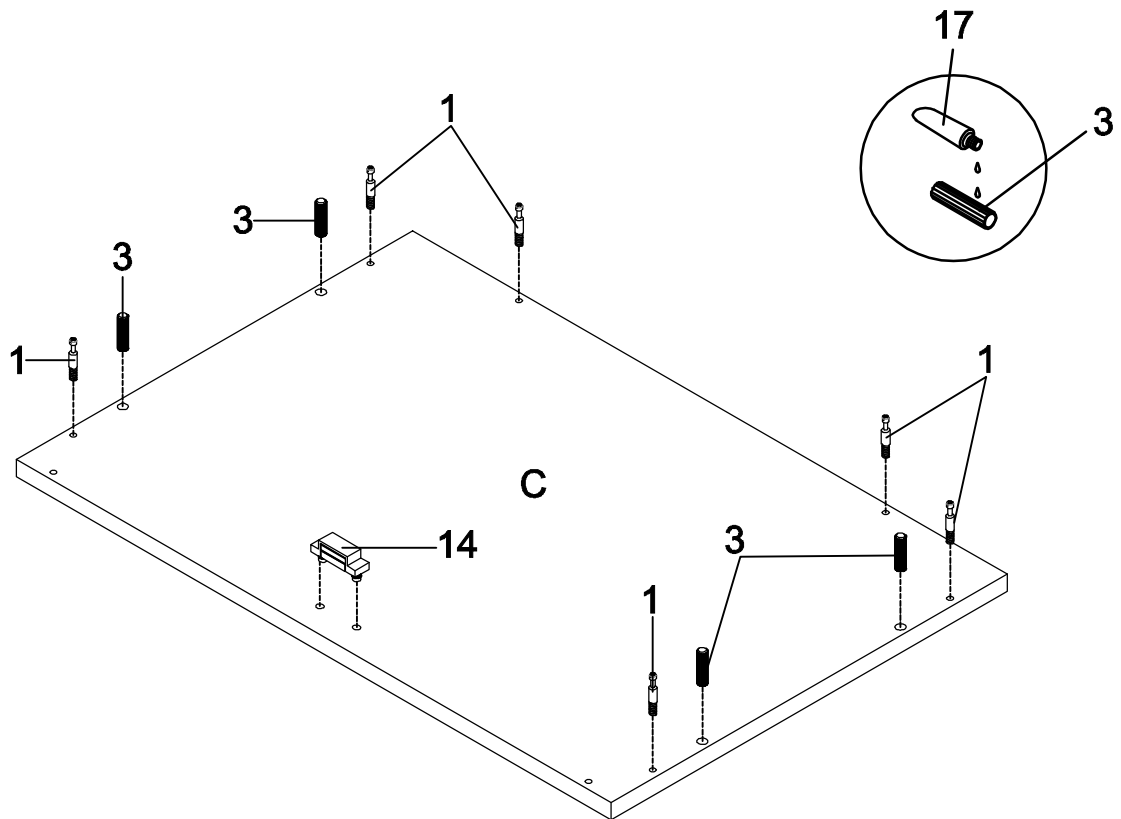

STEP 4

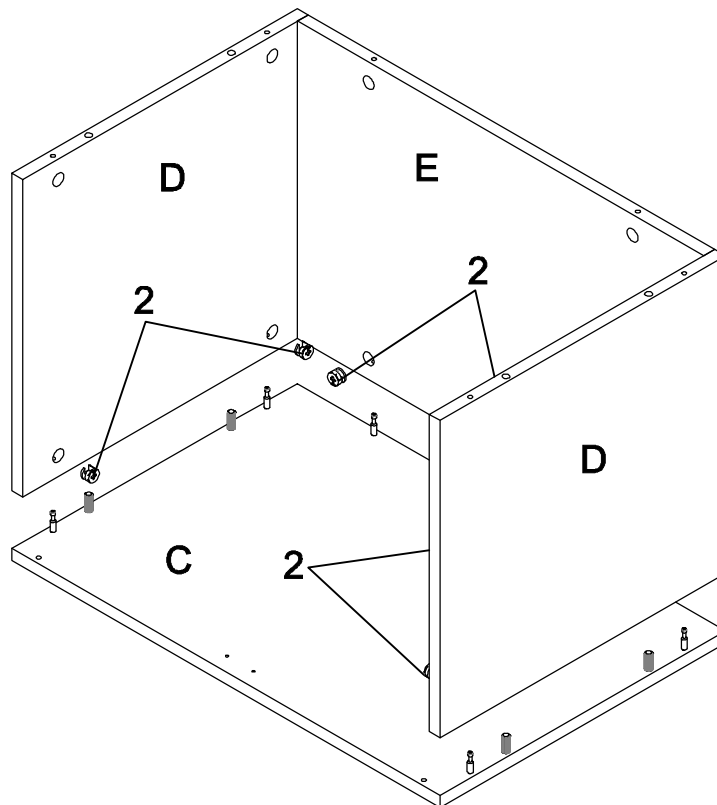

ITEM:182799

ASSEMBLY INSTRUCTIONS

STEP 5

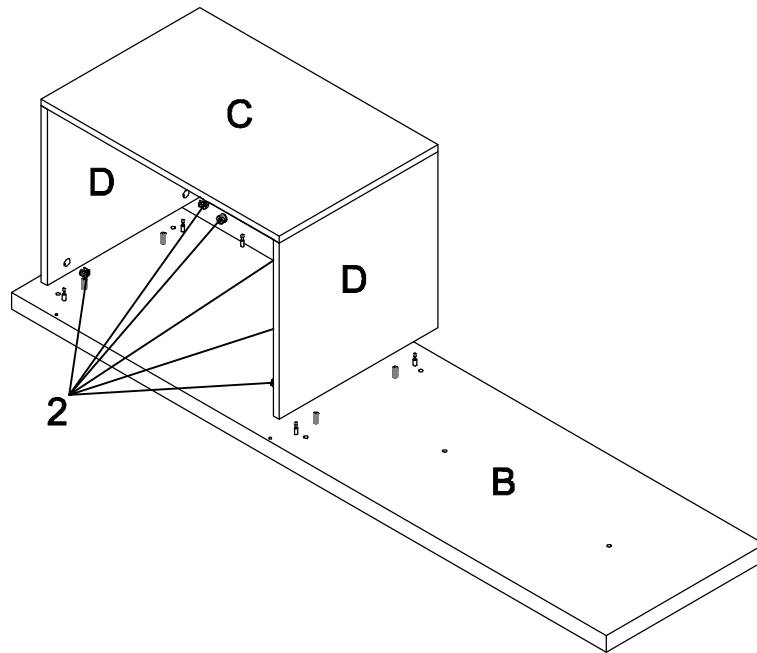

STEP 6

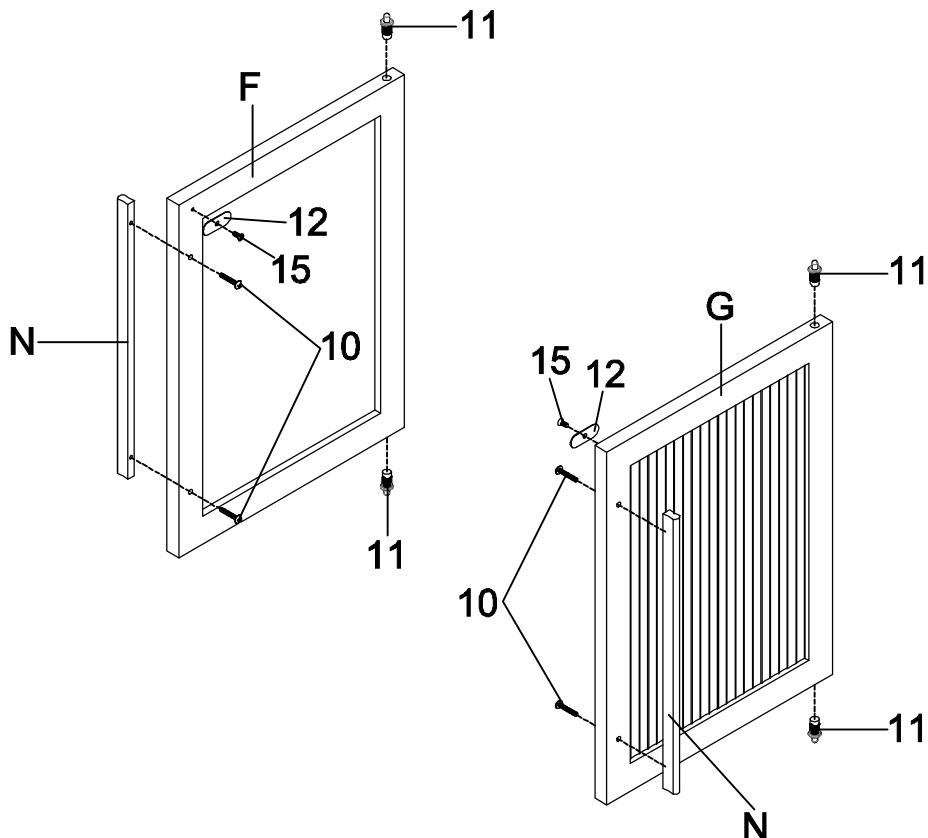

ITEM:182799

ASSEMBLY INSTRUCTIONS

STEP 7

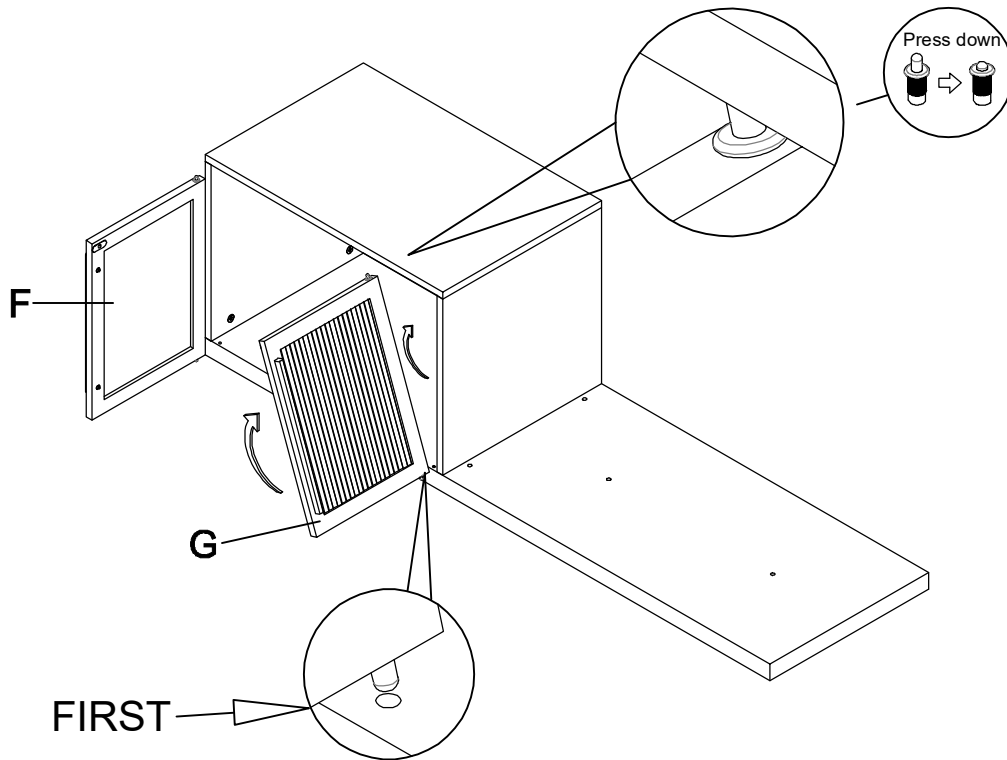

STEP 8

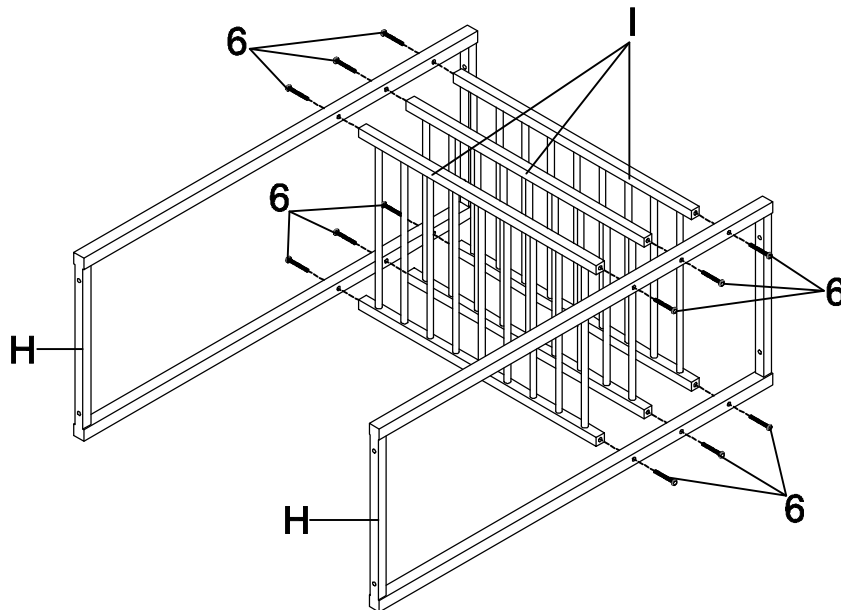

ITEM: 182799
ASSEMBLY INSTRUCTIONS
STEP 9

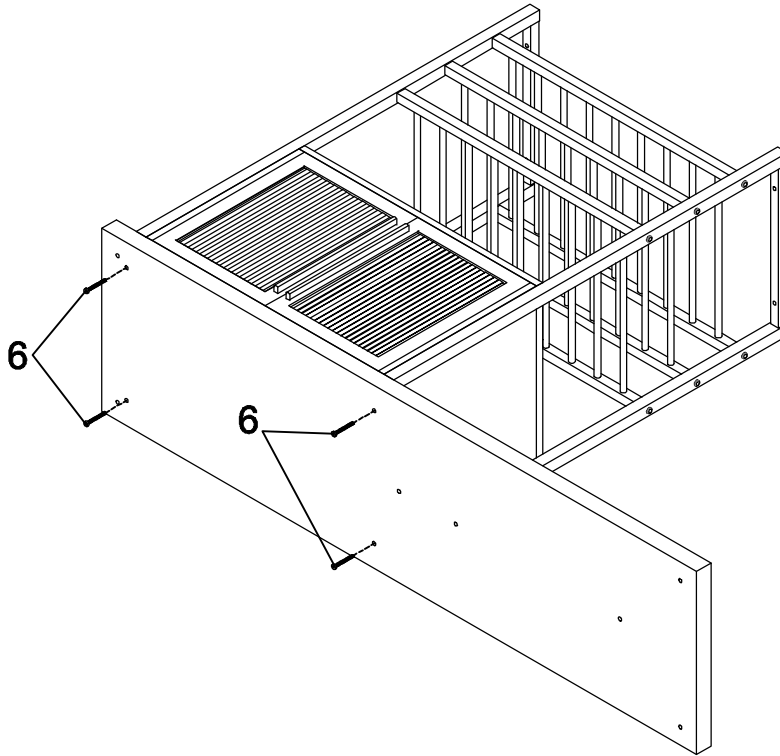

STEP 10

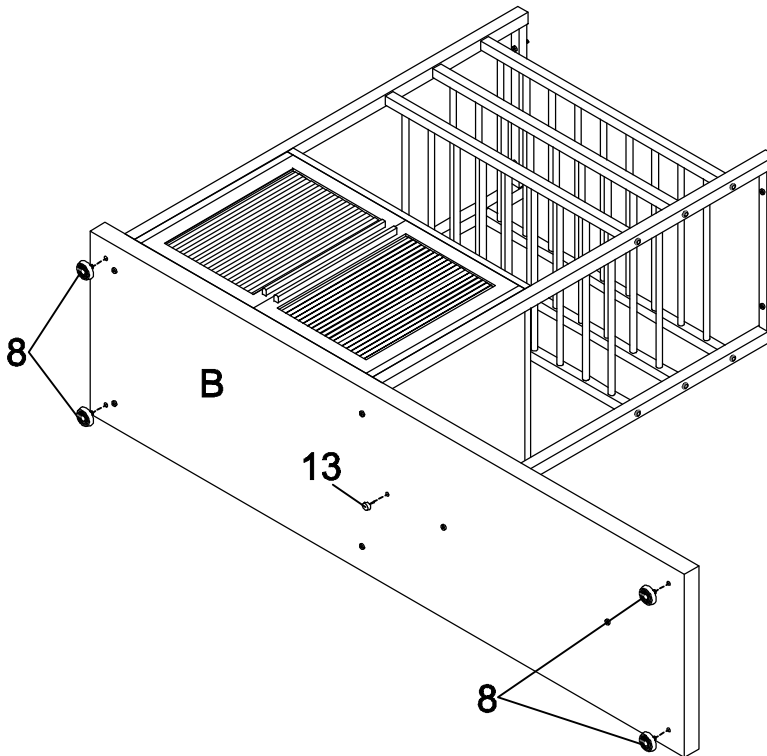

ITEM:182799
ASSEMBLY INSTRUCTIONS
STEP 11

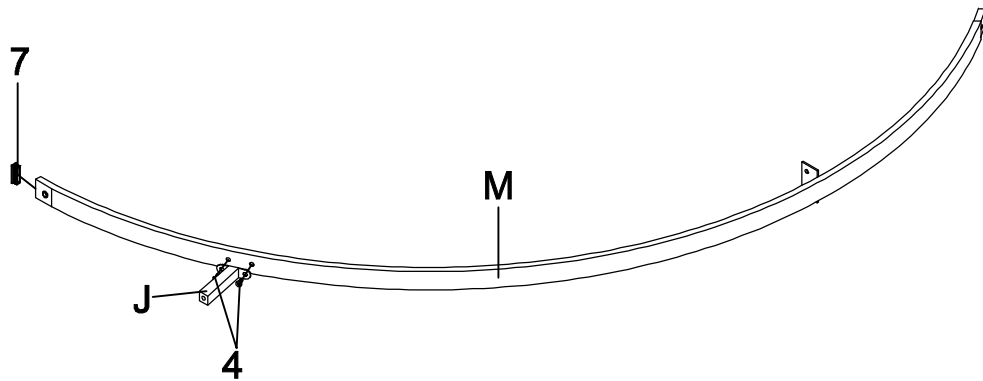

STEP 12

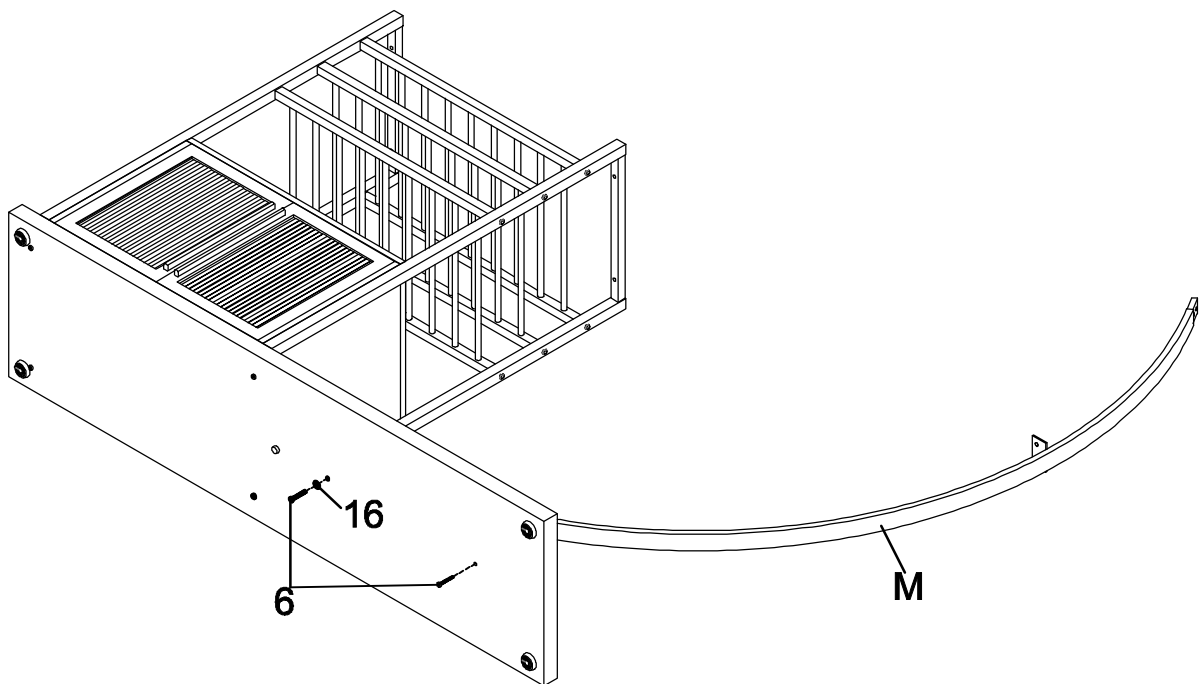

ITEM:182799 ASSEMBLY INSTRUCTIONS



STEP 13

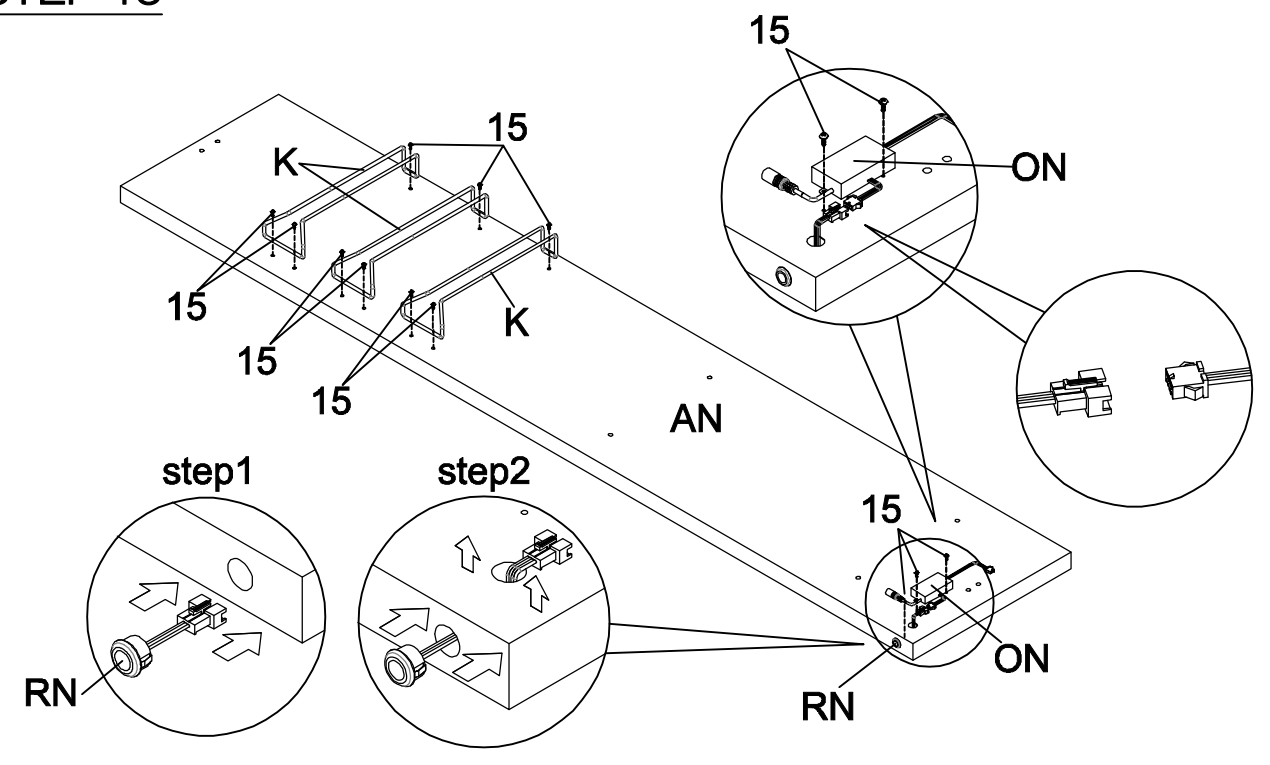

STEP 14

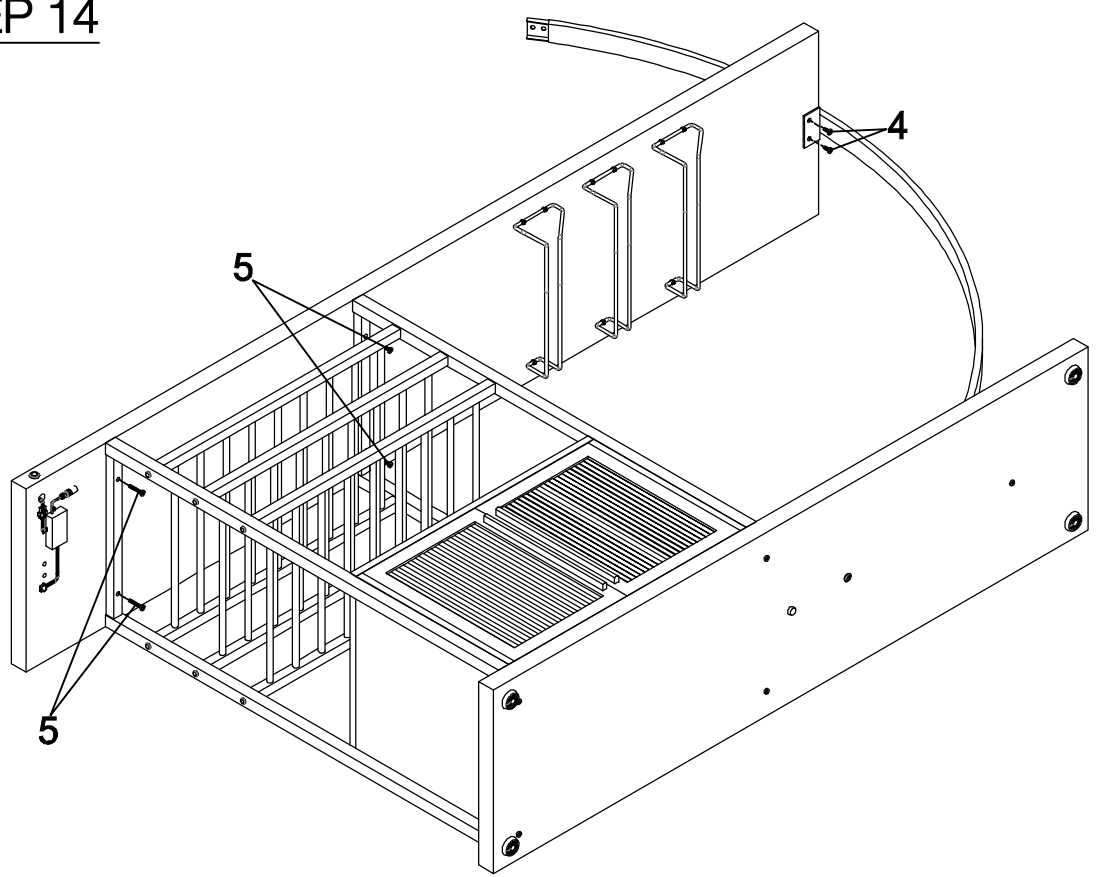

ITEM:182799
ASSEMBLY INSTRUCTIONS
STEP 15

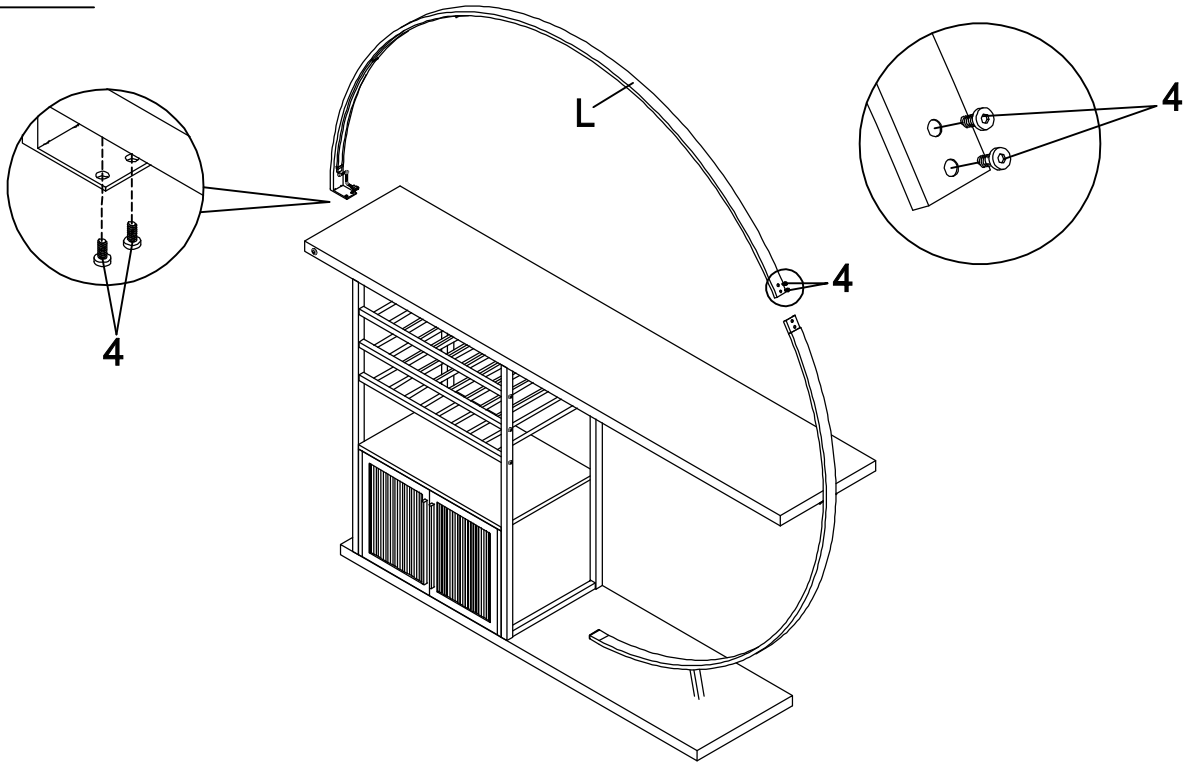

STEP 16

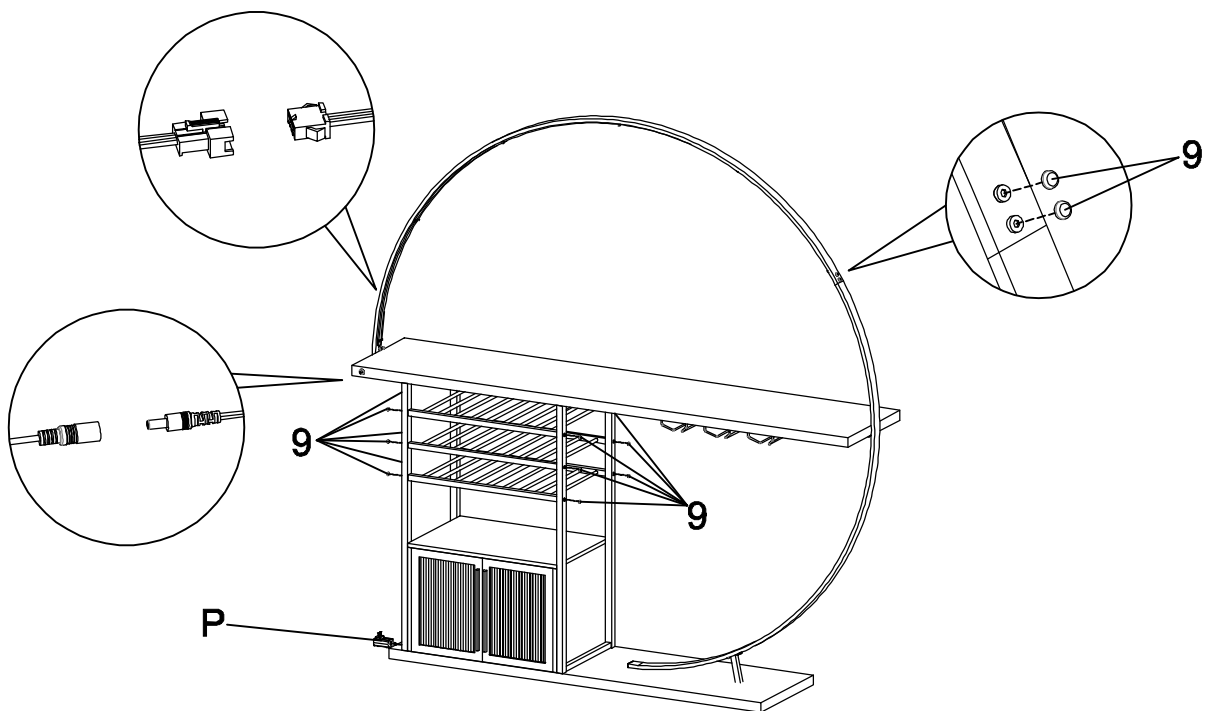

ITEM:182799
ASSEMBLY INSTRUCTIONS
STEP 17

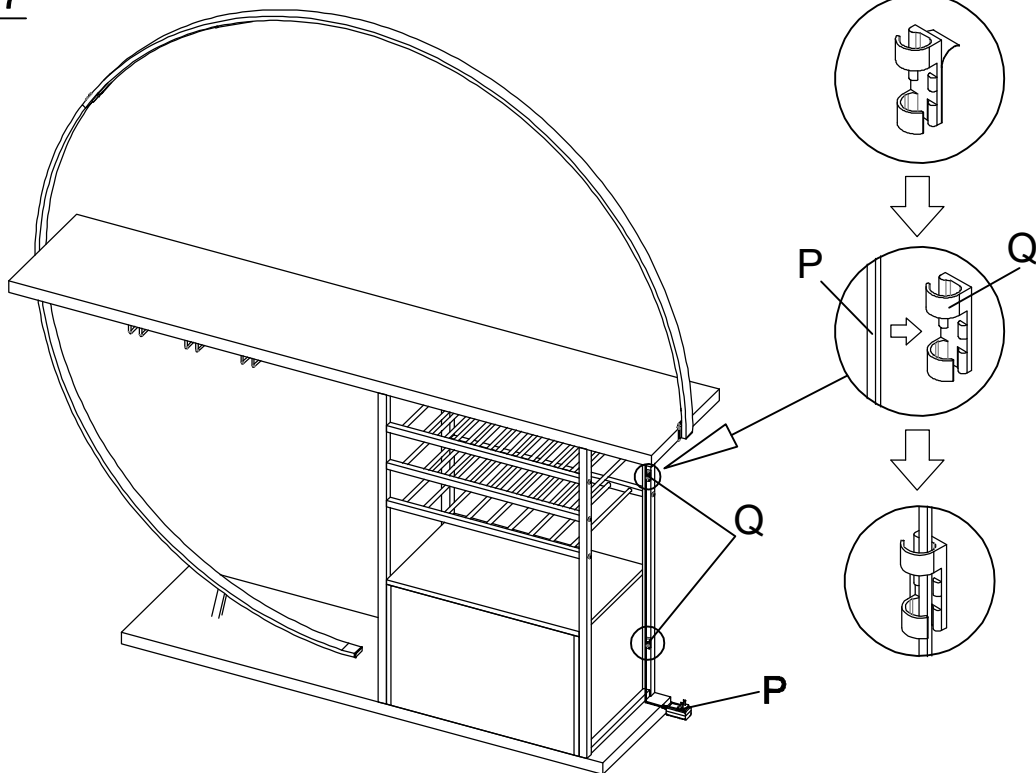

STEP 18
COMPLETE

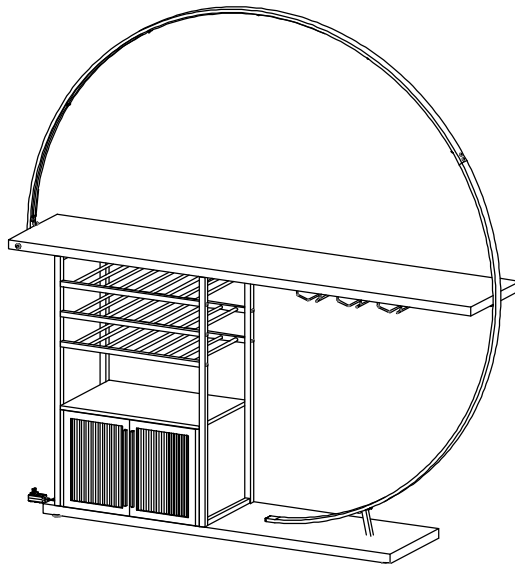

LED light operation guide

- Connect the power source using the provided cable
- Touch the metal plate to activate the LED lights
- Color Mode-Light blue purple, orange, red, yellow, green, light blue, dark blue, and purple
- Press once to change color
- Long Press to adjust the brightness
- Continue cycle through for twinkle light speed

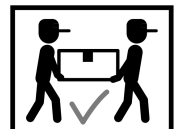

ITEM:182799
ASSEMBLY INSTRUCTIONS
STEP 17



Product Size : 1842 X 413 X 1905 H (MM)
Product Size : 72.5" X 16.25" X 75"

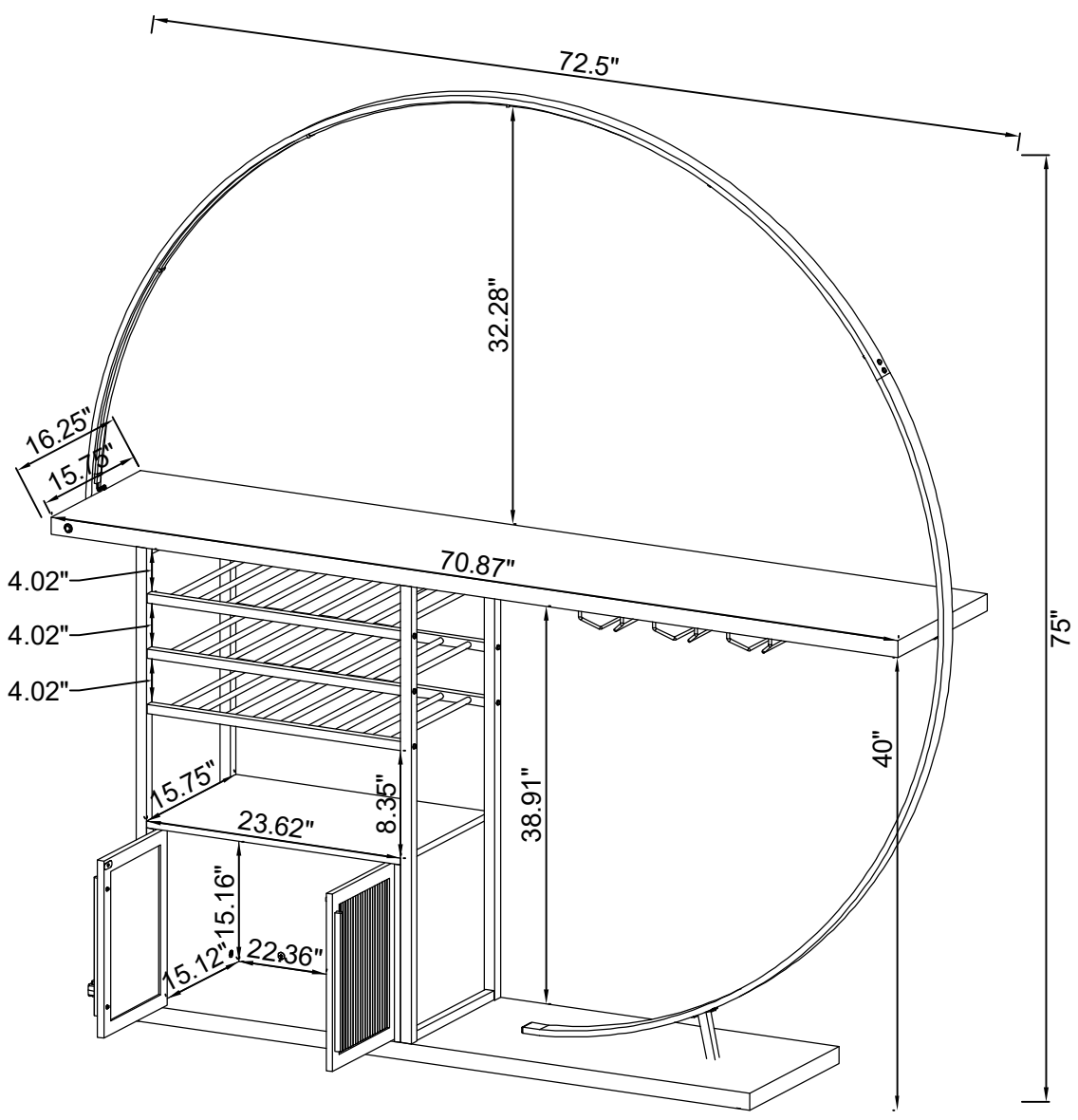

Note : Dimension tolerance $\pm 5\%$

ITEM: **182799**



ANTI-TIPPING INSTALLMENT INSTRUCTIONS

FURNITURE TIPPING RESTRAINT

WARNING

Injury may result from tipping furniture.
This restraint may protect against tipping furniture.
Do not allow children to climb on furniture.
This restraint is not a substitute for proper adult supervision.
Failure to detach this restraint before moving the furniture may result in injury and damage.

This tip restraint must be attached to a wall stud using long screw enclosed.

STEP 1

Attach a bracket securely to the back top rail of the furniture using short screw provided, through the smaller hole.

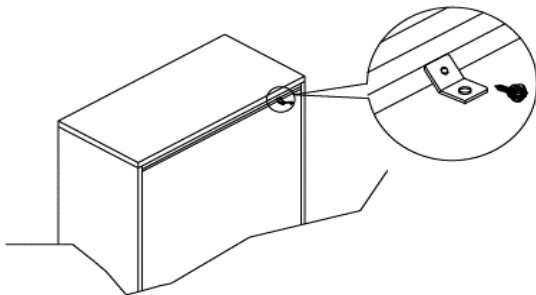

STEP 2

Locate the other bracket on the wall over a plastic wall stud and two inches below the mounting bracket secured to the back of the furniture. Attach the wall stud using the long screw provided, through the smaller hole.

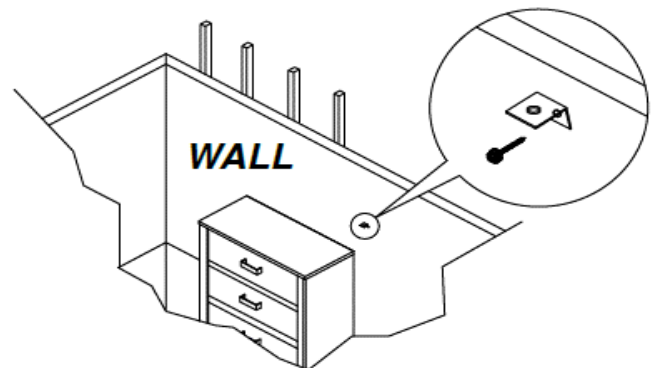

STEP 3

Place the furniture into position so both mounting brackets are vertically in line. Lace the end of the restraint strap through the larger hole in each mounting bracket. Bring both ends together and slide the flat end through the locking end and draw it through until all slack is removed. Confirm that the strap is securely laced and locked.

