

*ASSEMBLY INSTRUCTIONS*  
*COASTER FINE FURNITURE*



*Fine Furniture for every stage of life*

**224308**  
**Vanity Mirror**

ITEM: **224308**



## ASSEMBLY INSTRUCTIONS

### ASSEMBLY TIPS:

1. Remove hardware from box and sort by size.
2. Please check to see that all hardware and parts are present prior to start of assembly.
3. Please follow attached instructions in the same sequence as numbered to assure fast & easy assembly.



### WARNING!



1. Don't attempt to repair or modify parts that are broken or defective. Please contact the store immediately.
2. This product is for home use only and not intended for commercial establishments.







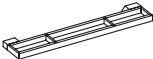

ASSEMBLY TIME

10 MINUTES

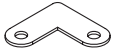
## PART IDENTIFICATION

A	MIRROR		1PC
B	JEWELRY TRAY		1PC
C	HANGING BAR		1PC

## HARDWARE IDENTIFICATION

1	METAL BRACKET (2.5 x 65 x 65mm - BLK)		2PCS
2	BOLT (M6 x 22mm - BLK)		4PCS
3	LOCK WASHER (1.6 x 14mm - BLK)		4PCS
4	FLAT WASHER (1 x 18mm - BLK)		4PCS
5	ALLEN WRENCH (M4 x 65mm - BLK)		1PC
6	PAN HEAD SCREW (8 x 2" - BLK)		6PCS
7	PLASTIC ANCHOR (S8 - GREY)		6PCS

ITEM: **224308**  
**ASSEMBLY INSTRUCTIONS**

**STEP 1**

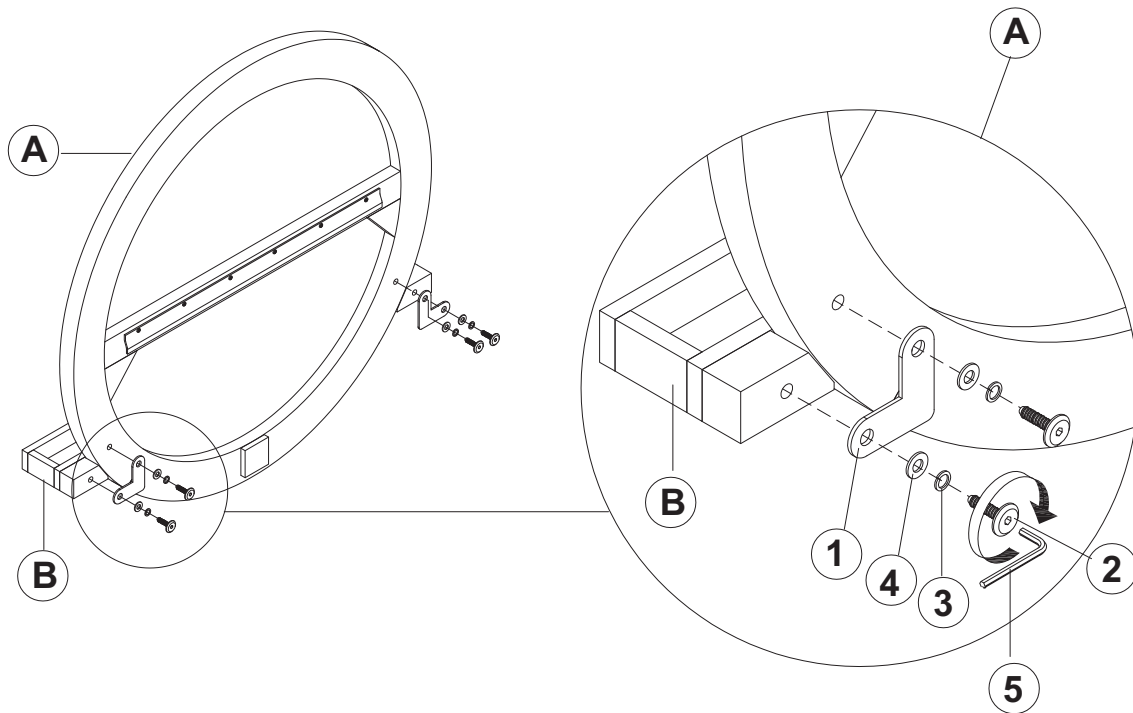

**BACK VIEW**

**STEP 2**

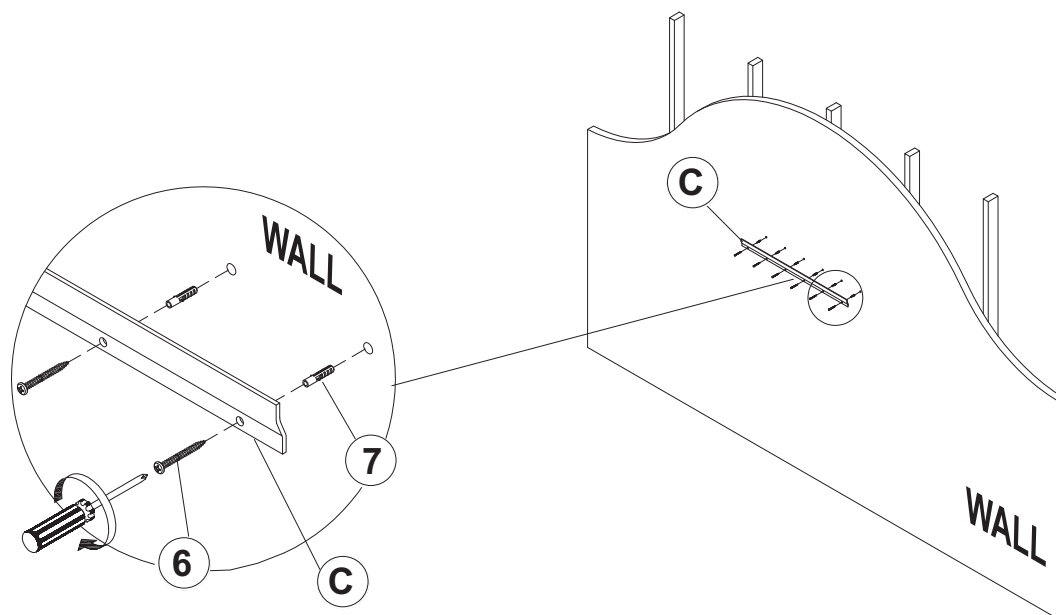

ITEM: **224308**

**ASSEMBLY INSTRUCTIONS**



**STEP 3**

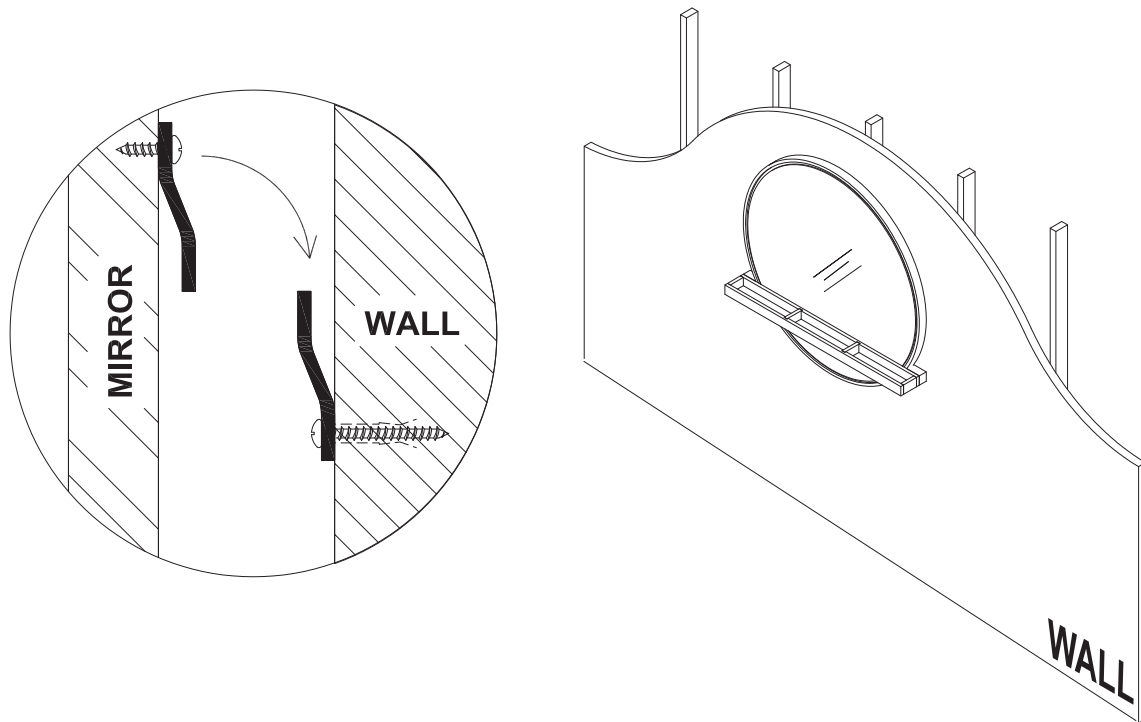

**STEP 4**  
**COMPLETE**

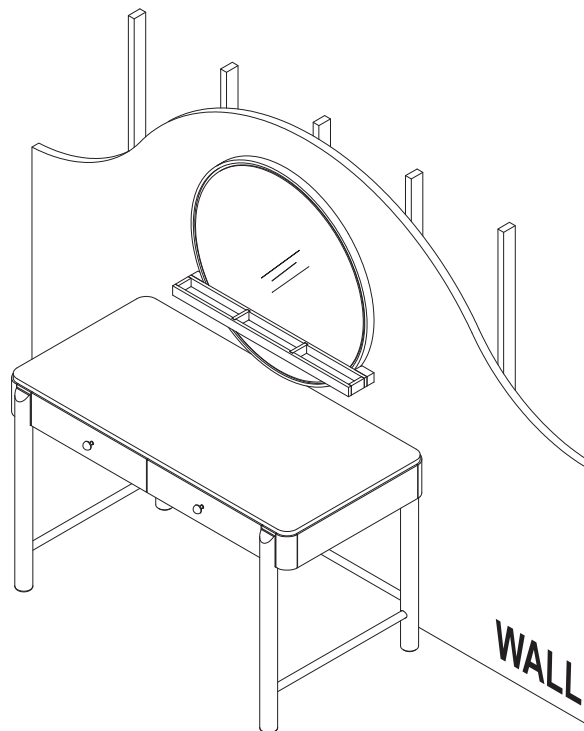

ITEM: 224308

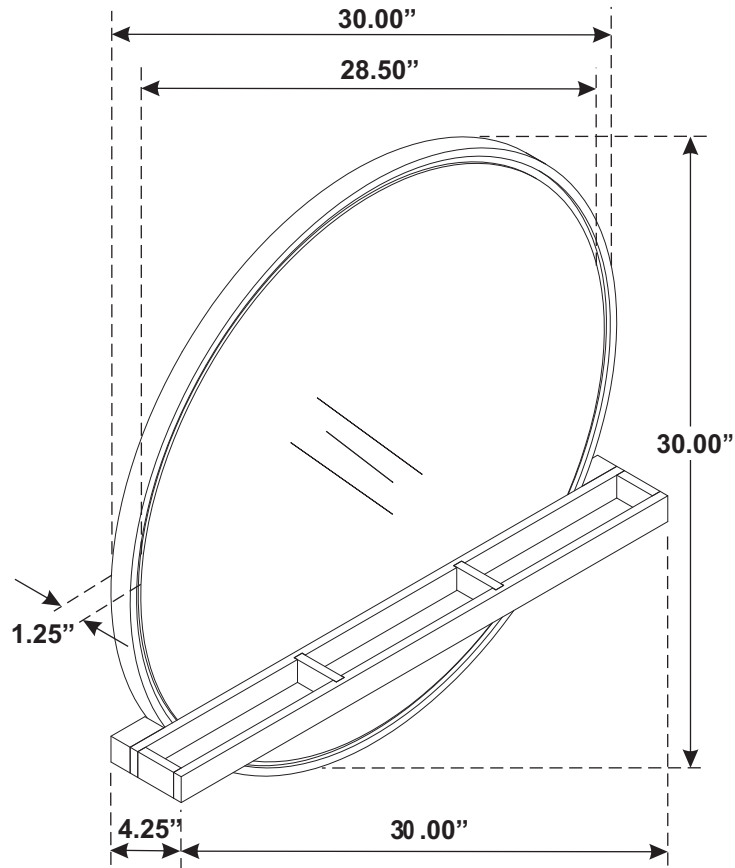

**Note: Dimension tolerance  $\pm 5\%$**