

ASSEMBLY INSTRUCTIONS
COASTER FINE FURNITURE



Fine Furniture for every stage of life

181025
SERVING CART

REVISION 0 : 09/08/2023
REVISION 1 : 04/18/2024

ITEM:181025



ASSEMBLY INSTRUCTIONS

ASSEMBLY TIPS:

1. Remove hardware from box and sort by size.
2. Please check to see that all hardware and parts are present prior to start of assembly.
3. Please follow attached instructions in the same sequence as numbered to assure fast & easy assembly.



WARNING!

1. Don't attempt to repair or modify parts that are broken or defective. Please contact the store immediately.
2. This product is for home use only and not intended for commercial establishments.

ASSEMBLY TIME 65 MINUTES

PARTS IDENTIFICATION

A	TOP TRAY		1PC
B	BOTTOM TRAY		1PC
C	LEFT PANEL		1PC
D	RIGHT PANEL		1PC
E	BACK PANEL		1PC

ITEM:181025

ASSEMBLY INSTRUCTIONS

PARTS IDENTIFICATION



F

DRAWER FRONT PANEL

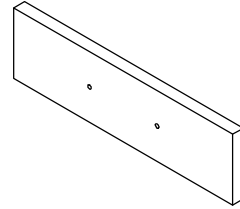

1PC

G

DRAWER LEFT PANEL

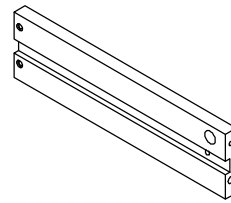

1PC

H

DRAWER RIGHT PANEL

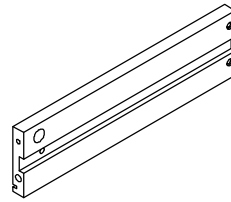

1PC

I

DRAWER BACK PANEL

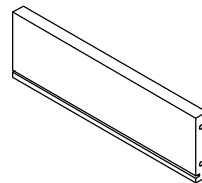

1PC

J

DRAWER BOTTOM PANEL

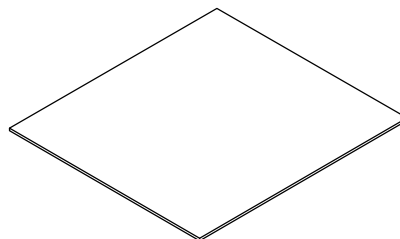

1PC

K

LEG 1

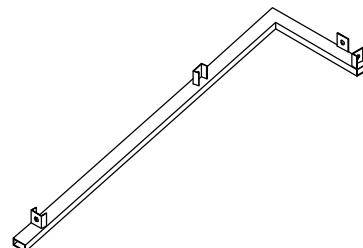

2PCS

ITEM:181025

ASSEMBLY INSTRUCTIONS

PARTS IDENTIFICATION



L

LEG 2

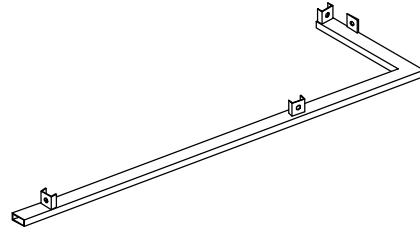

2PCS

M

TOP CROSSBAR

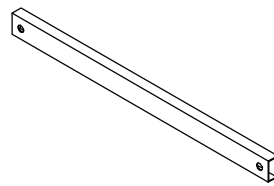

1PC

N

MIDDLE CROSSBAR

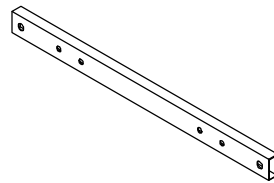

2PCS

O

BOTTOM CROSSBAR

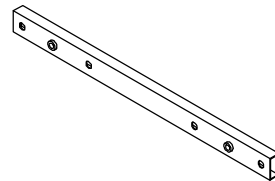

2PCS

P

HANDLE

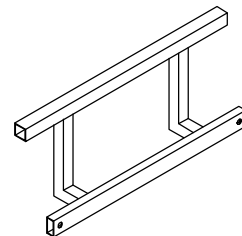

1PC

Q

HOLDER

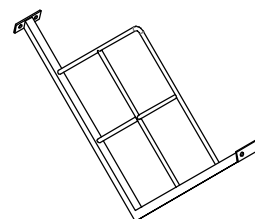

2PCS

ITEM:181025

ASSEMBLY INSTRUCTIONS



R DRAWER HANDLE

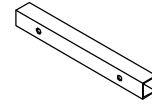

1PC

S SLIDE RAIL

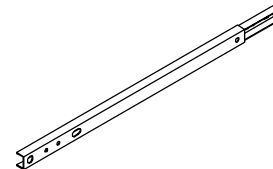

2PCS

T WHEEL



4PCS

HARDWARE IDENTIFICATION

1 CAM BOLT (38mm)  6PCS

2 CAM LOCK (φ15mm)  6PCS

3 WOOD DOWEL (8 x 30mm)  10PCS

4 WOOD SCREW (8 x 38mm)  4PCS

5 HANDLE BOLT (5/32" x 22mm)  2PCS

6 SMALL BOLT (5/32" x 12mm)  2PCS

7 SCREW (3 x 8mm)  6PCS

8 SHORT BOLT (1/4" x 12mm SR)  16PCS

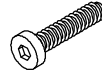
9 LONG BOLT (1/4" x 21mm SR)  4PCS

10 CAP (13 x 26mm SR)  8PCS

11 DRAWER HANDLE CAP (16 x 16mm SR)  2PCS

12 HANDLE CAP (20 x 20mm SR)  2PCS

13 GLUE  1PC

14 HOLDER BOLT (3/16" x 12mm SR)  8PCS

15 ALLEN WRENCH (4mm)  1PC

16 HEXAGONAL KEY (8mm)  1PC

ITEM:181025



ASSEMBLY INSTRUCTIONS

STEP 1 Do not tighten until each step is completed or instructed.

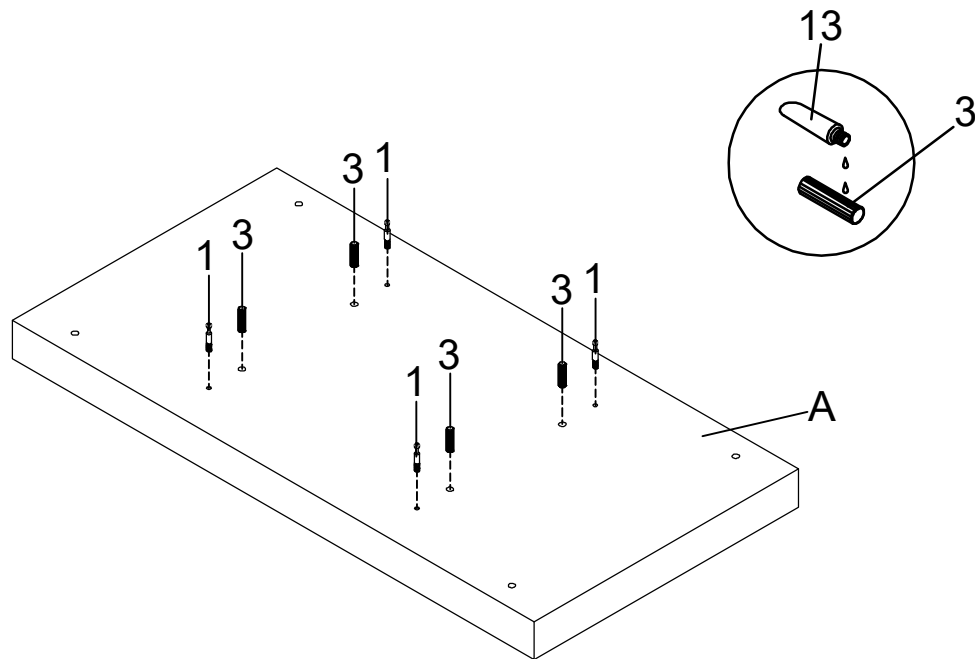

STEP 2

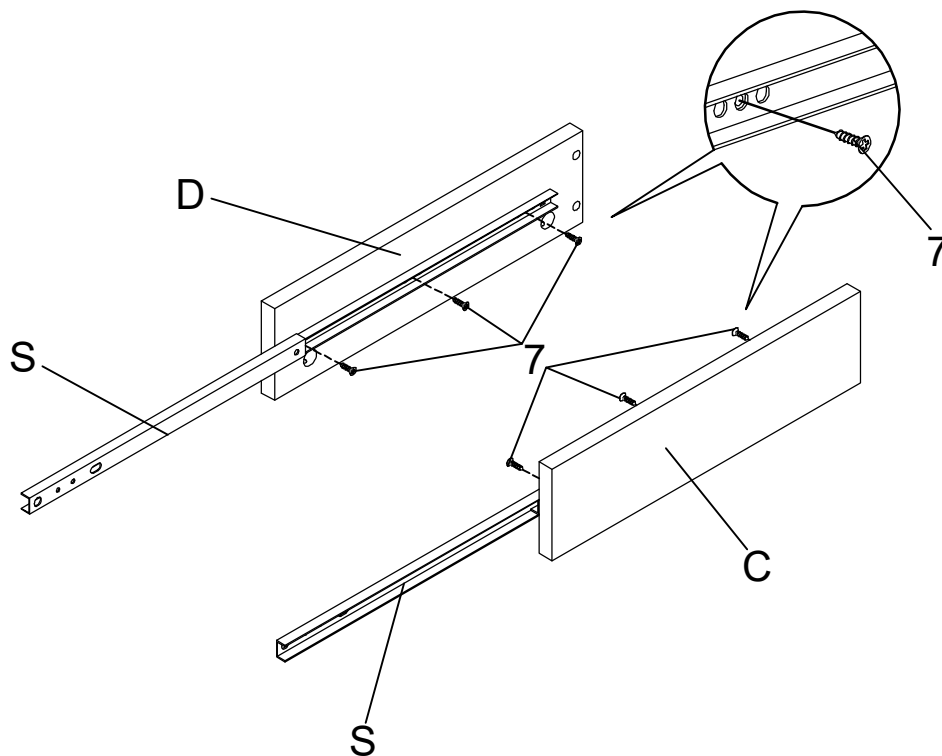

ITEM:181025
ASSEMBLY INSTRUCTIONS
STEP 3

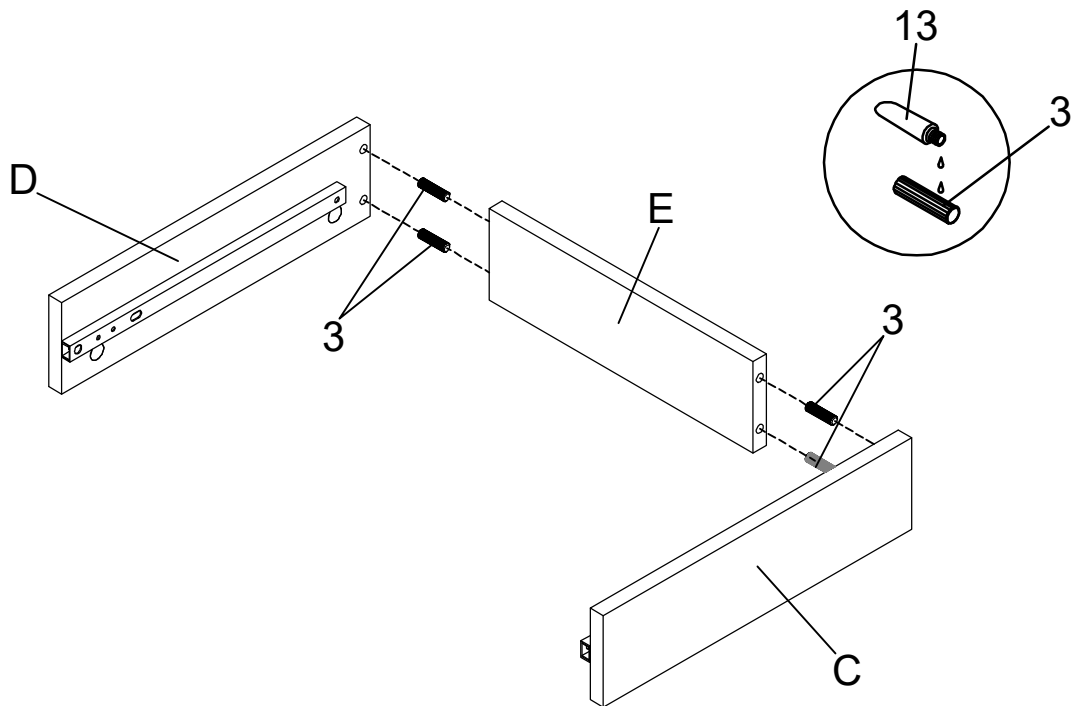

STEP 4

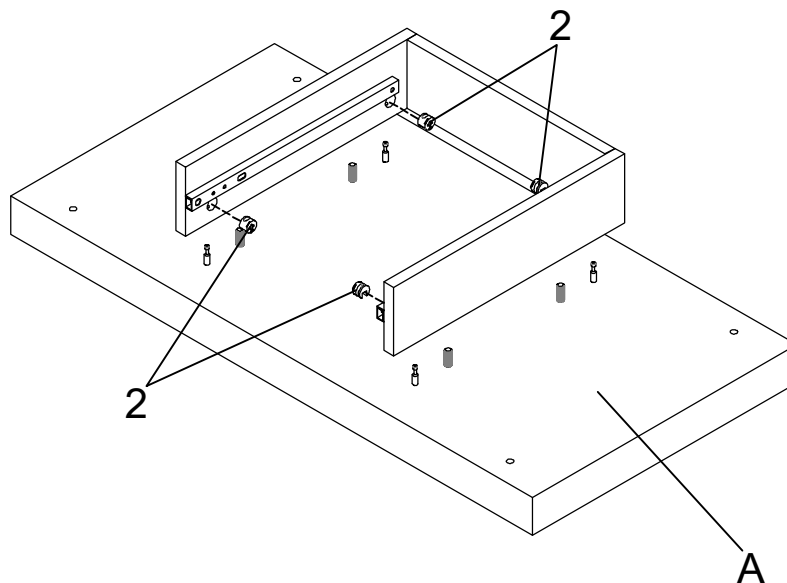

ITEM:181025

ASSEMBLY INSTRUCTIONS

STEP 5

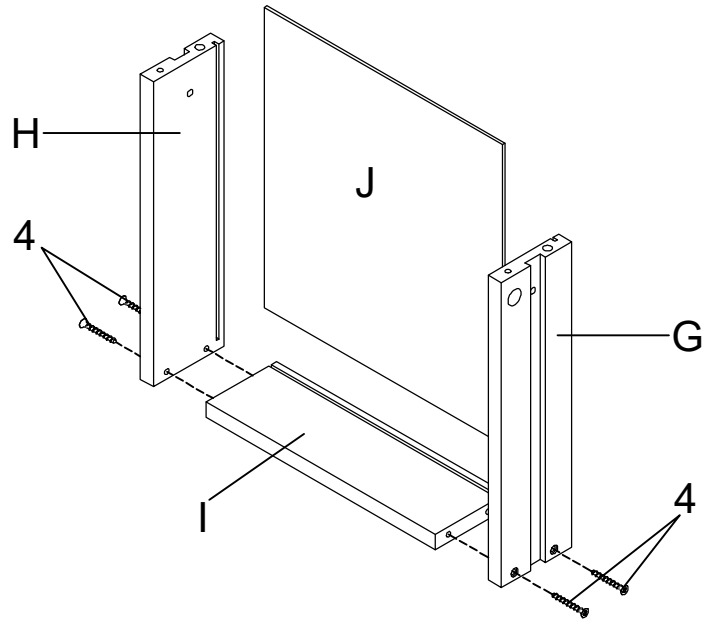

STEP 6

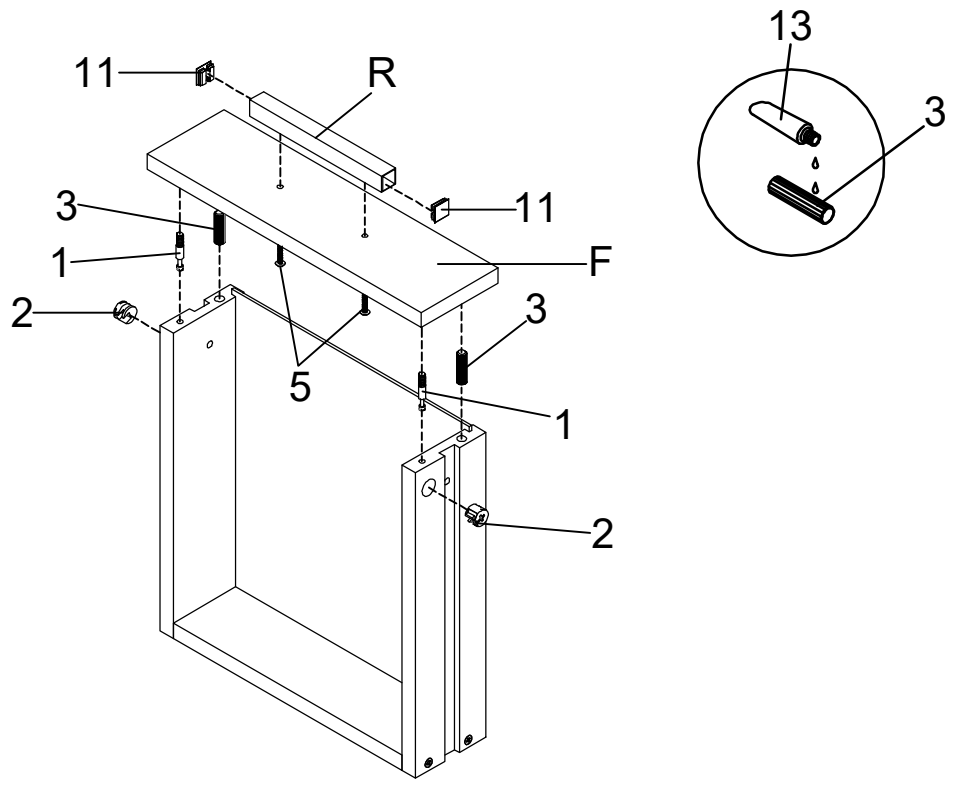

ITEM:181025

ASSEMBLY INSTRUCTIONS

STEP 7

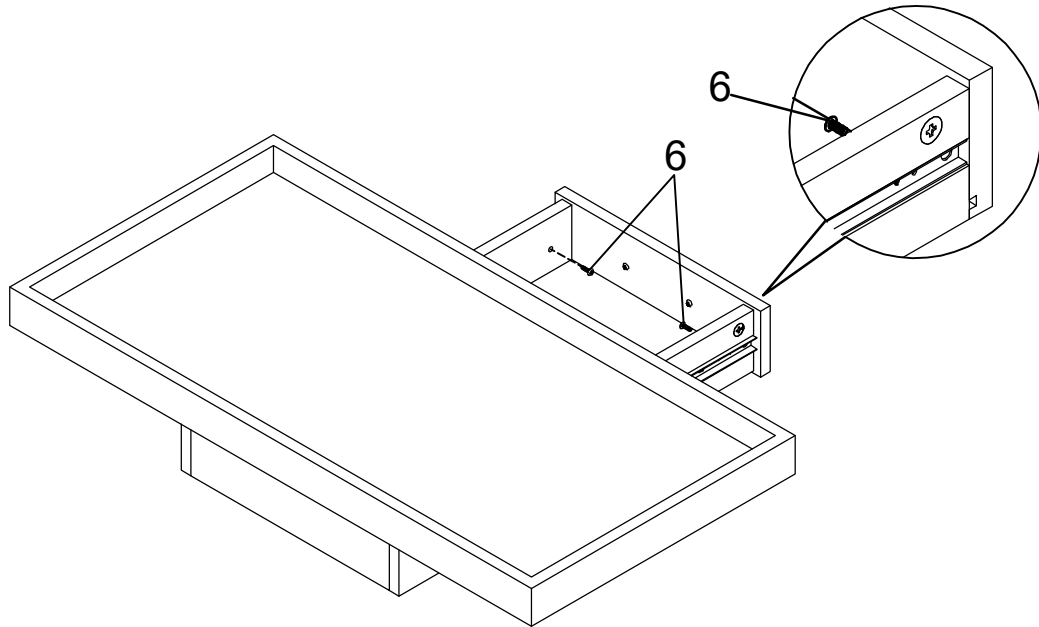

STEP 8

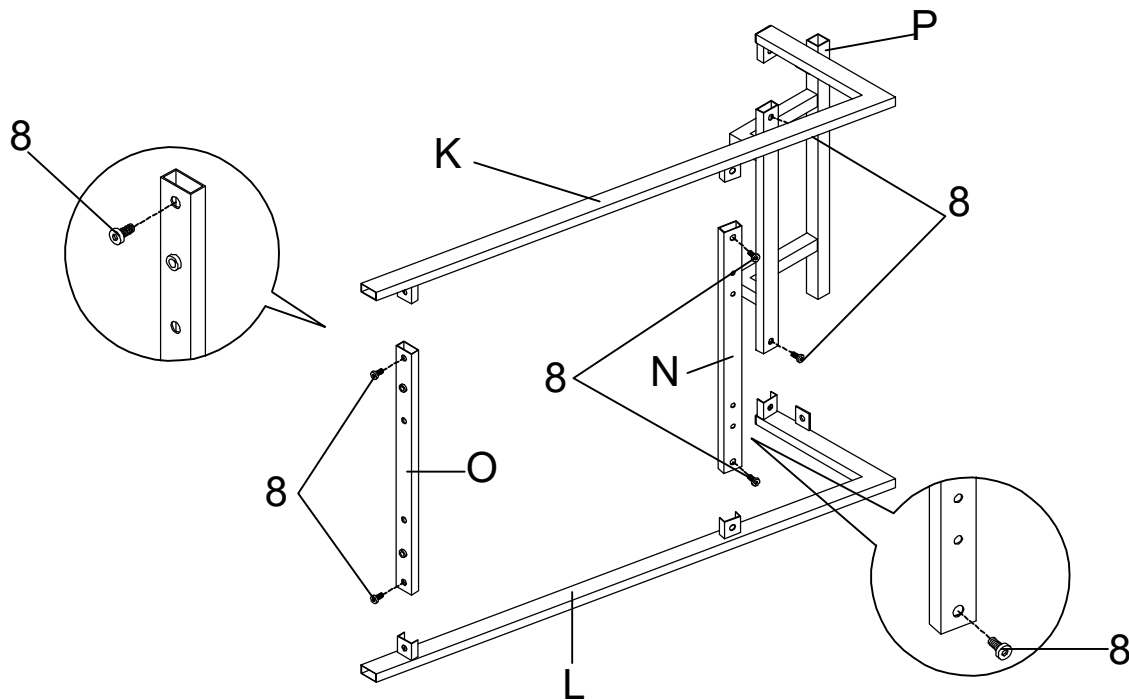

ITEM:181025
ASSEMBLY INSTRUCTIONS
STEP 9

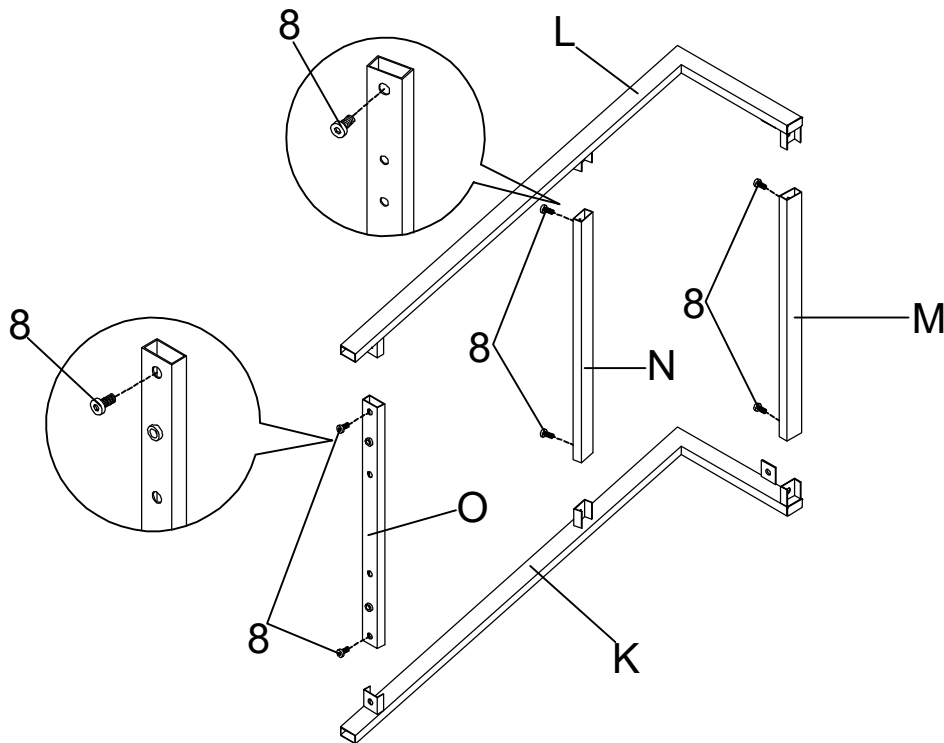

STEP 10

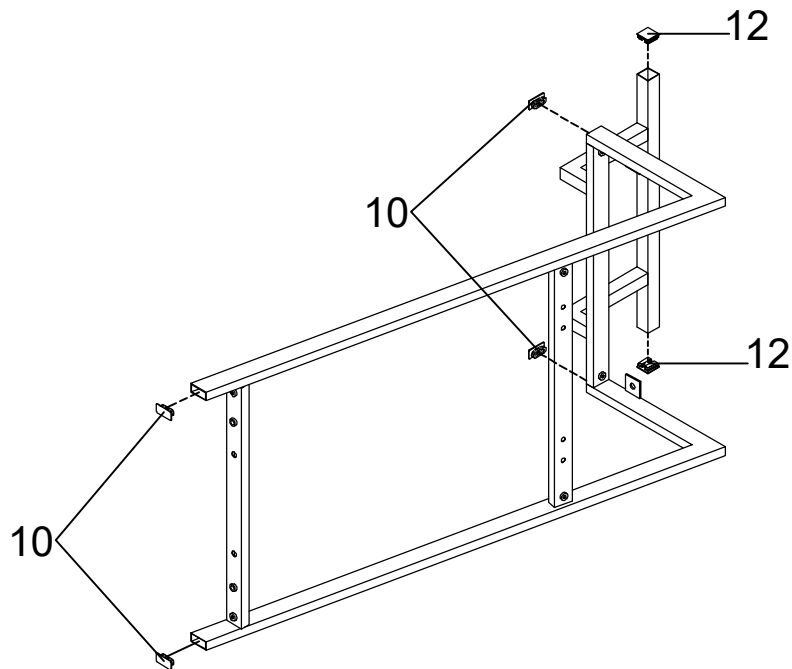

ITEM:181025
ASSEMBLY INSTRUCTIONS
STEP 11

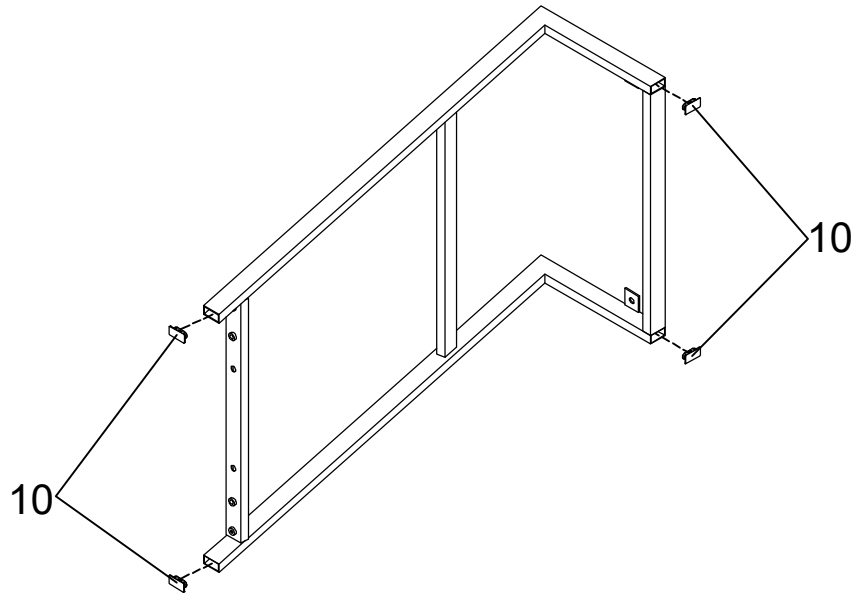

STEP 12

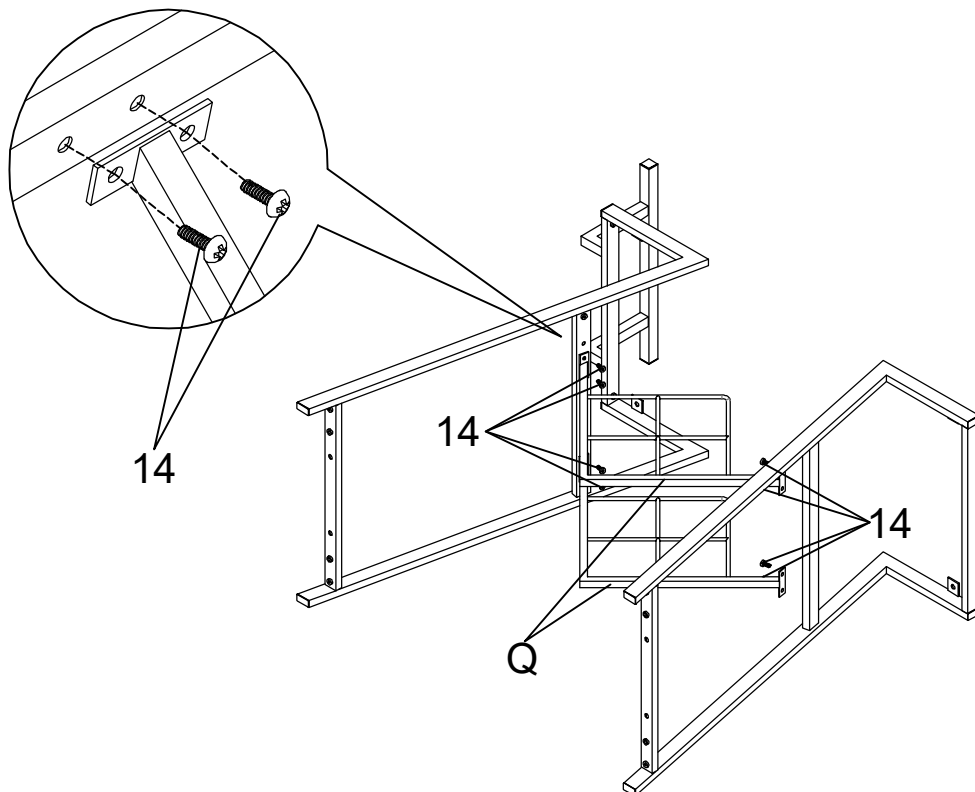

ITEM:181025
ASSEMBLY INSTRUCTIONS
STEP 13

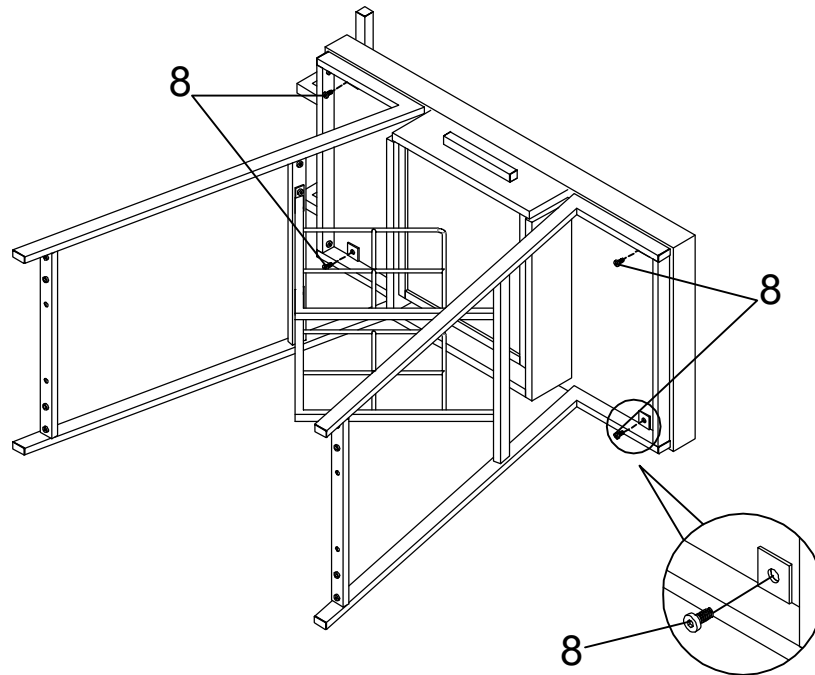

STEP 14

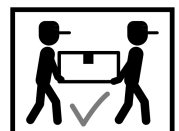
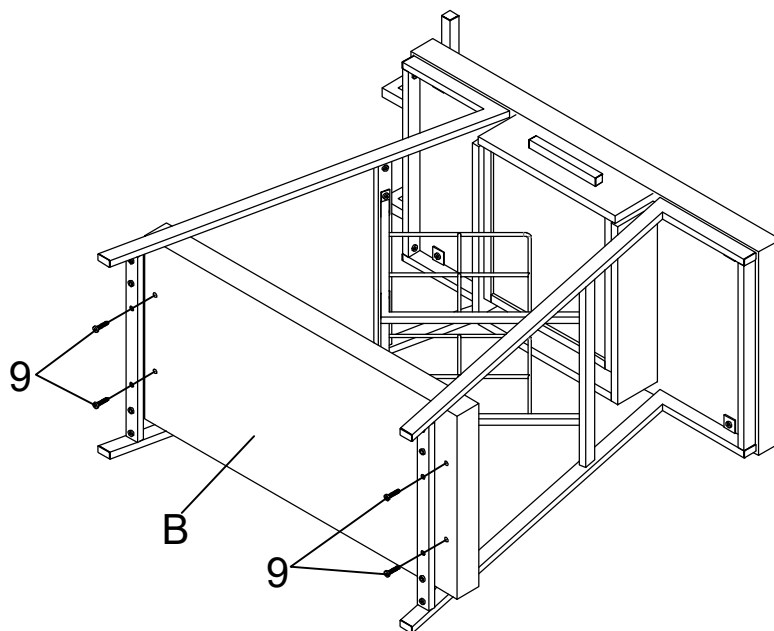

ITEM:181025
ASSEMBLY INSTRUCTIONS
STEP 15

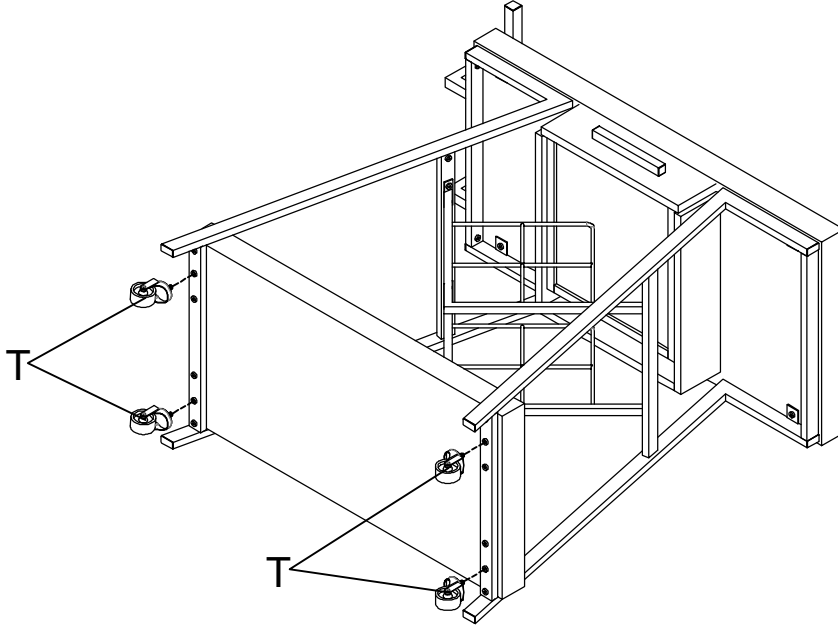

STEP 16
COMPLETE

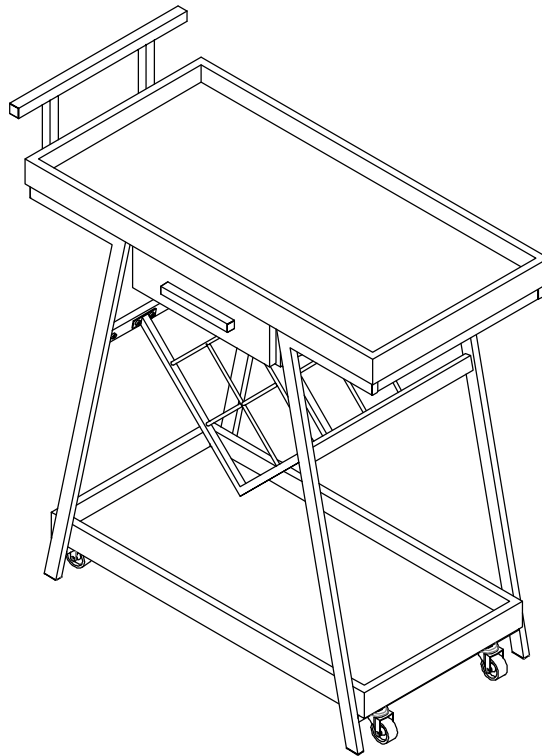

ITEM:181025 ASSEMBLY INSTRUCTIONS



Product Size : 826 X 400 X 889 H (MM)
Product Size : 32.5" X 15.75" X 35"

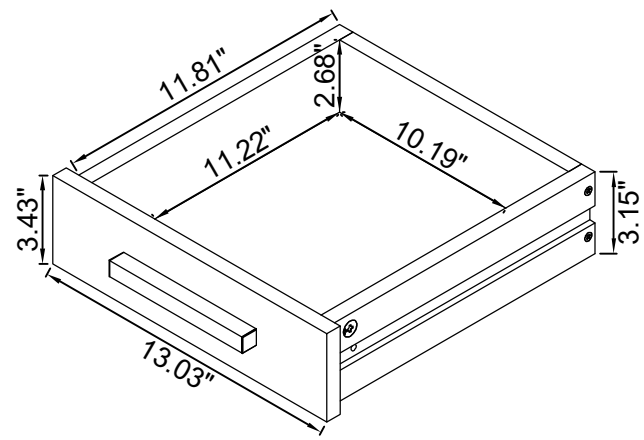
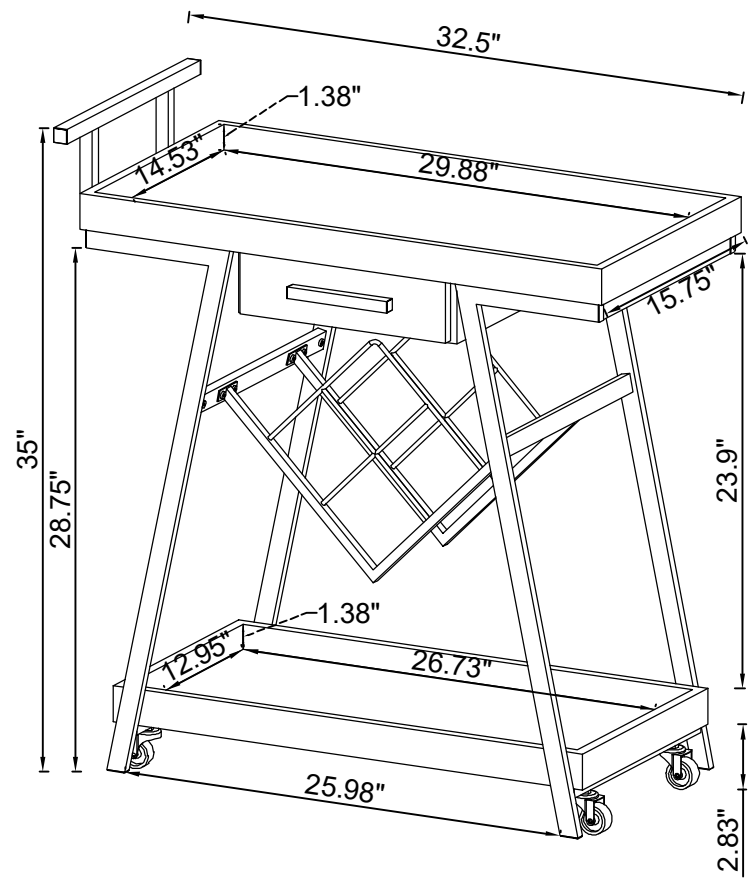

Note : Dimension tolerance $\pm 5\%$