

ITEM: 903168

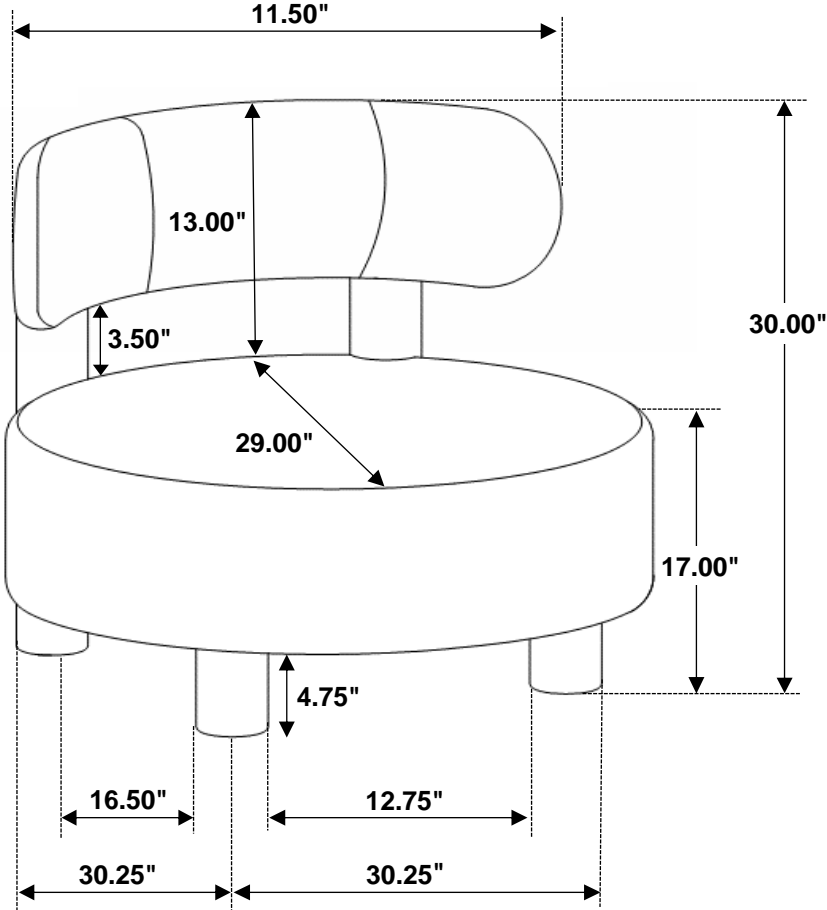

Note: Dimension tolerance $\pm 5\%$