

ASSEMBLY INSTRUCTIONS
COASTER FINE FURNITURE



Fine Furniture for every stage of life

710517
END TABLE

ITEM:710517

ASSEMBLY INSTRUCTIONS

ASSEMBLY TIPS:

1. Remove hardware from box and sort by size.
2. Please check to see that all hardware and parts are present prior to start of assembly.
3. Please follow attached instructions in the same sequence as numbered to assure fast & easy assembly.



WARNING!

1. Don't attempt to repair or modify parts that are broken or defective. Please contact the store immediately.
2. This product is for home use only and not intended for commercial establishments.



ASSEMBLY TIME

30 MINUTES

PARTS IDENTIFICATION

A SIDE PANEL

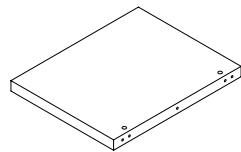

2 PCS

C TOP PANEL

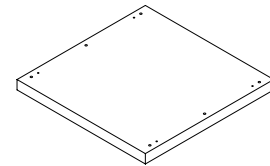



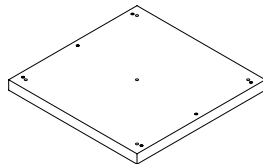

1 PC

B BOTTOM PANEL

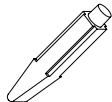
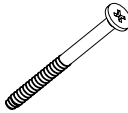
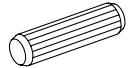

1 PC

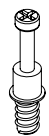
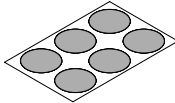
HARDWARE IDENTIFICATION

Z							
NO	DESCRIPTION	FIGURE	Q'TY	NO	DESCRIPTION	FIGURE	Q'TY
1	GLUE 15g		1 PC	5	BOLT Ø9.5x55mm SR		6 PCS
2	WOODEN DOWEL Ø8x30mm		10 PCS	6	FOOT Ø35xH19mm		4 PCS
3	CAM BOLT Ø7x35.5mm SR		4 PCS	7	STICKER Ø20mm		1 PC
4	CAM LOCK Ø15x12mm SR		4 PCS				

NOTE:

Phillips head screw driver is required in the assembly process; however, manufacturer does not provide this item.

ITEM: 710517

COASTER
FINE FURNITURE

STEP 1

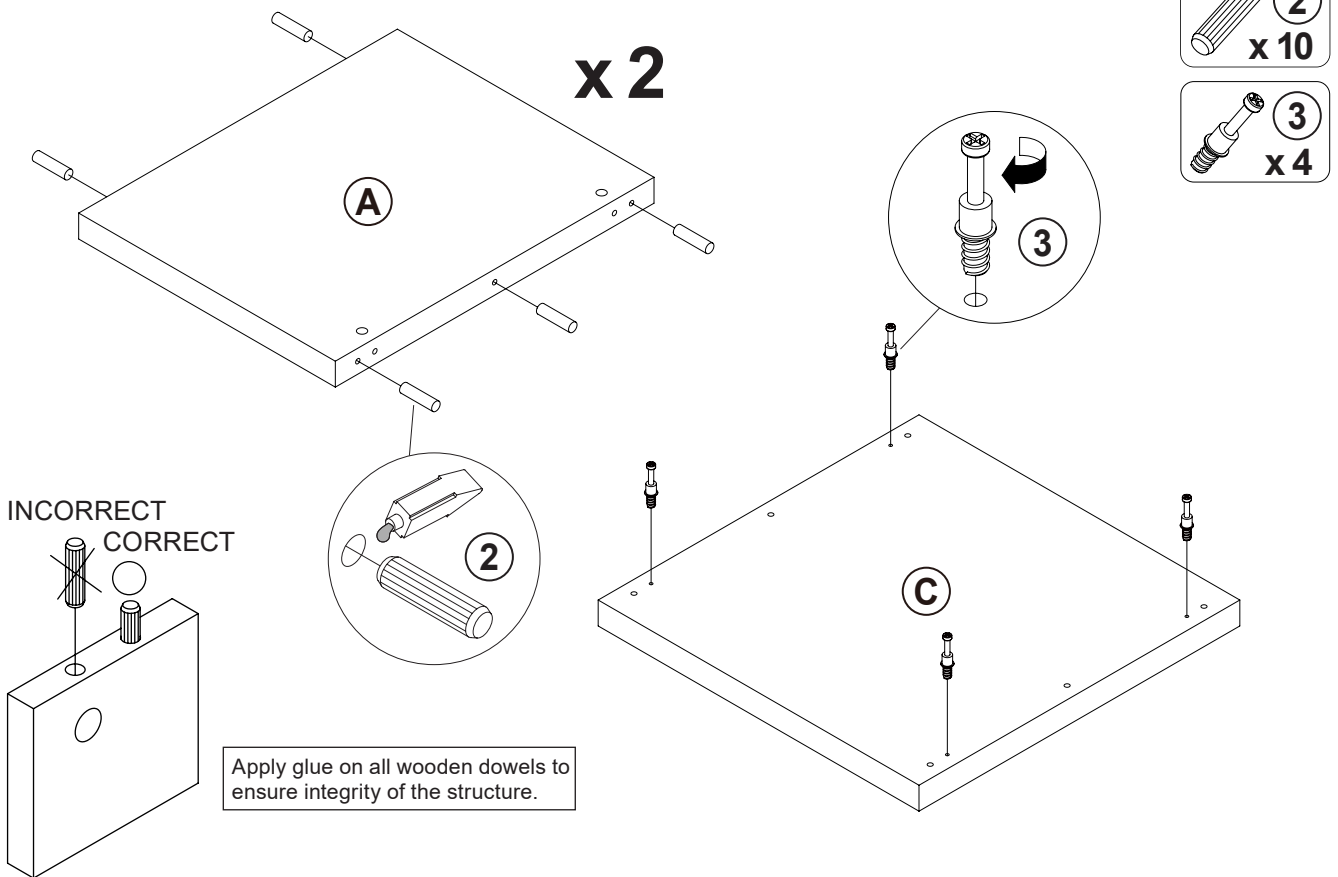

STEP 2

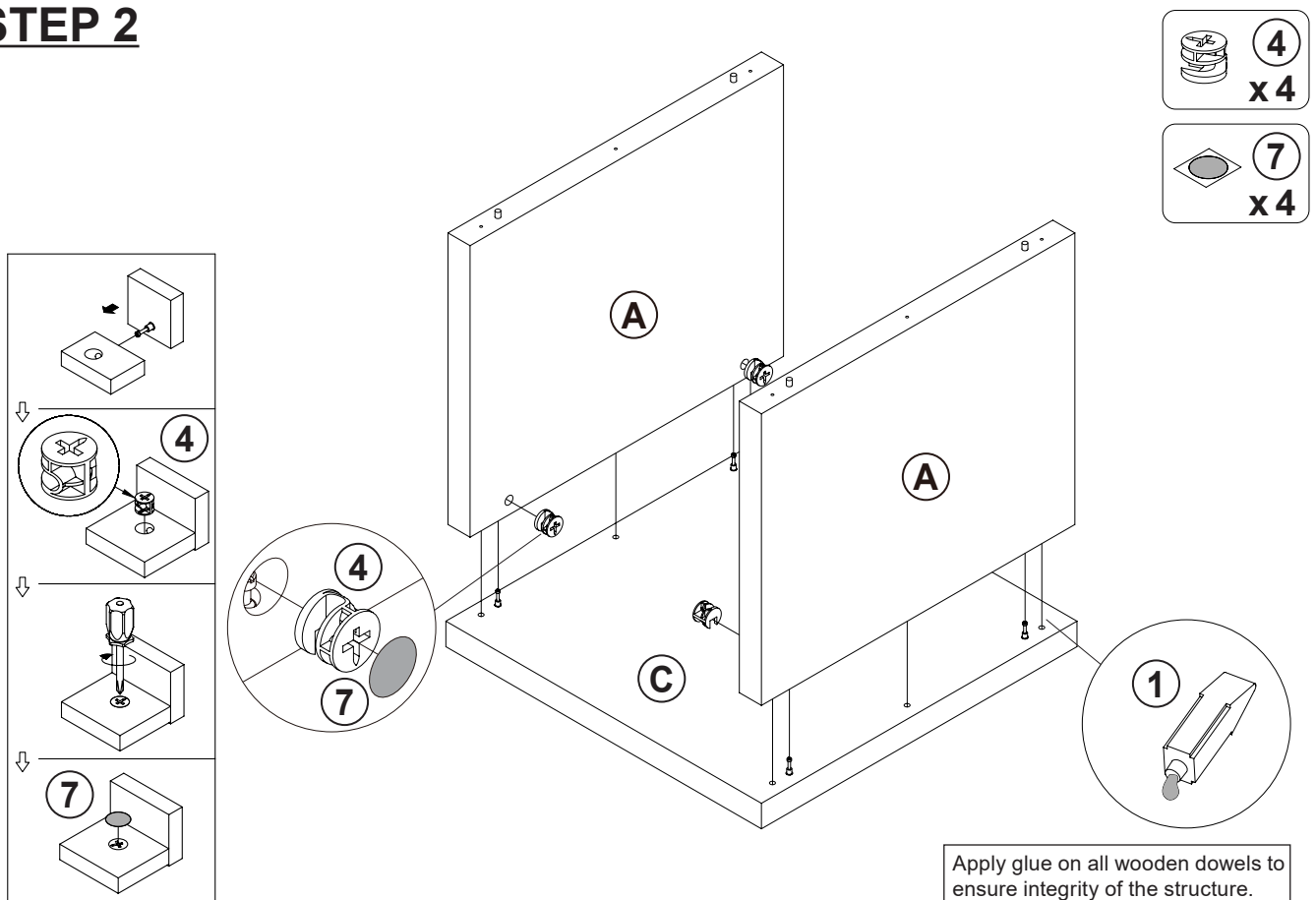

ITEM: 710517

STEP 3

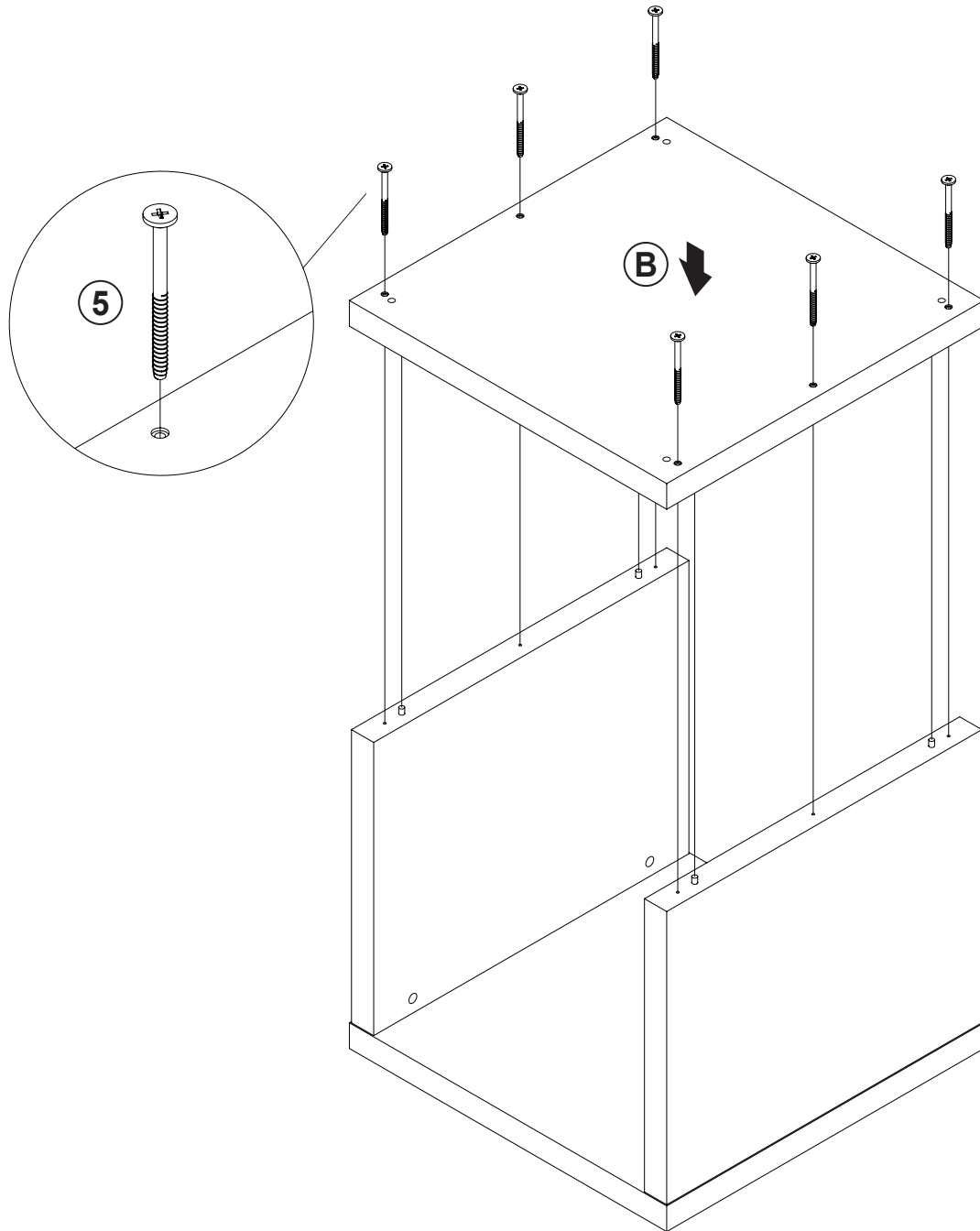
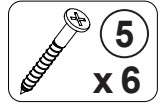

ITEM: 710517

COASTER
FINE FURNITURE

STEP 4

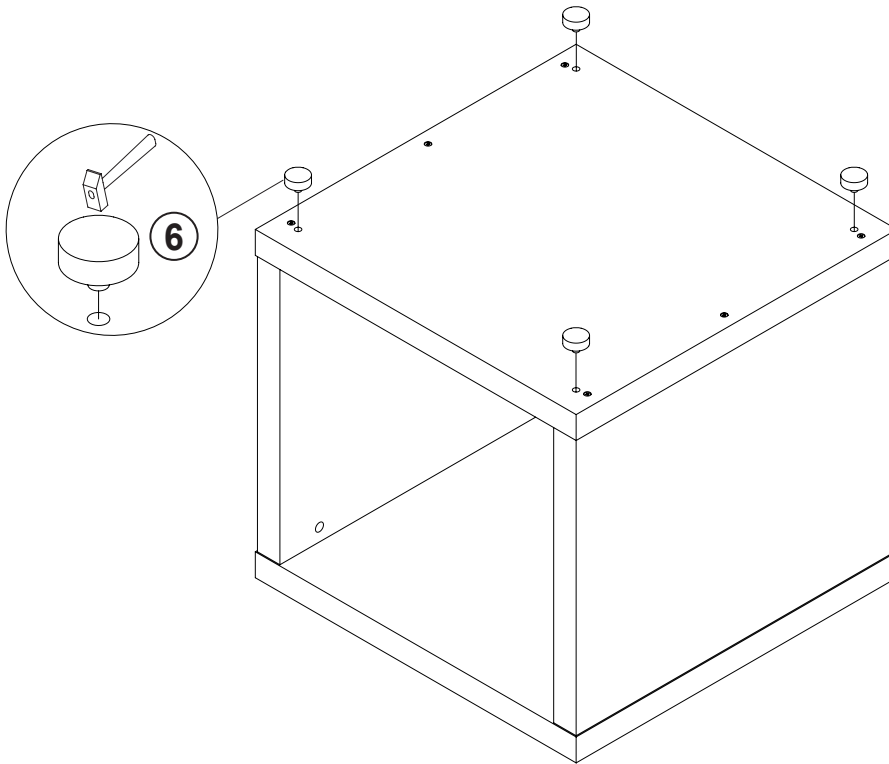
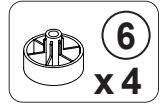

STEP 5

COMPLETE

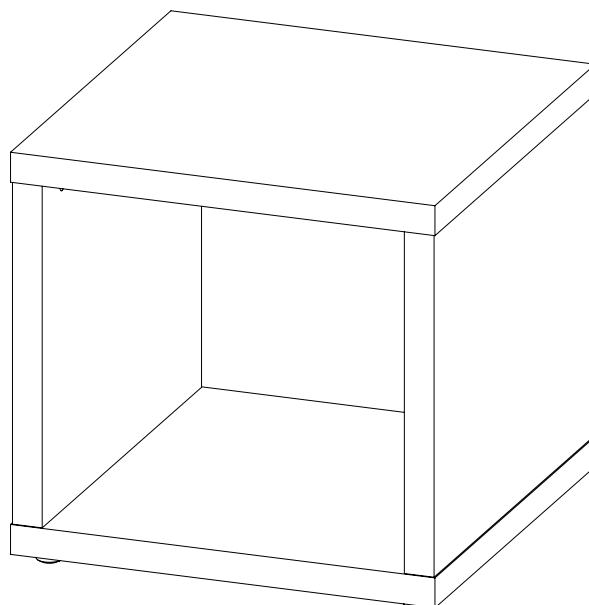

ITEM:710517

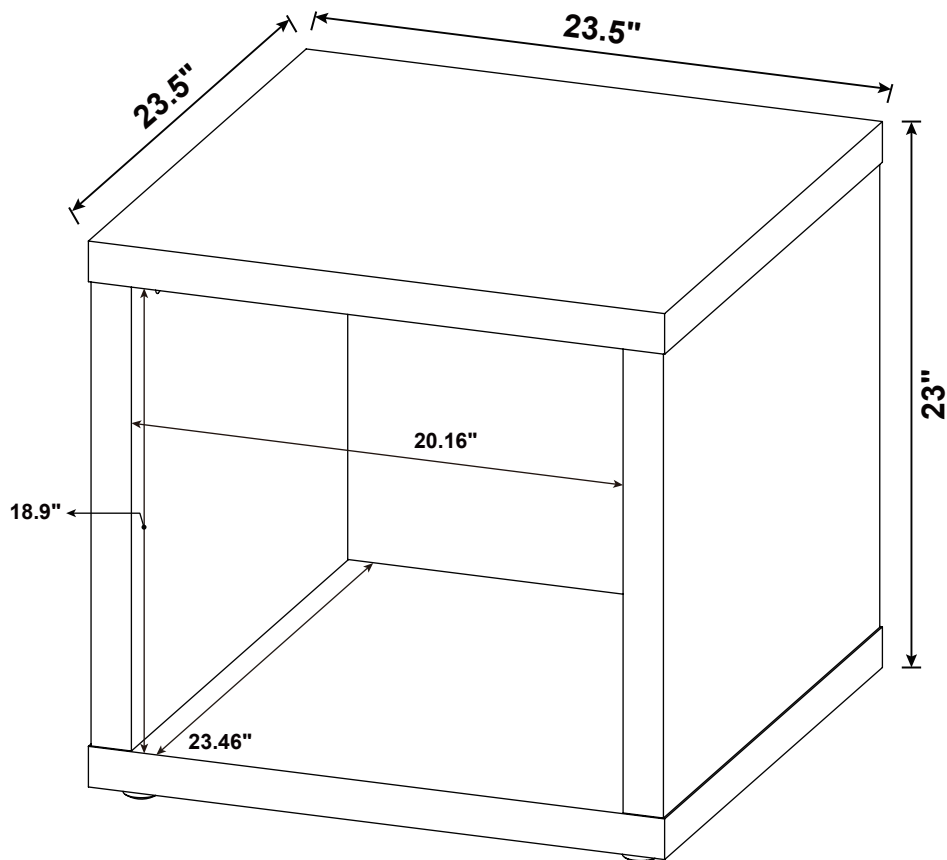

Note : Dimension tolerance $\pm 5\%$