

ASSEMBLY INSTRUCTIONS
COASTER FINE FURNITURE

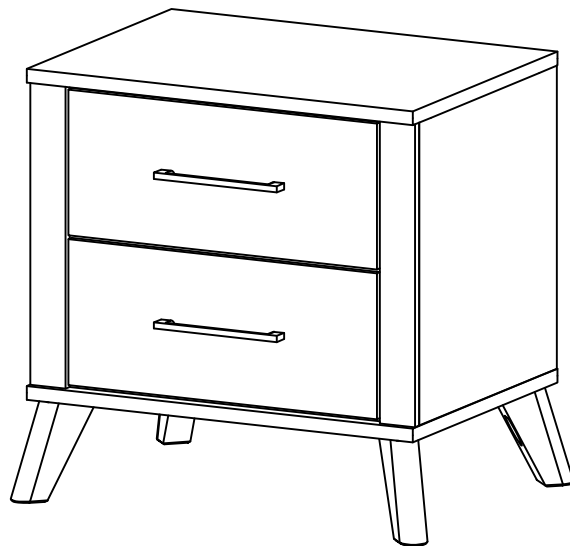

Fine Furniture for every stage of life

225002
Nightstand

ITEM: **225002**



ASSEMBLY INSTRUCTIONS

ASSEMBLY TIPS:

1. Remove hardware from box and sort by size.
2. Please check to see that all hardware and parts are present prior to start of assembly.
3. Please follow attached instructions in the same sequence as numbered to assure fast & easy assembly.



WARNING!

1. Don't attempt to repair or modify parts that are broken or defective. Please contact the store immediately.
2. This product is for home use only and not intended for commercial establishments.

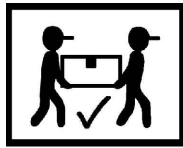

ASSEMBLY TIME

10 MINUTES

PARTS IDENTIFICATION

A NIGHTSTAND

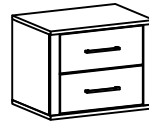

1PC

B LEG



4PCS

HARDWARE IDENTIFICATION

1 BOLT
(M6 x 60MM - RBW)



4PCS

2 LOCK WASHER
(1/4" x 13Ø - RBW)



4PCS

3 FLAT WASHER
(1/4" x 19Ø - RBW)



4PCS

4 WOOD DOWEL
(Ø8 x 30MM)

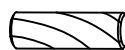

4PCS

5 ALLEN WRENCH
(M4 x 60MM - BLK)



1PC

ITEM: **225002**

ASSEMBLY INSTRUCTIONS



STEP 1

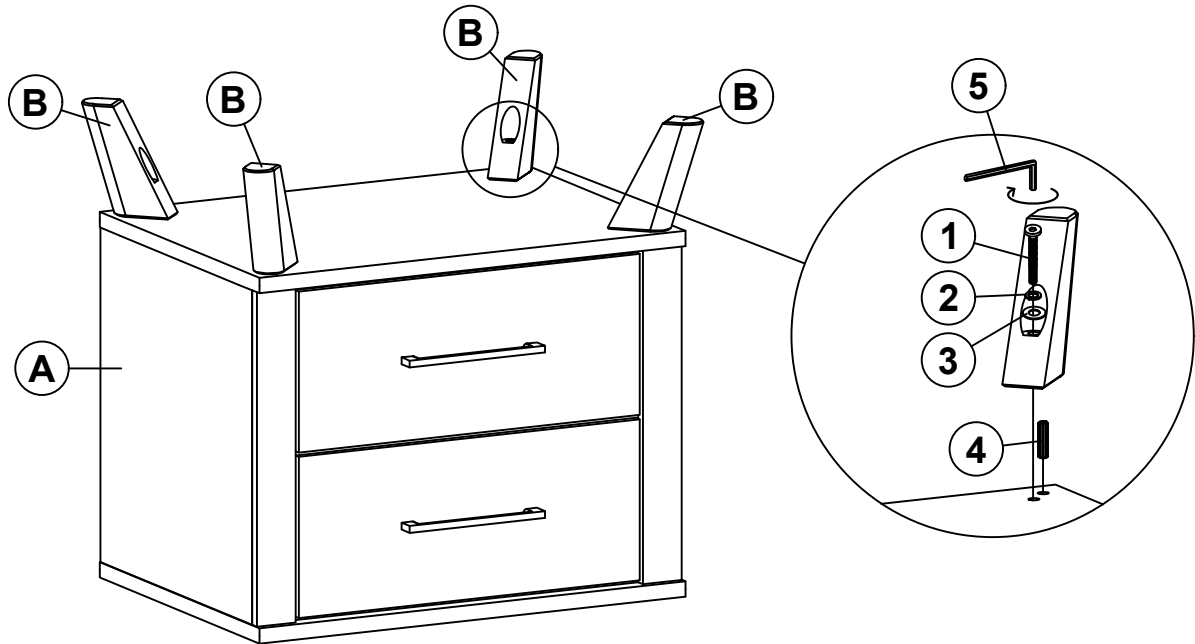

STEP 2 COMPLETE

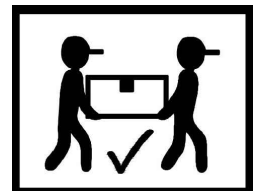
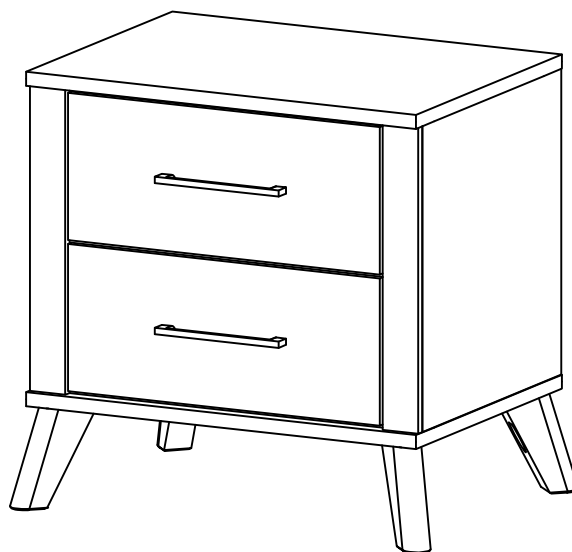

ITEM: **225002**



Inner Size of Drawer : 15.00"W X 12.25"D X 4.00"H X 0.50"T

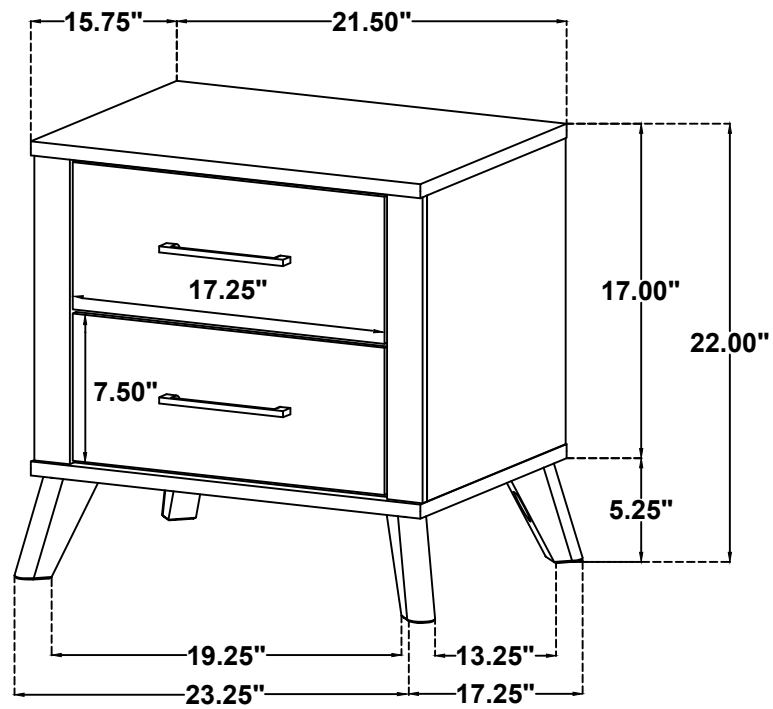

Note : Dimension tolerance $\pm 5\%$