



ASSEMBLY INSTRUCTIONS COASTER FINE FURNITURE



802018
OFFICE CHAIR

ITEM:802018



ASSEMBLY INSTRUCTIONS

ASSEMBLY TIPS:

1. Remove hardware from box and sort by size.
2. Please check to see that all hardware and parts are present prior to start of assembly.
3. Please follow attached instructions in the same sequence as numbered to assure fast & easy assembly.



WARNING!

1. Don't attempt to repair or modify parts that are broken or defective. Please contact the store immediately.
2. This product is for home use only and not intended for commercial establishments.

ASSEMBLY TIME

5 MINUTES

PARTS IDENTIFICATION

A		CASTOR	5PCS
B		BASE	1PC
C		GAS LIFT	1PC
D		SEAT	1PC
E		LEFT ARMREST	1PC
F		RIGHT ARMREST	1PC
G		BACKREST	1PC
H		ADJUSTING PLATE	1PC

HARDWARE IDENTIFICATION

NO	DESCRIPTION	FIGURE	QTY
1	BLOT (M8±20mm - BLK)		8PCS
2	BLOT (M6±35mm - BLK)		4PCS
3	FLAT WASHER (M6±18mm±1.2mm - BLK)		8PCS
4	CAP		4PCS
5	ALLEN WERNCH (M6 - BLK)		1PC

ITEM:802018

ASSEMBLY INSTRUCTIONS



STEP 1

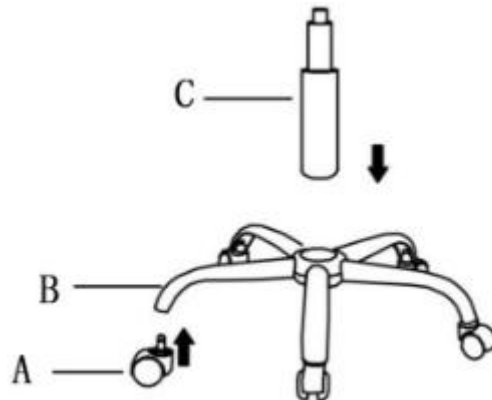

STEP 2

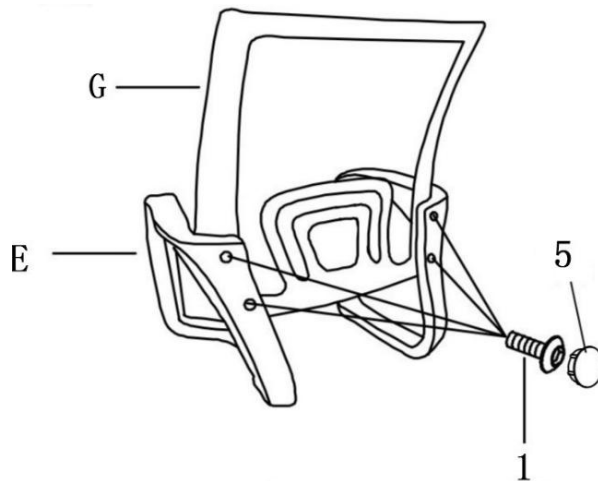

STEP 3

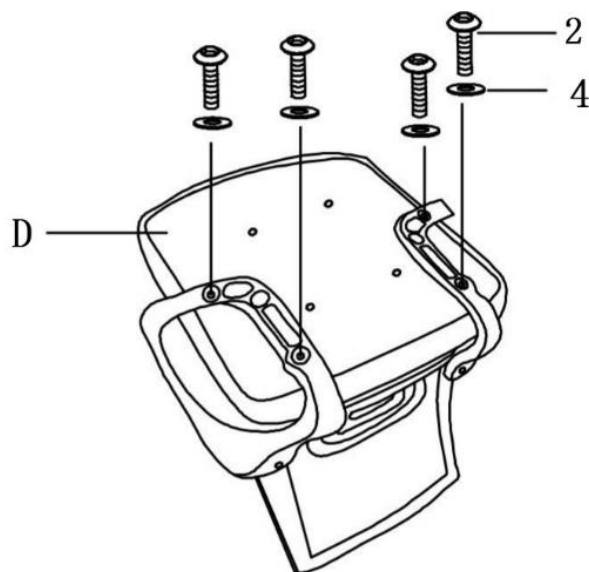

COASTERFURNITURE.COM

ITEM:802018

ASSEMBLY INSTRUCTIONS



STEP 4

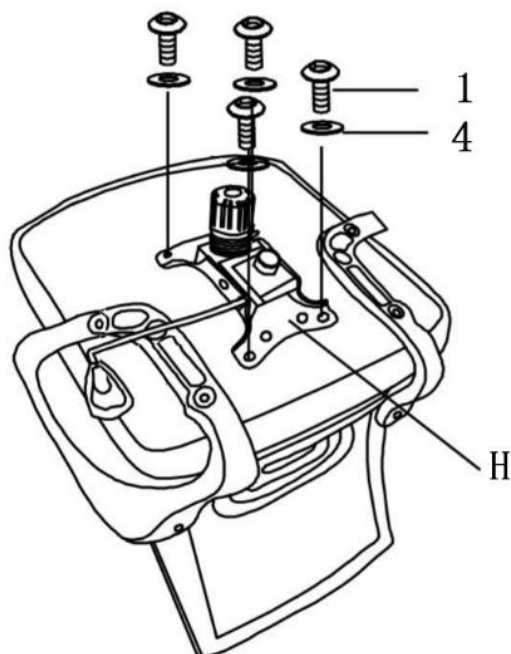

STEP 5



COASTERFURNITURE.COM

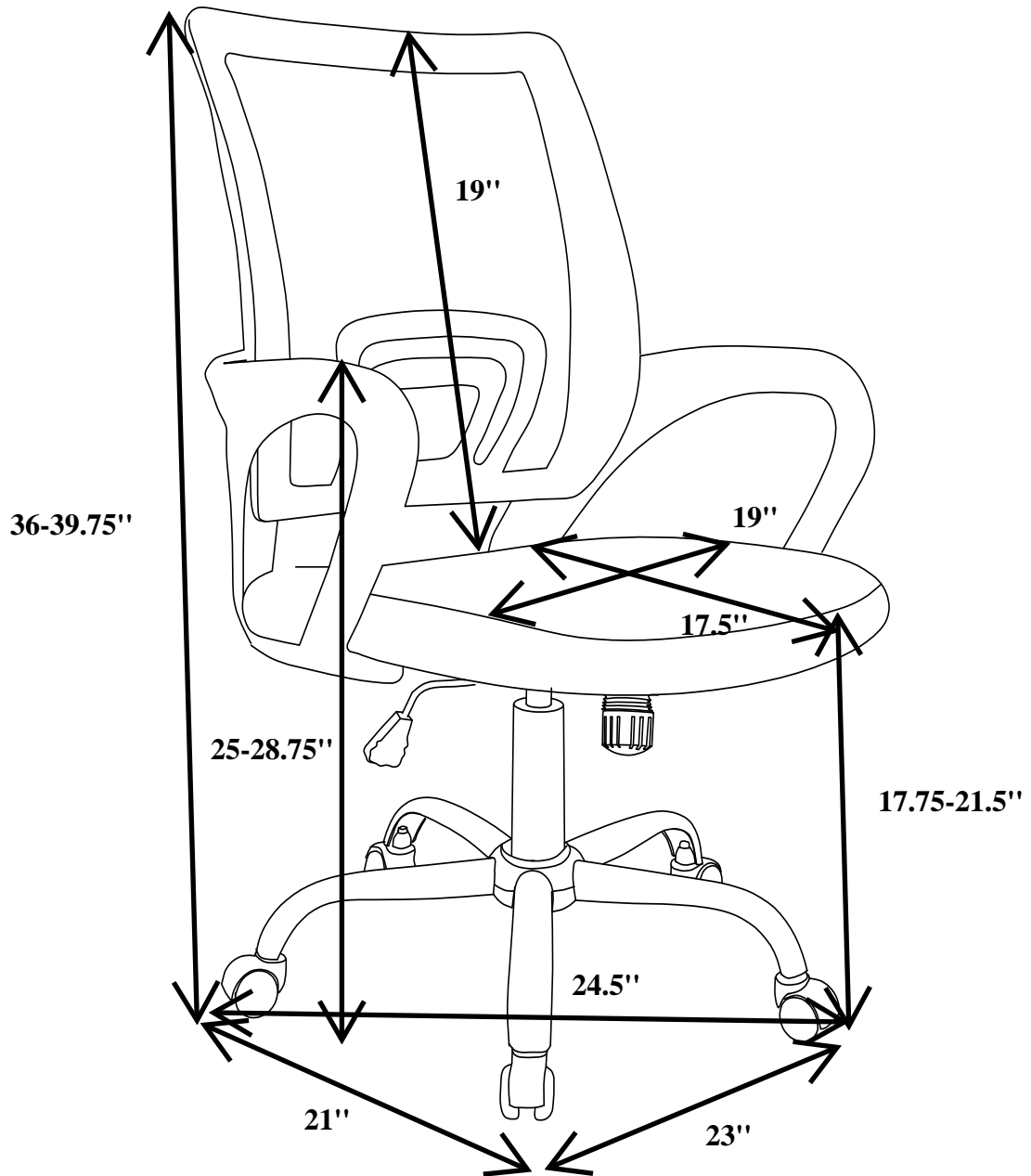

Note : Dimension tolerance ± 5