

*ASSEMBLY INSTRUCTIONS*  
*COASTER FINE FURNITURE*



*Fine Furniture for every stage of life*

**901199**  
**FLOOR LAMP**

REVISION 0:05/07/2019  
REVISION 1:12/01/2022  
REVISION 2:04/26/2023  
REVISION 3:07/21/2023  
REVISION 4:06/06/2024

# ITEM :901199

## Assembly Instructions



### ASSEMBLY TIPS:









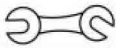

1. Remove hardware from box and sort by size.
2. Please check to see that all hardware and parts are present prior to start of assembly.
3. Please follow attached instructions in the same sequence as numbered to assure fast & easy assembly.

### Warning!

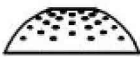

1. Don't attempt to repair or modify parts that are broken or defective. Please contact the store immediately.
2. This product is for home use only and not intended for commercial establishments.

## PARTS IDENTIFICATION

NO	DESCRIPTION	FIGURE	Q,TY	HARDWARE PACKAGE			
				NO	DESCRIPTION	FIGURE	Q,TY
A	LAMP BODY ARM		1 PC	1	WRENCH		1 PC
B	LAMP BODY TUBE		1 PC	2	FLAT WASHER		1 PC
C	BASE		1 PC	3	SPRING WASHER		1 PC
D	BOTTOM SHADE		1 PC	4	NUT		1 PC
E	TOP SHADE		1 PC	5	HOLLOW SCREW		1 PC
F	LIGHT BULB		1 PC	6	SATIN NICKEL PLATE		1 PC

# ITEM :901199

## Assembly Instructions



### STEP1

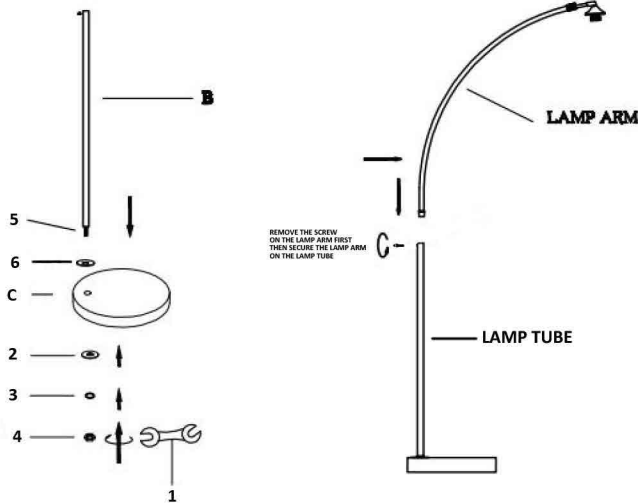

### STEP2

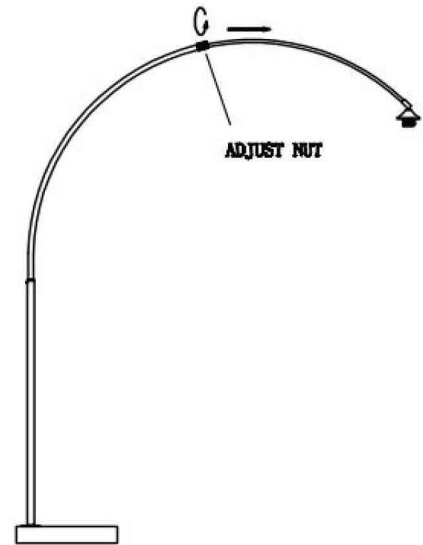

### STEP3

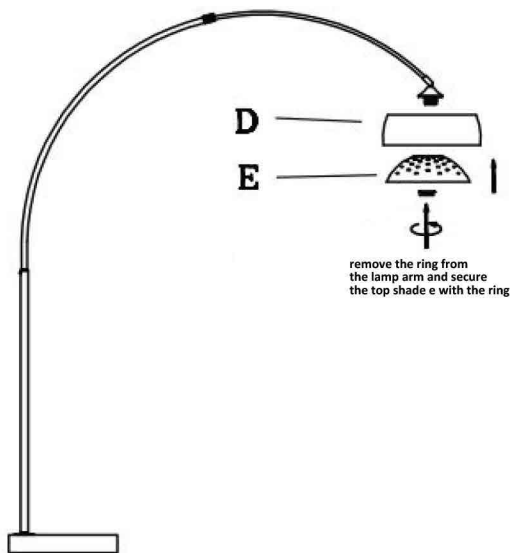

### STEP4

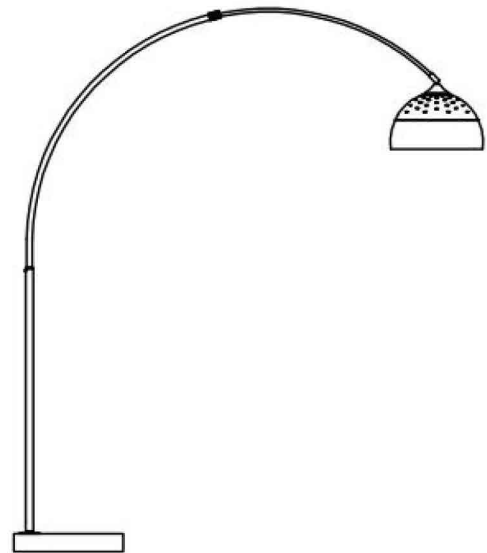

As a safety feature, and to reduce the risk of electric shock, this portable lamp includes a polarized plug (one blade is wider than the other). The plug will fit into a polarized outlet in a single direction only. If the plug does not fit fully in the outlet, reverse the plug and try again.

If it still does not fit, contact a qualified electrician. DO NOT use with an extension cord unless, can be fully inserted. DO NOT alter the plug.

**FLOOR LAMP:TYPE A LED BULB 9W**

ITEM :901199

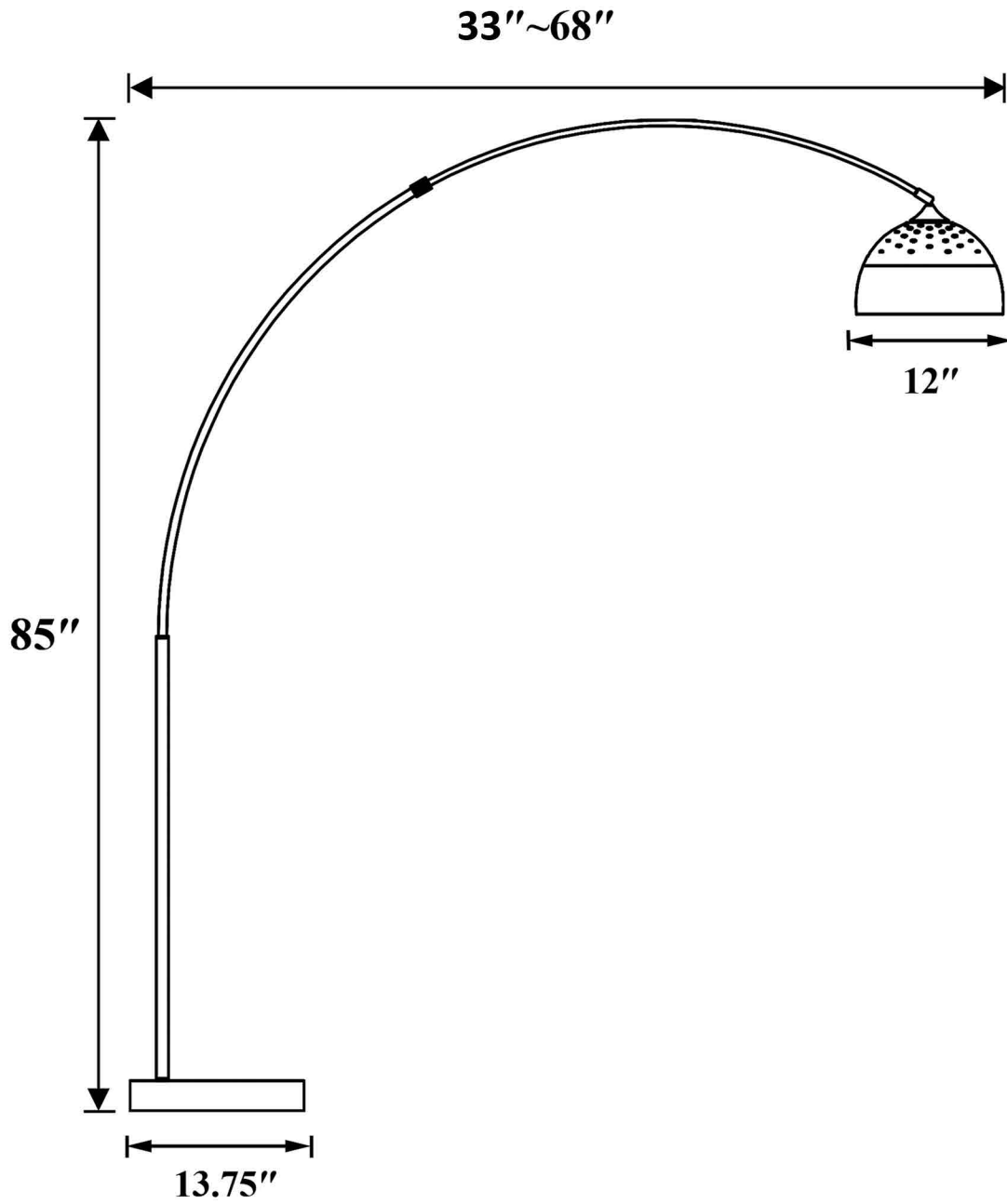

Note : Dimension tolerance  $\pm 5\%$