

ASSEMBLY INSTRUCTIONS
COASTER FINE FURNITURE

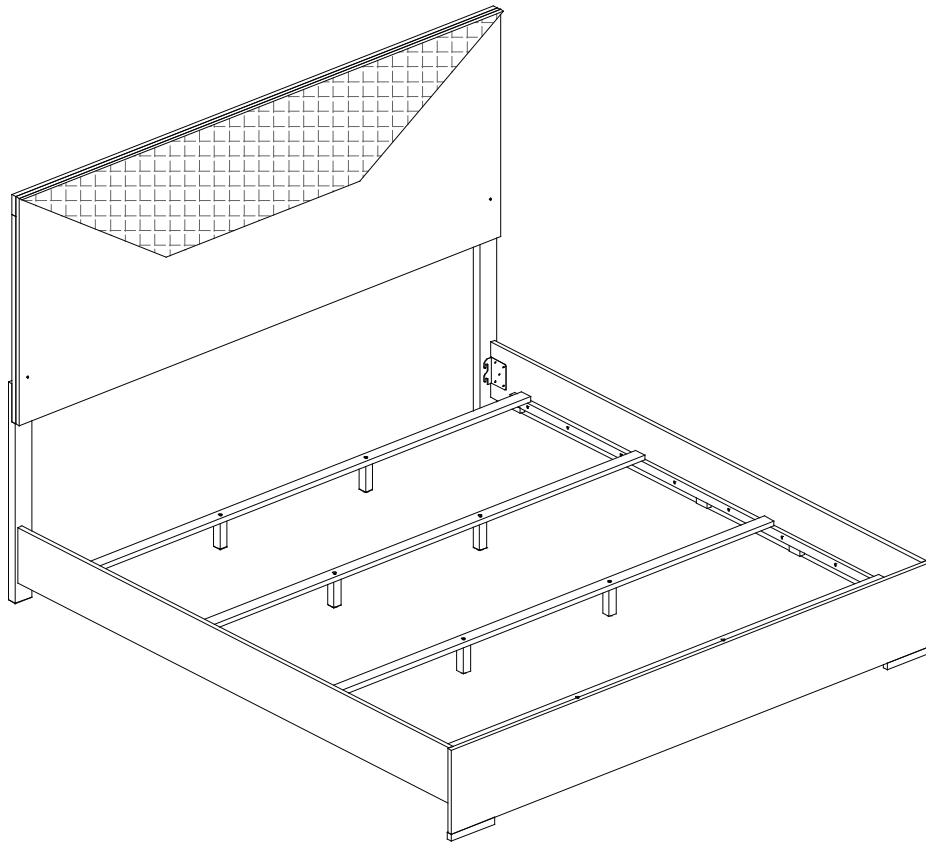

Fine Furniture for every stage of life

224971KE(B1&B2)
Eastern King Bed

ITEM: 224971KE(B1&B2)



ASSEMBLY INSTRUCTIONS

ASSEMBLY TIPS:

1. Remove hardware from box and sort by size.
2. Please check to see that all hardware and parts are present prior to start of assembly.
3. Please follow attached instructions in the same sequence as numbered to assure fast & easy assembly.



WARNING!

1. Don't attempt to repair or modify parts that are broken or defective. Please contact the store immediately.
2. This product is for home use only and not intended for commercial establishments.



ASSEMBLY TIME

25 MINUTES

PARTS IDENTIFICATION

B1 (BOX 1)

A HEADBOARD PANEL  1PC

B LEFT HEADBOARD LEG (WITH "L" LABEL)  1PC

C RIGHT HEADBOARD LEG (WITH "R" LABEL)  1PC

D FOOTBOARD  1PC

B2 (BOX 2)

H BED RAIL  2PCS

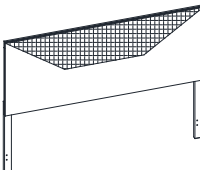
HB 224971KE (B1) FROM BOX 1 HEADBOARD COMPLETE  1PC

E BED SLAT  4PCS

F BED SLAT SUPPORT WITH LEVELER  8PCS

G ADAPTER  1PC

D 224971KE (B1) FROM BOX 1 FOOTBOARD  1PC

ITEM: 224971KE(B1&B2)



ASSEMBLY INSTRUCTIONS

ASSEMBLY TIPS:

1. Remove hardware from box and sort by size.
2. Please check to see that all hardware and parts are present prior to start of assembly.
3. Please follow attached instructions in the same sequence as numbered to assure fast & easy assembly.









WARNING!

1. Don't attempt to repair or modify parts that are broken or defective. Please contact the store immediately.
2. This product is for home use only and not intended for commercial establishments.

HARDWARE IDENTIFICATION

Z-B1 (BOX 1) - HARDWARE PACK IS LOCATED IN 224971KE (B1)

1	SMALL ALLEN WRENCH (M4 x 65MM - BLK)		1PC	4	BOLT (M6 x 30mm - RBW)		6PCS
2	BIG ALLEN WRENCH (M5 x 65MM - BLK)		1PC	5	LOCK WASHER (1/4" x 12ø - RBW)		6 PCS
3	FLAT HEAD SCREW (M4 x 32MM - RBW)		8PCS	6	FLAT WASHER (1/4" x 19ø - RBW)		6 PCS

NOTE:

Phillips head screw driver is required in the assembly process; however, manufacturer does not provided this item.

ITEM: 224971KE(B1&B2)

ASSEMBLY INSTRUCTIONS

STEP 1

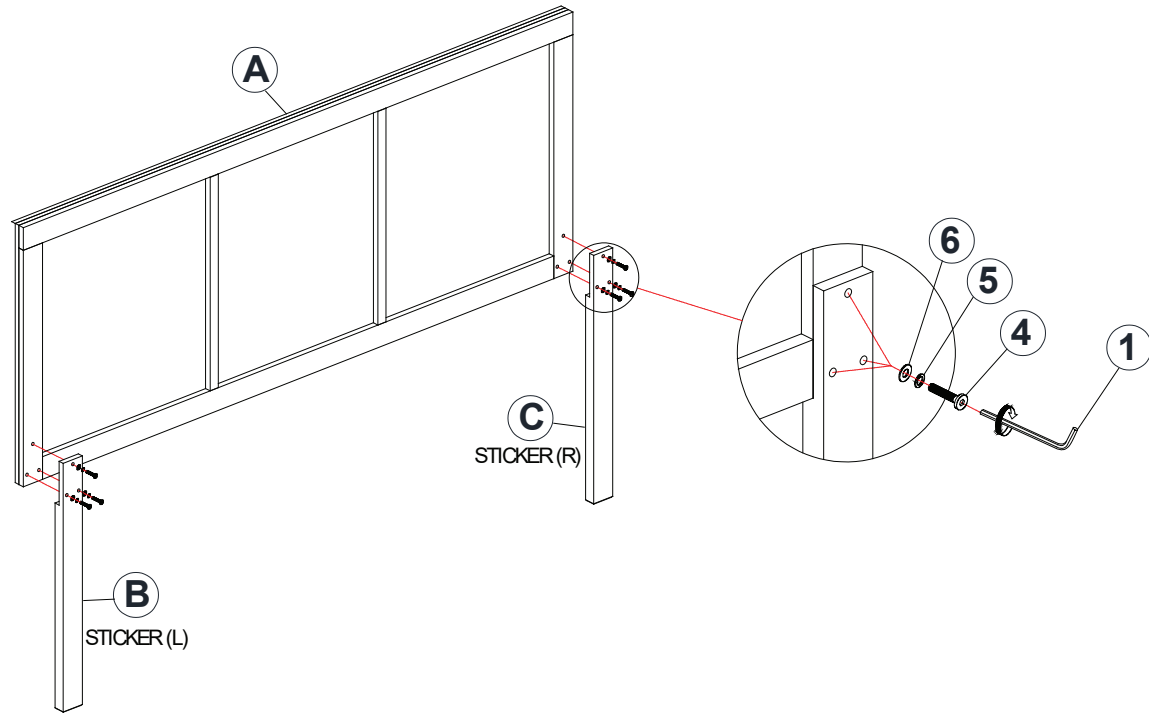

**** BACK VIEW**

STEP 2

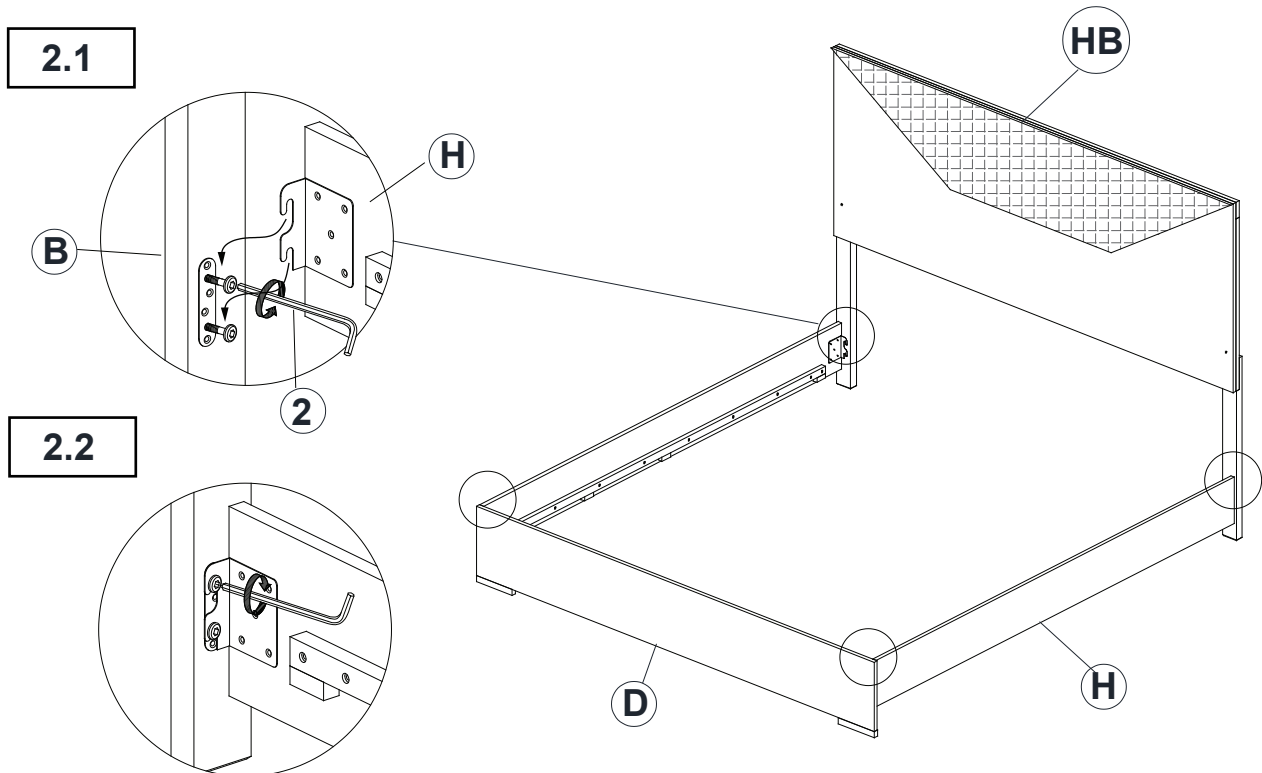

ITEM: 224971KE(B1&B2)



ASSEMBLY INSTRUCTIONS

STEP 3

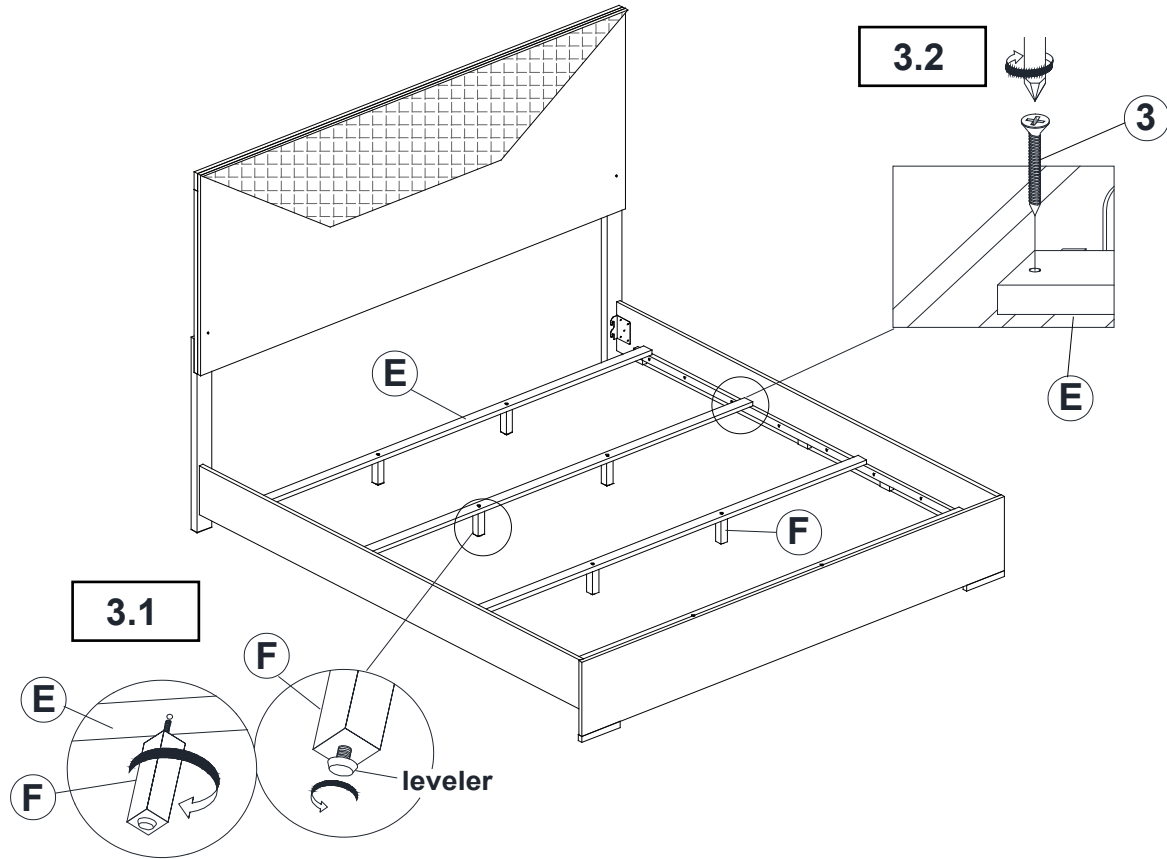

STEP 4 COMPLETE

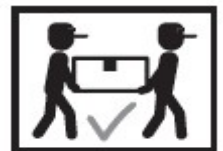
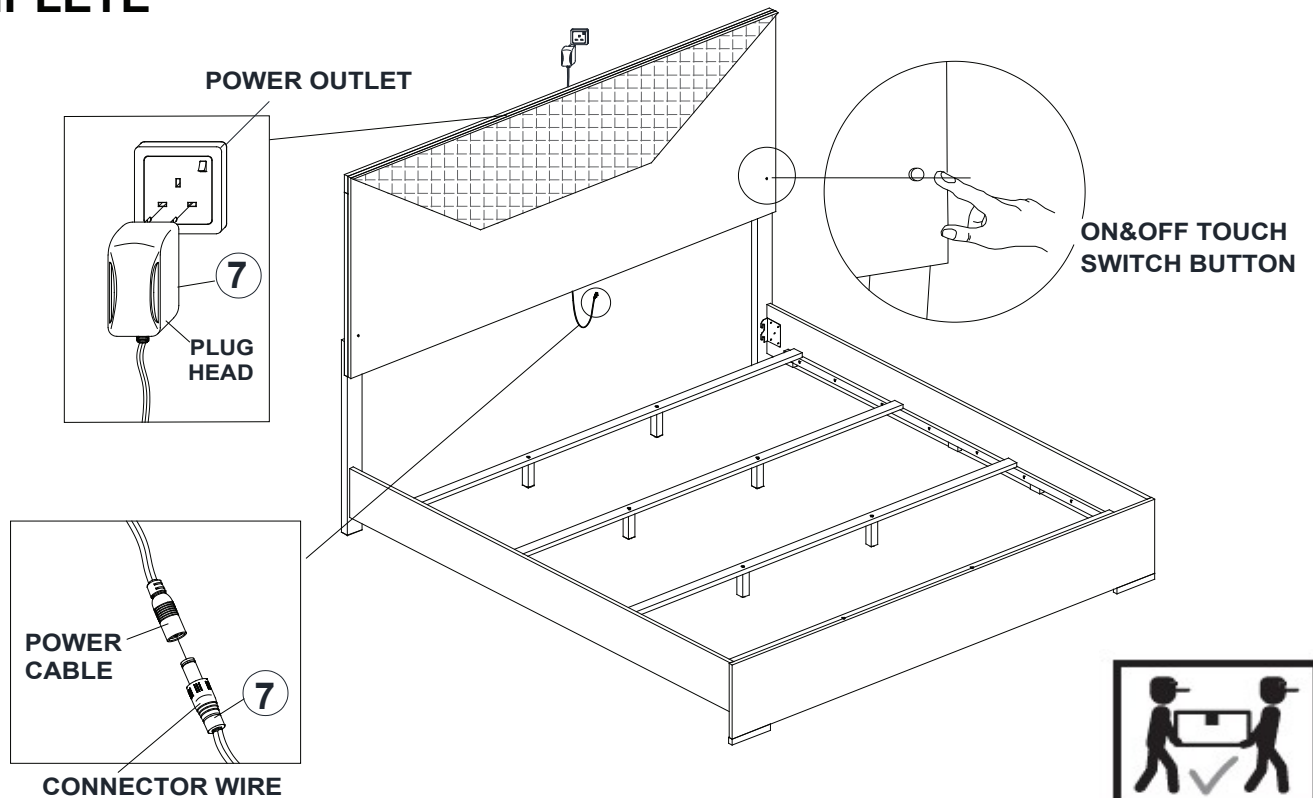

ITEM: **224971KE(B1&B2)**



Inner Size : 77.00"W X 80.50"D

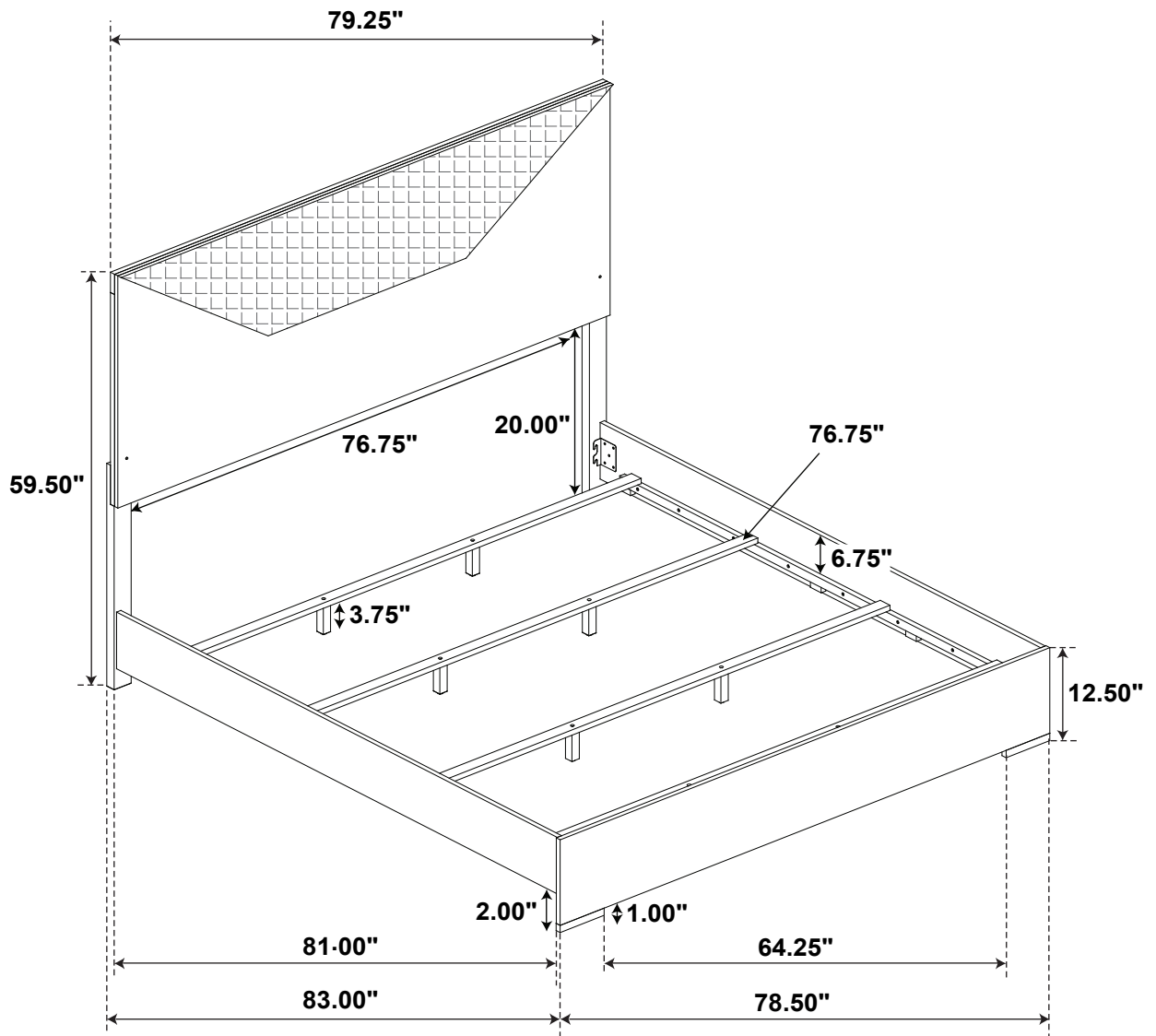

Note : Dimension tolerance $\pm 5\%$