

ASSEMBLY INSTRUCTIONS COASTER FINE FURNITURE

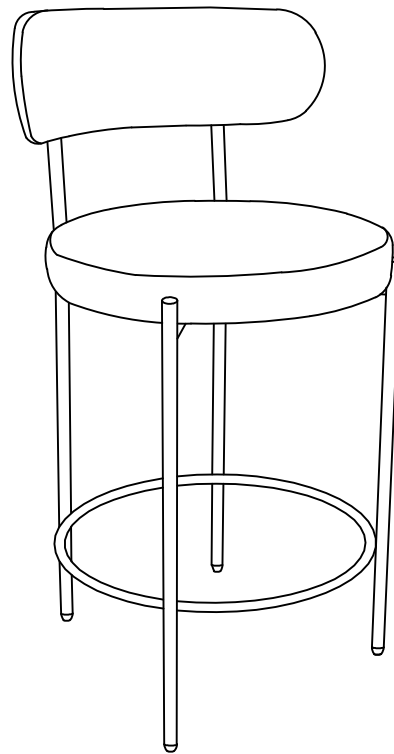

Fine Furniture for every stage of life

108198
COUNTER STOOL

ITEM: **108198**



ASSEMBLY INSTRUCTIONS

ASSEMBLY TIPS:

1. Remove hardware from box and sort by size.
2. Please check to see that all hardware and parts are present prior to start of assembly.
3. Please follow attached instructions in the same sequence as numbered to assure fast & easy assembly.



WARNING !

1. Don't attempt to repair or modify parts that are broken or defective. Please contact the store immediately.
2. This product is for home use only and not intended for commercial establishments.

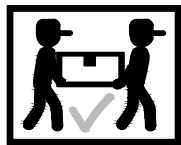



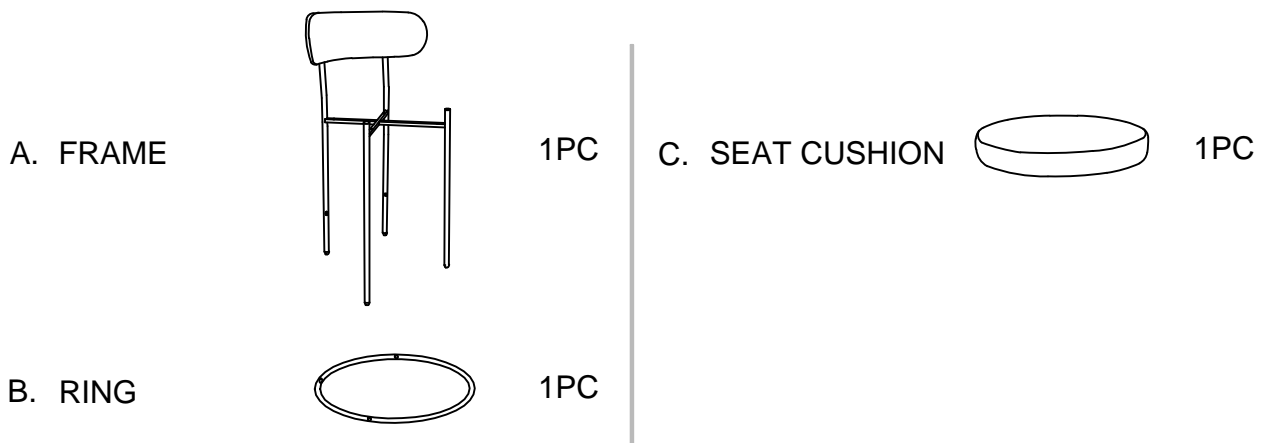

ASSEMBLY TIME 20 MINUTES

PARTS IDENTIFICATION



Z HARDWARE PACKAGE

- | | | | | | |
|------------------------------------|---|------|----------------------------------|---|------|
| 1. ALLEN WRENCH
(M6*57mm-BLACK) |  | 1PC | 2. ALLEN BOLT
(M6*60mm-BLACK) |  | 4PCS |
| 3. ALLEN BOLT
(M6*25mm-BLACK) |  | 4PCS | 4. LOCK WASHER
(M6-BLACK) |  | 4PCS |
| 5. FLAT WASHER
(M6*Ø6mm-BLACK) |  | 4PCS | | | |

NOTE:QUANTITIES SHOWN ARE FOR ONE CHAIRS

ITEM: **108198**
ASSEMBLY INSTRUCTIONS



STEP 1

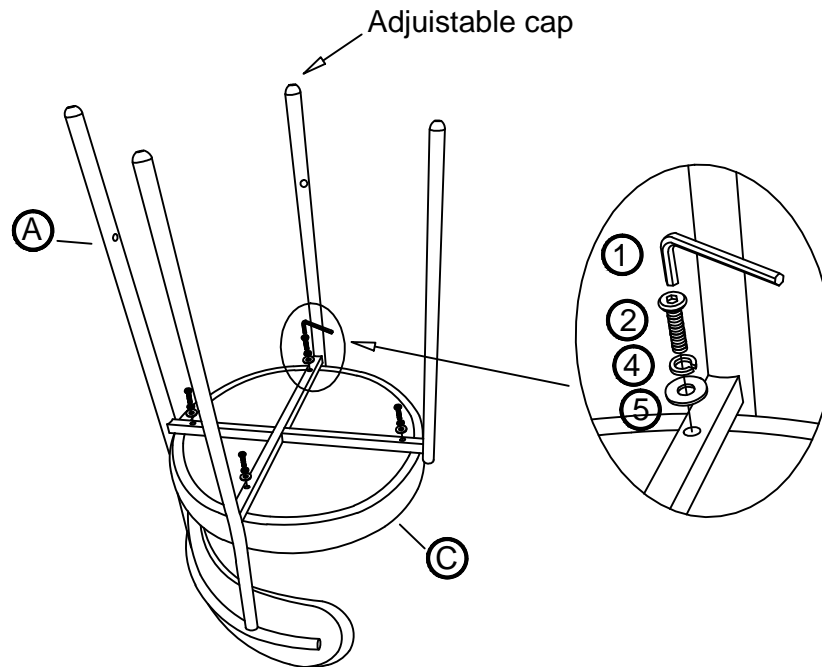

STEP 2

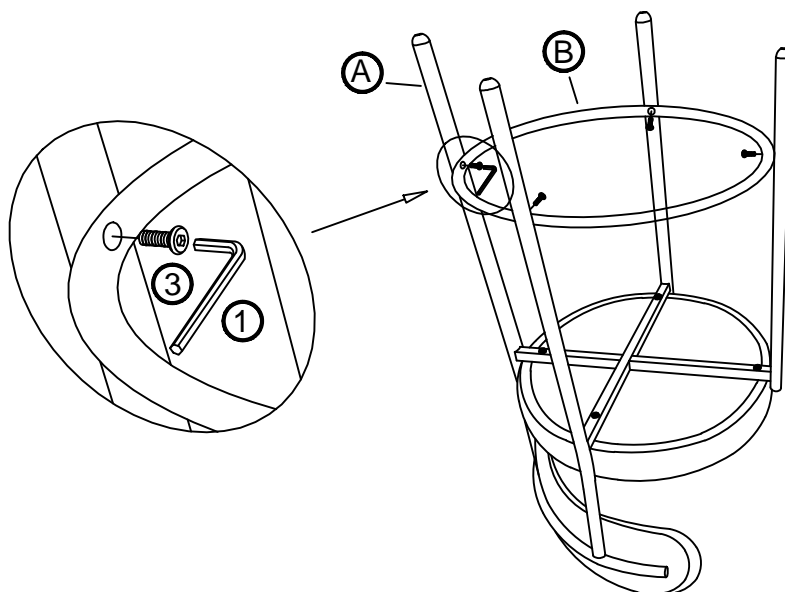

ITEM: **108198**
ASSEMBLY INSTRUCTIONS



STEP 3
COMPLETE

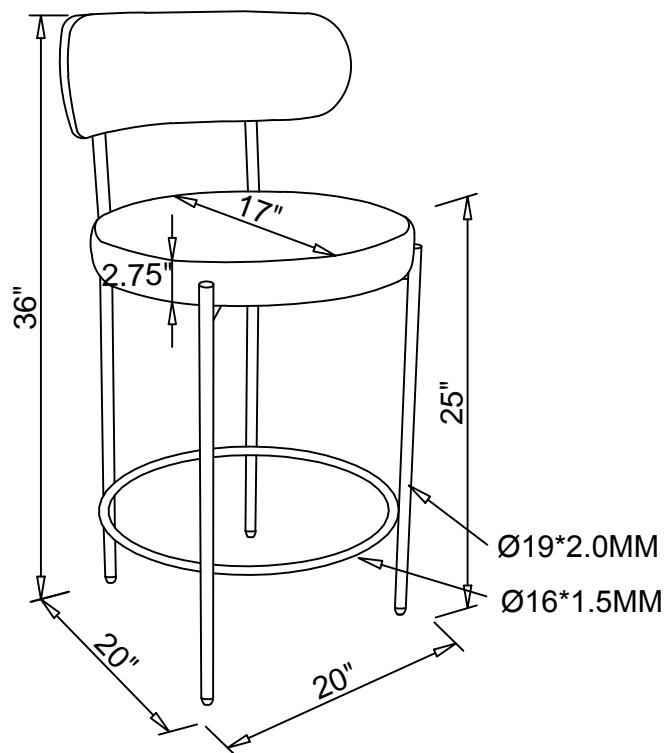

Note: Dimension tolerance $\pm 5\%$