

ASSEMBLY INSTRUCTIONS
COASTER FINE FURNITURE

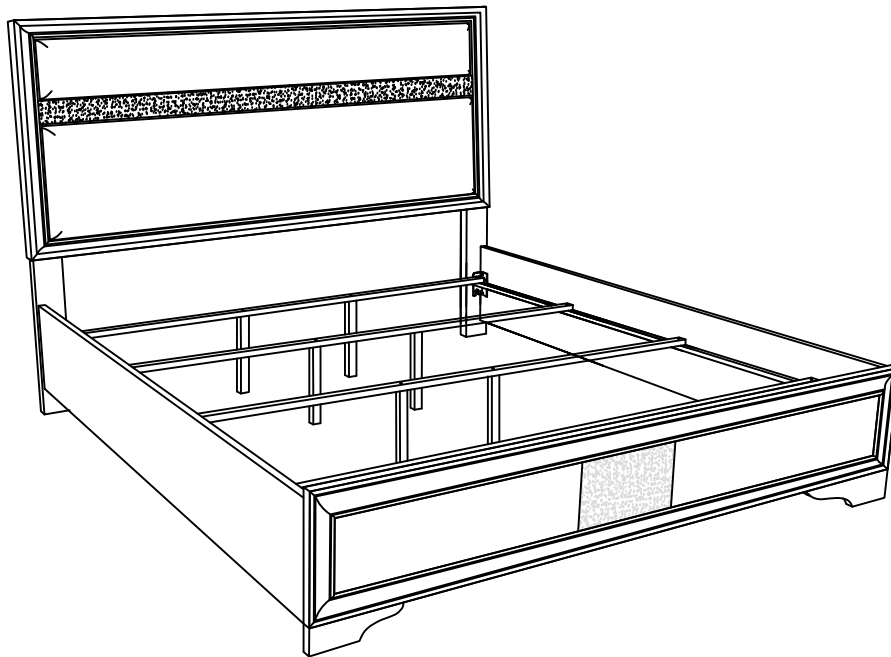

Fine Furniture for every stage of life

206360KE(B1&B2)
Eastern King Bed

ITEM: 206360KE(B1&B2)



ASSEMBLY INSTRUCTIONS

ASSEMBLY TIPS:

1. Remove hardware from box and sort by size.
2. Please check to see that all hardware and parts are present prior to start of assembly.
3. Please follow attached instructions in the same sequence as numbered to assure fast & easy assembly.



WARNING!

1. Don't attempt to repair or modify parts that are broken or defective. Please contact the store immediately.
2. This product is for home use only and not intended for commercial establishments.







ASSEMBLY TIME

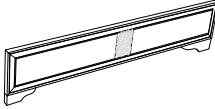

20 MINUTES

PARTS IDENTIFICATION

B1 (BOX 1)

A	HEADBOARD PANEL		1PC
B	FOOTBOARD		1PC
C	LEFT HEADBOARD LEG		1PC
D	RIGHT HEADBOARD LEG		1PC
E	BED SLAT		4PCS
F	BED SLAT SUPPORT WITH LEVELER		8PCS

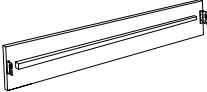
B2 (BOX 2)

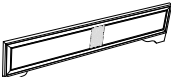
G	BED RAIL		2PCS
HB	206360KE(B1) FROM BOX 1 HEADBOARD COMPLETE		1PC
B	206360KE(B1) FROM BOX 1 FOOTBOARD		1PC

ITEM:206360KE(B1&B2)



ASSEMBLY INSTRUCTIONS

ASSEMBLY TIPS:

1. Remove hardware from box and sort by size.
2. Please check to see that all hardware and parts are present prior to start of assembly.
3. Please follow attached instructions in the same sequence as numbered to assure fast & easy assembly.









WARNING!

1. Don't attempt to repair or modify parts that are broken or defective. Please contact the store immediately.
2. This product is for home use only and not intended for commercial establishments.

HARDWARE IDENTIFICATION

Z-B1(BOX 1) - HARDWARE PACK IS LOCATED IN 206360KE(B1)

1	BOLT (M6 x 30mm - BLK)		6PCS
2	LOCK WASHER (1/4" - BLK)		6PCS
3	FLAT WASHER (1/4" x 13mm - BLK)		6PCS
4	SMALL ALLEN WRENCH (M4 x 65mm - BLK)		1PC
5	BIG ALLEN WRENCH (M5 x 65mm - BLK)		1PC
6	FLAT HEAD SCREW (M4 x 32mm - RBW)		8PCS

NOTE:

Phillips head screw driver is required in the assembly process; however, manufacturer does not provide this item.

ITEM: 206360KE(B1&B2)



ASSEMBLY INSTRUCTIONS

STEP 1

Note : Please put item on soft surface.

Please take note of the marking sticker (L&R) on the leg.

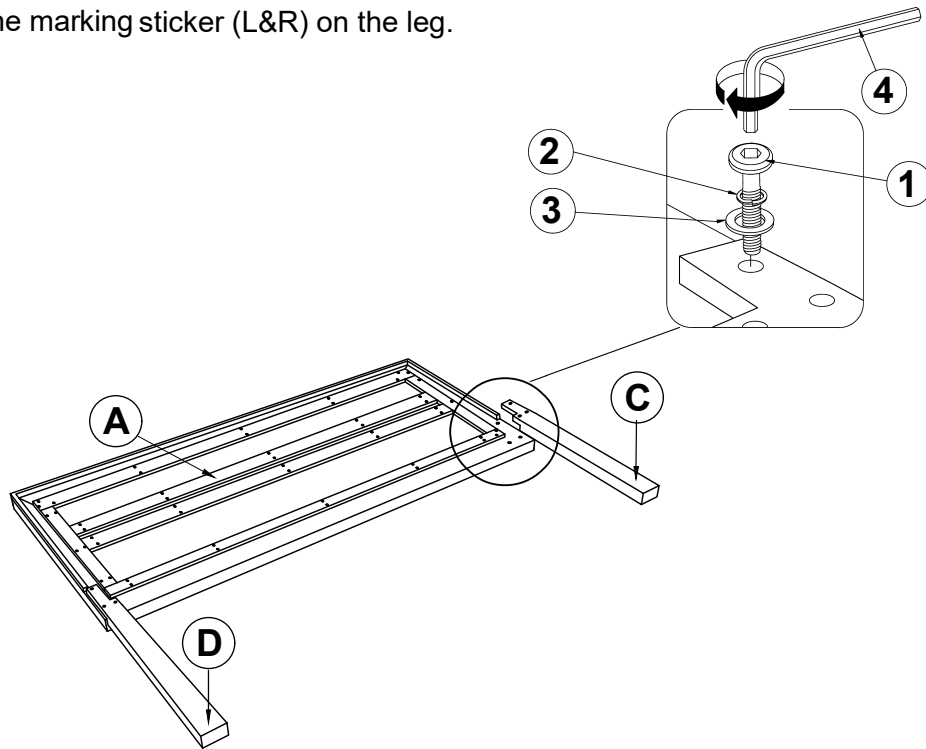

****BACK VIEW****

STEP 2

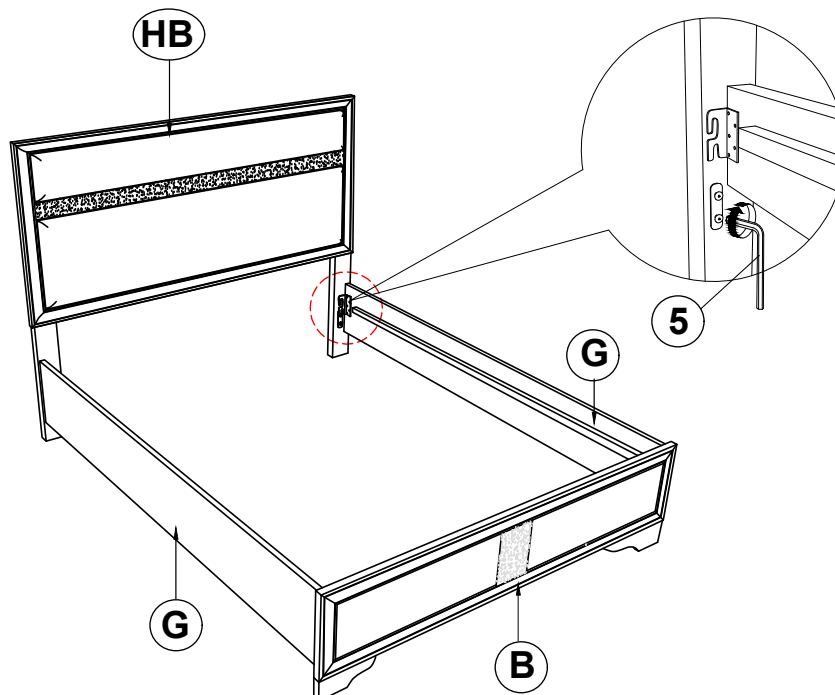

ITEM: **206360KE(B1&B2)**



ASSEMBLY INSTRUCTIONS

STEP 3

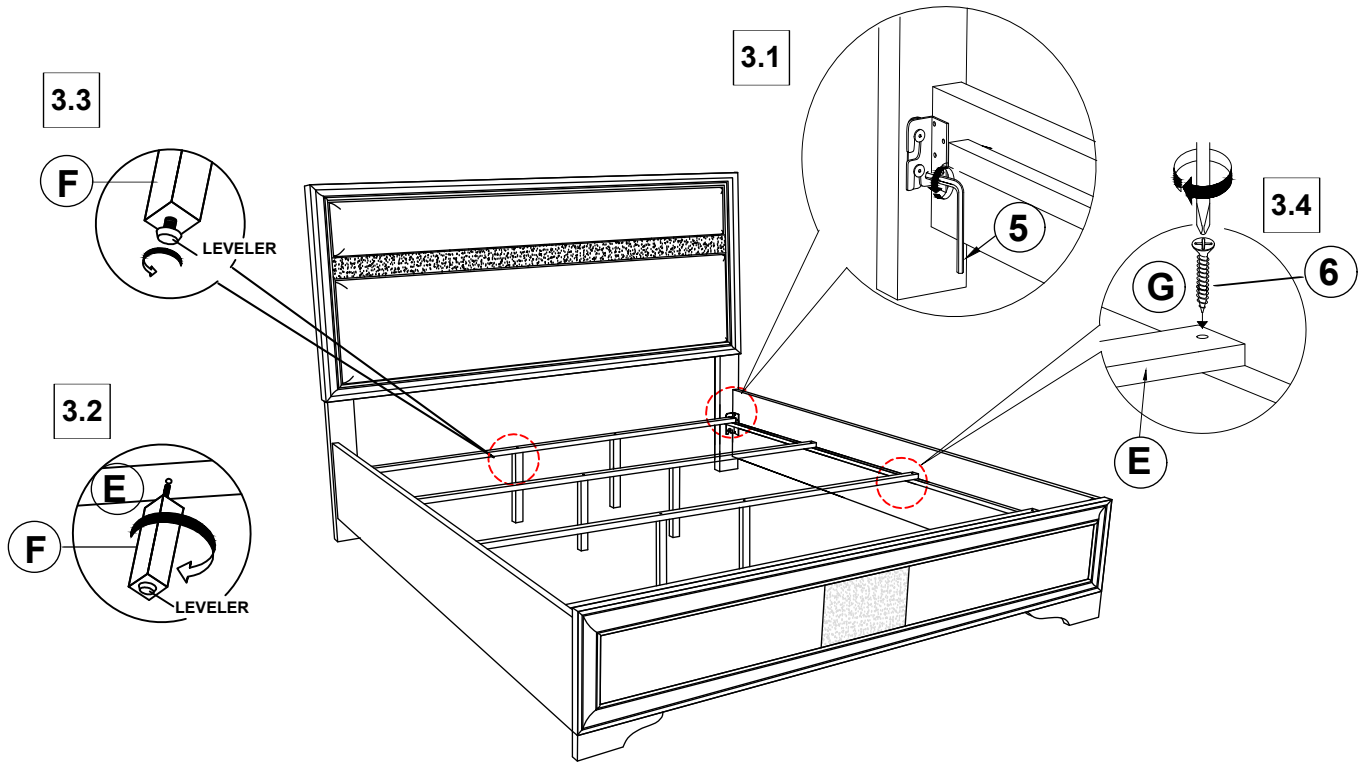

STEP 4 **COMPLETE**

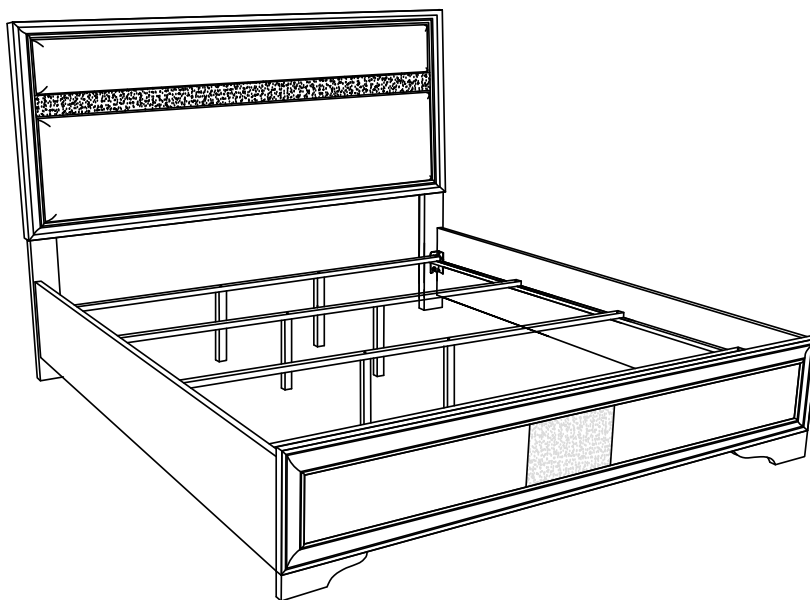

ITEM: 206360KE(B1&B2)



Inner Size : 76.75"W x 81.00"D

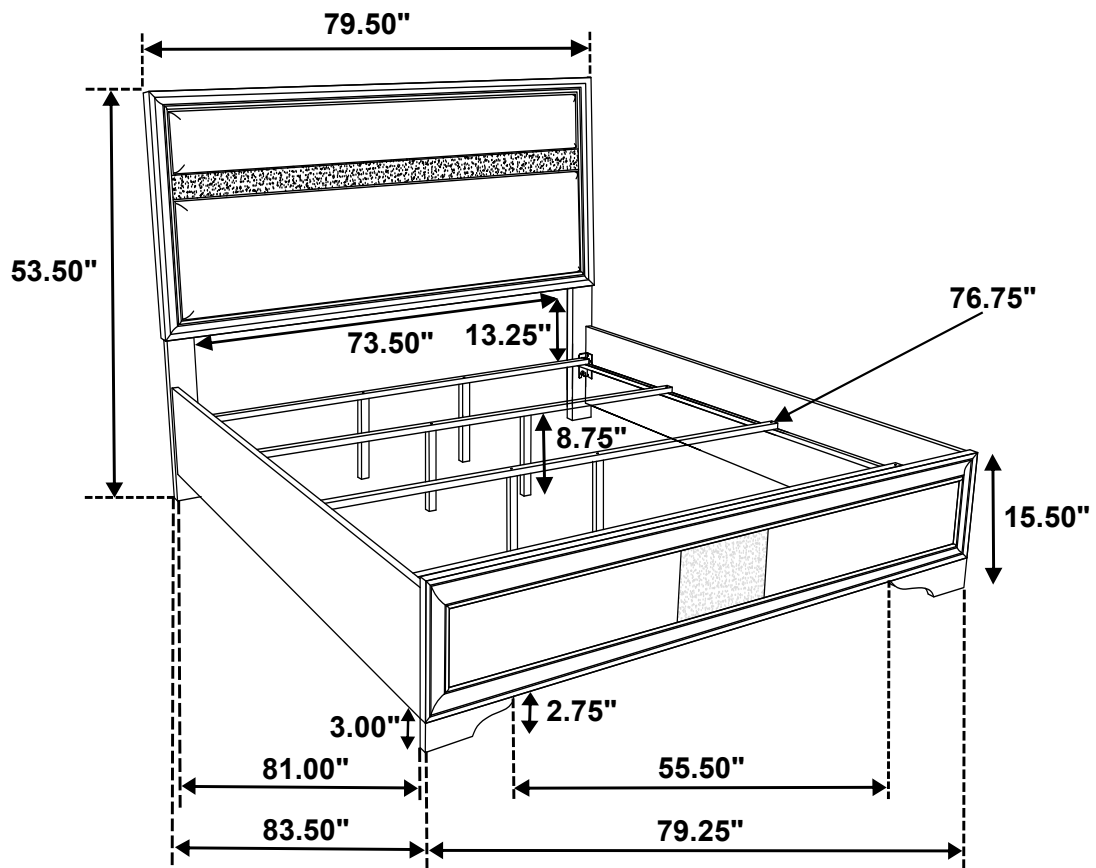

Note : Dimension tolerance $\pm 5\%$