



ASSEMBLY INSTRUCTIONS
COASTER FINE FURNITURE



Fine Furniture for every stage of life

504778
SLEEPER SOFA

ITEM : 504778

ASSEMBLY INSTRUCTIONS



ASSEMBLY TIPS:

- 1.Remove hardware from box and sort by size.
- 2.Please check to see that all hardware and parts are present prior to start of assembly.
- 3.Please follow attached instruction in the same sequence as numbered to assure fast & easy assembly.



WARNING!











- 1.Don't attempt to repair or modify parts that are broken or defective. Please contact the store immediately.
- 2.This product is for home use only and not intended for commercial establishment.





ASSEMBLY TIME

5 MINUTES

PARTS IDENTIFICATION

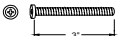
- A LEFT BACK CUSHION  1PC
- B MIDDLE BACK CUSHION  1PC
- C RIGHT BACK CUSHION  1PC
- D SMALL SEAT CUSHION  2PCS
- E LARGE SEAT CUSHION  1PCS
- F SLEEPER SOFA FRAME  1PC
- G OTTOMAN  1PC
- H PATTERNED PILLOW  2PCS
- I PLAIN PILLOW  2PCS
- J LEG  8PCS
- K FOAM PAD  1PC

Z	HARDWARE PACKAGE		
NO	DESCRIPTION	FIGURE	QTY
1	BOLT 5/16" x 3"		8PCS
2	WOOD SCREW M4 x 60mm		8PCS
3	PLASTIC CAP Ø19.5 x 18.5mm		16PCS

ITEM : 504778

ASSEMBLY INSTRUCTIONS



STEP 1

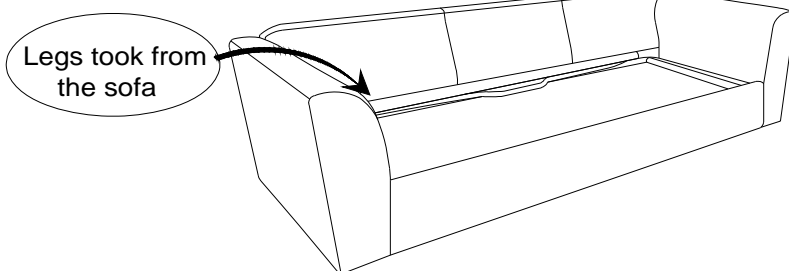

STEP 2

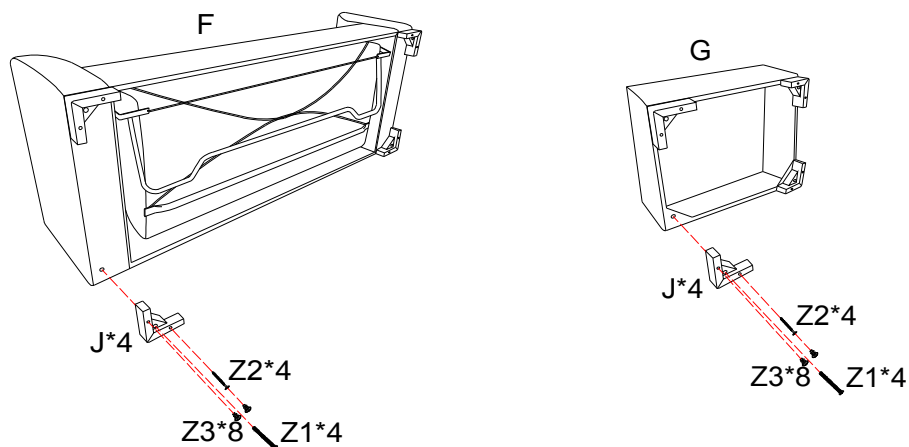

STEP 3

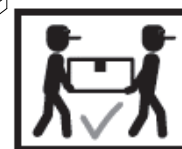
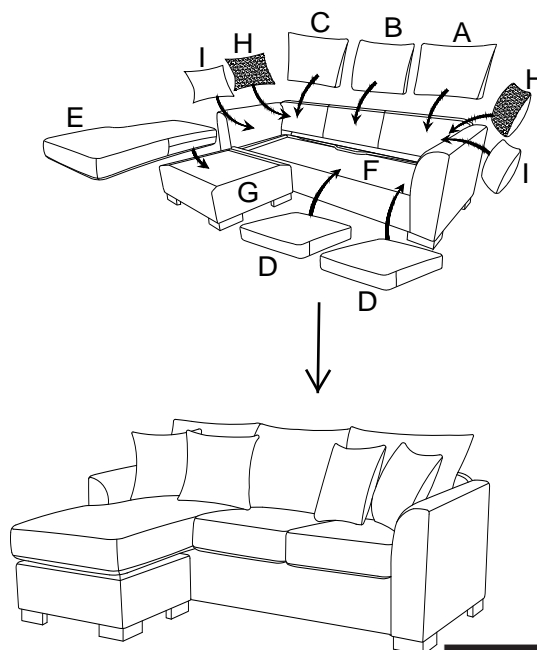
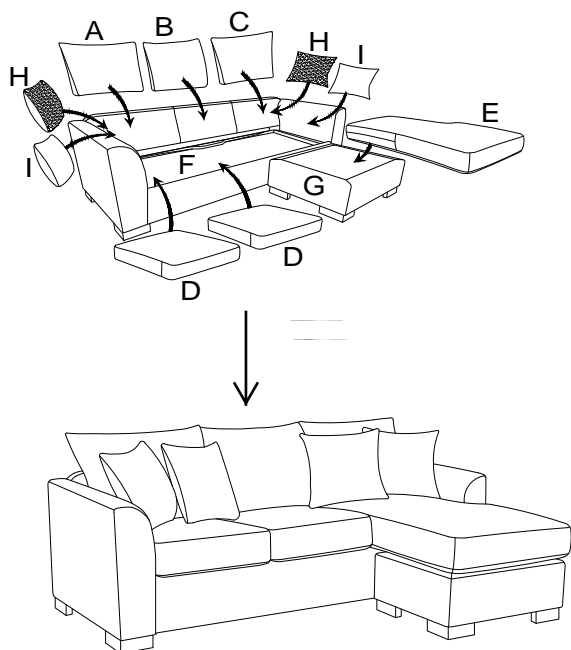

ITEM : 504778

ASSEMBLY INSTRUCTIONS



STEP 1

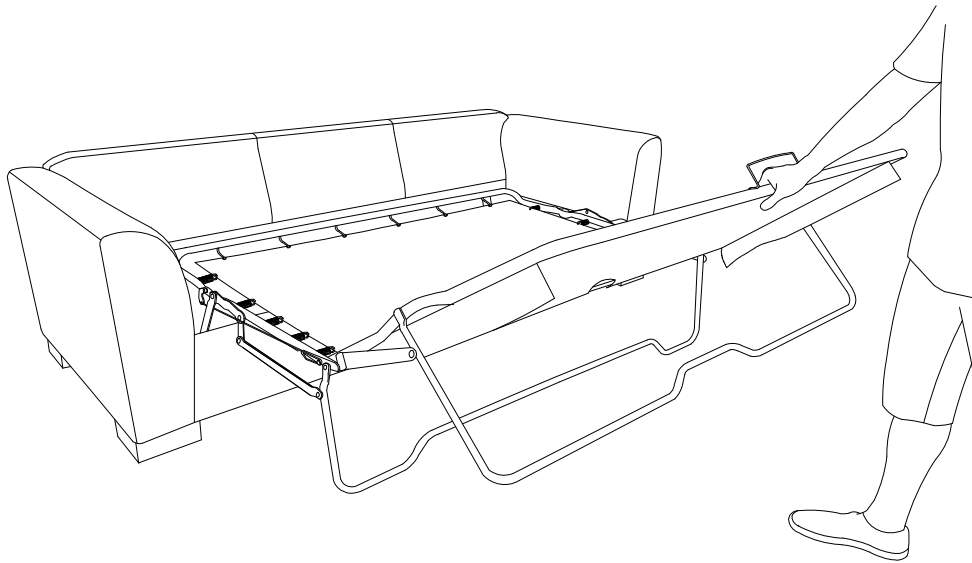

STEP 2

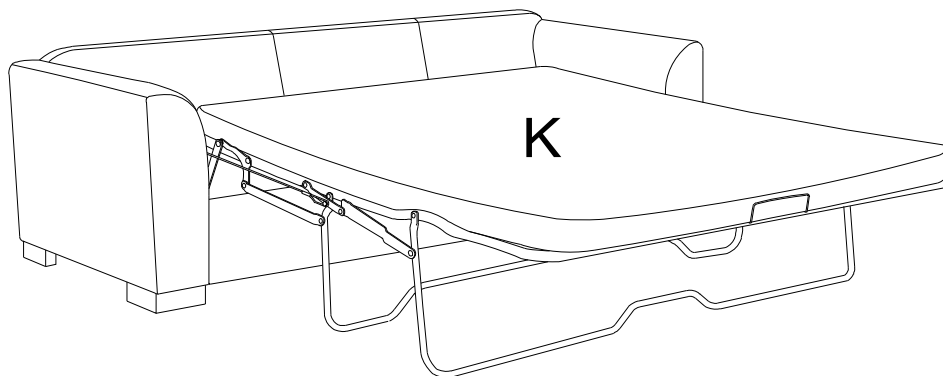

STEP 3

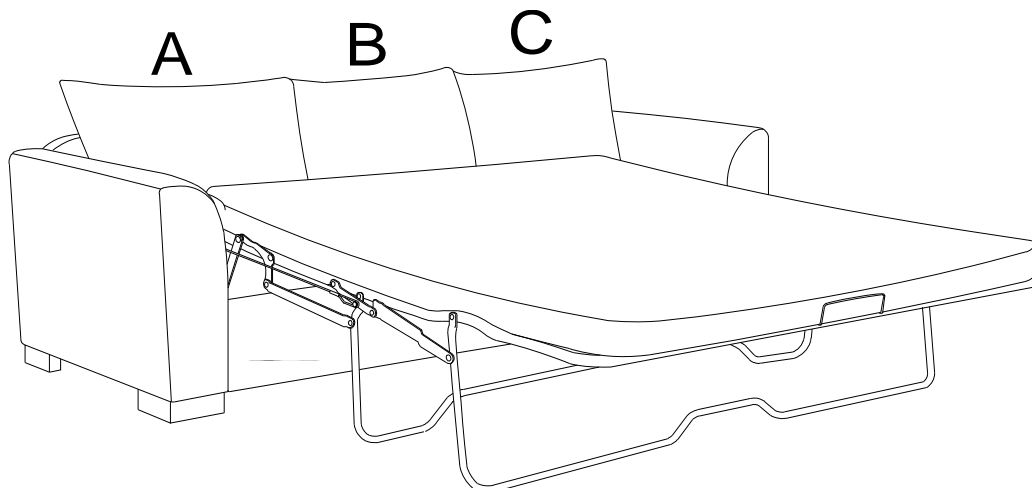

ITEM : 504778

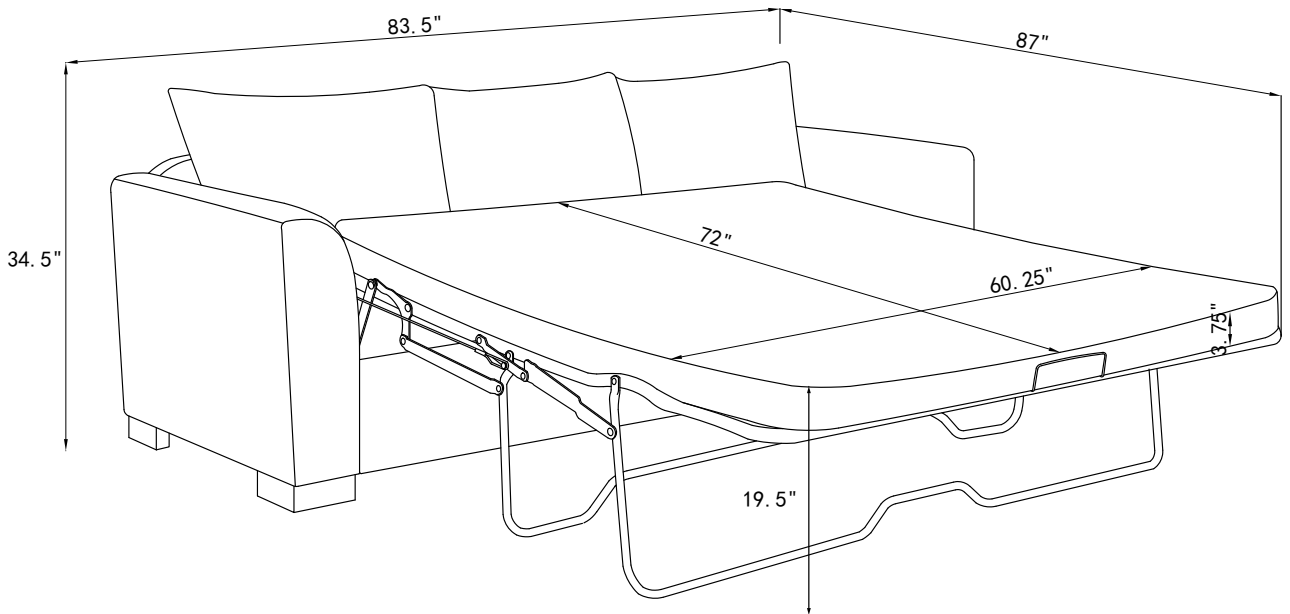
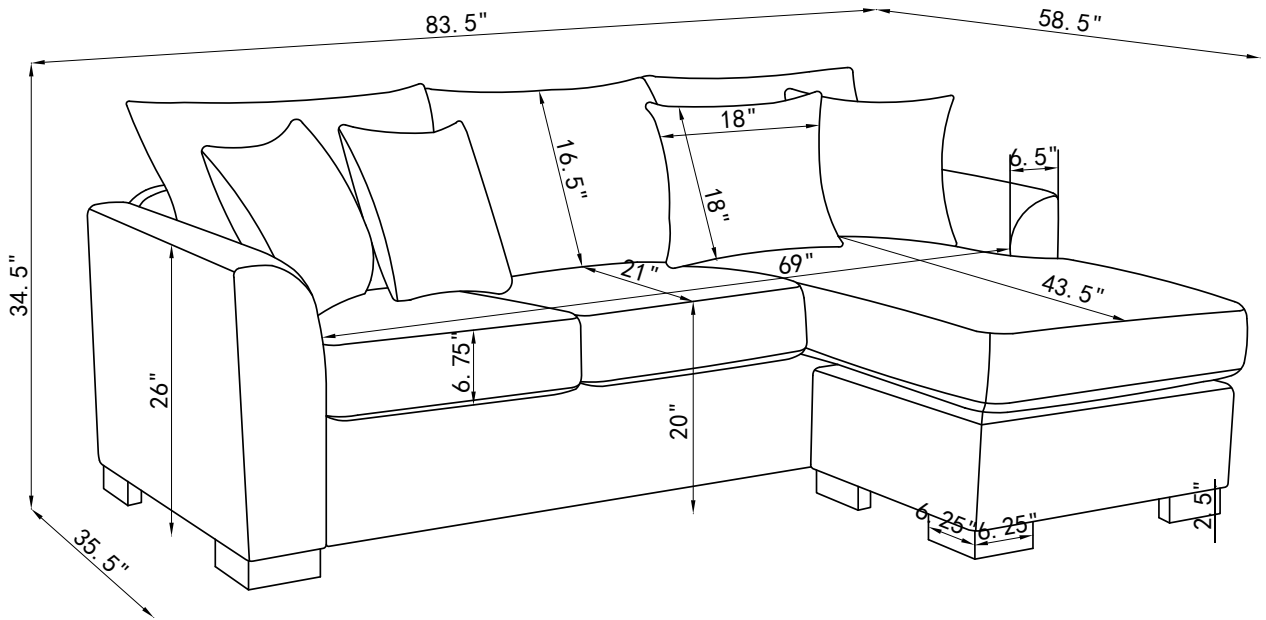

Note: Dimension tolerance $\pm 5\%$

