

ASSEMBLY INSTRUCTIONS
COASTER FINE FURNITURE

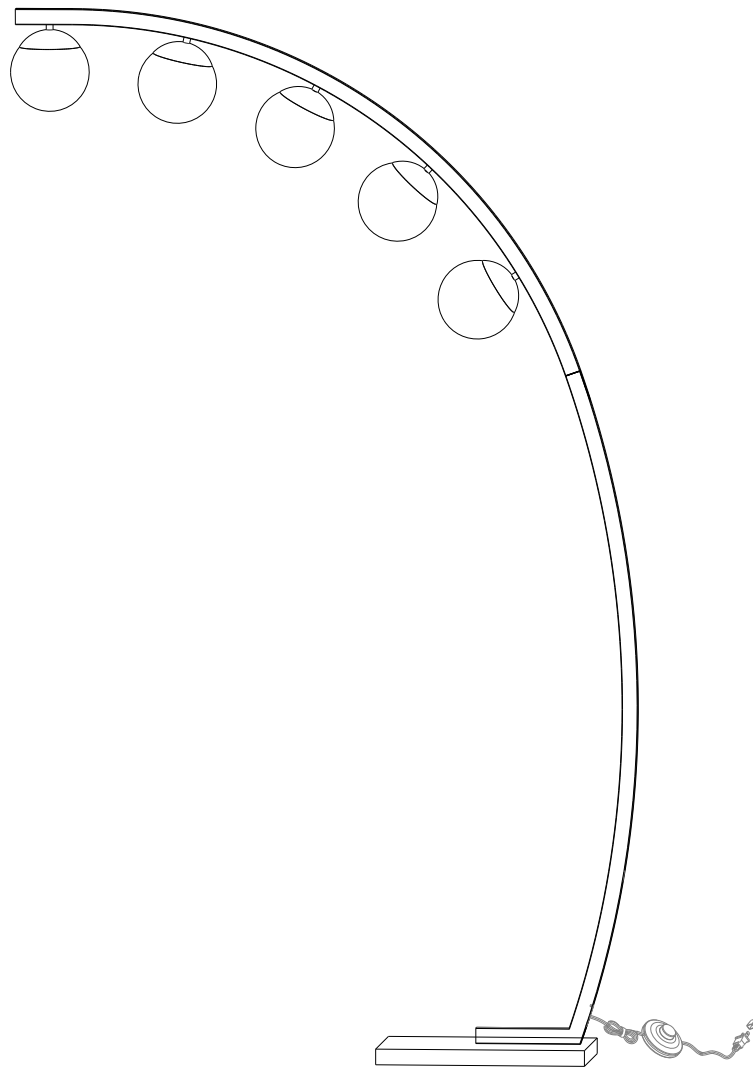

Fine Furniture for every stage of life

REVISION ON:01/04/2024

920242
FLOOR LAMP

ASSEMBLY INSTRUCTIONS

ASSEMBLY TIPS:

1. Remove hardware from box and sort by size.
2. Please check to see that all hardware and parts are present prior to start of assembly.
3. Please follow attached instructions in the same sequence as numbered to assure fast & easy assembly.

WARNING!



1. Don't attempt to repair or modify parts that are broken or defective. Please contact the store immediately
2. This product is for home use only and not intended for commercial establishments.

ASSEMBLY TIME

20 MINUTES

PARTS IDENTIFICATION

A MARBLE BASE

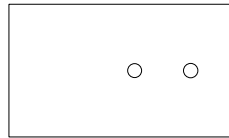

1PC

B LAMP BODY

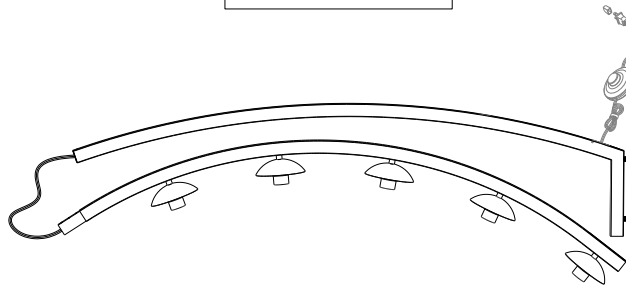

1PC

C LIGHT BULB

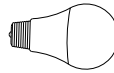

5PCS

D GLASS SHADE

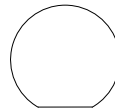

5PCS

HARDWARE IDENTIFICATION

1 SCREW DRIVER

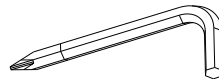

1PC

2 TUBE WRENCH

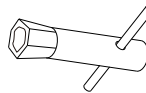

1PC

3 WASHER



2PCS

4 NUT



2PCS

5 SCREWS



3PCS

ITEM :920242

ASSEMBLY INSTRUCTIONS

STEP1

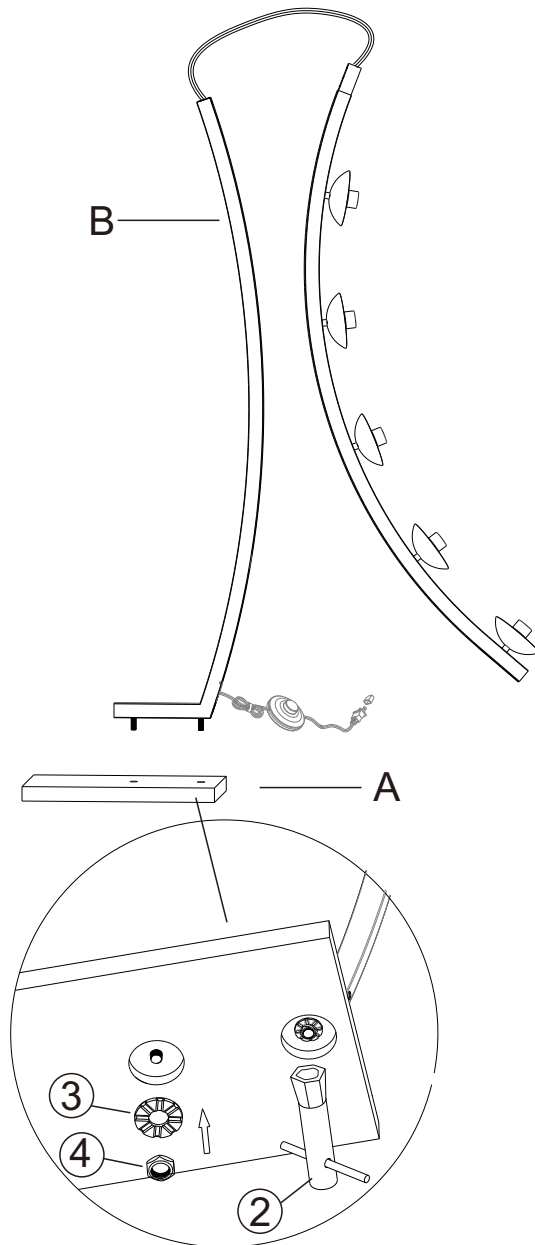

STEP2

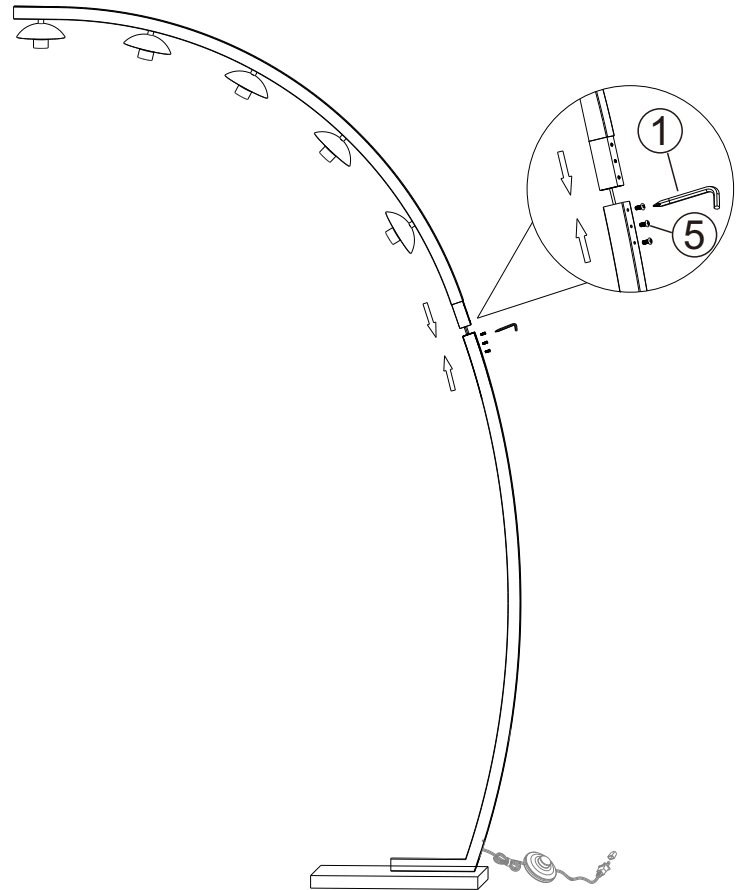

As a safety feature, and to reduce the risk of electric shock, this portable lamp includes a polarized plug (one blade is wider than the other). The plug will fit into a polarized outlet in a single direction only. If the plug does not fit fully in the outlet, reverse the plug and try again. If it still does not fit, contact a qualified electrician. DO NOT use with an extension cord unless, can be fully inserted. DO NOT alter the plug

FLOOR LAMP:TYPE A LED BULB 9W

ITEM :920242

ASSEMBLY INSTRUCTIONS

STEP3

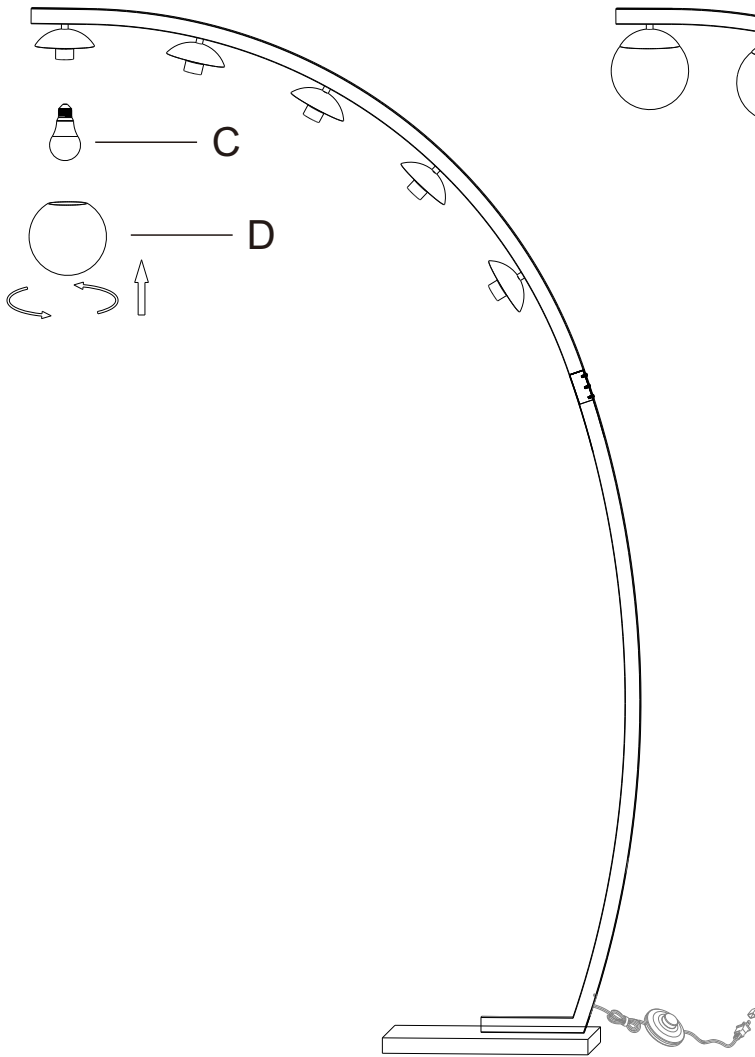

STEP4

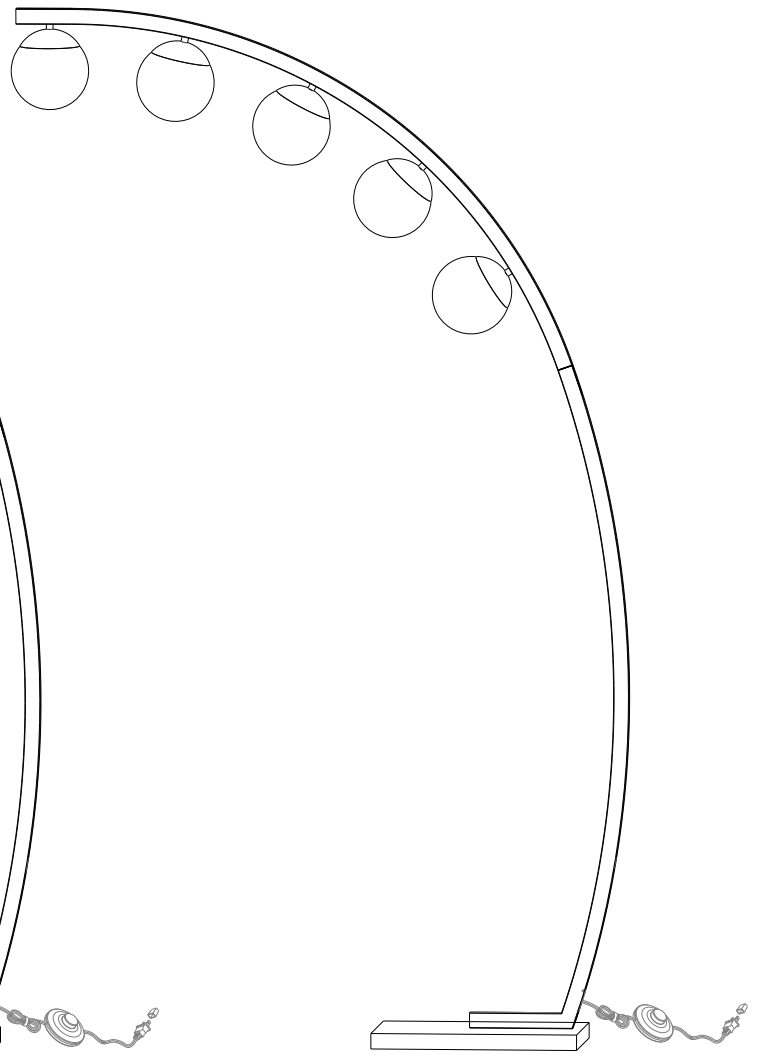

As a safety feature, and to reduce the risk of electric shock, this portable lamp includes a polarized plug (one blade is wider than the other). The plug will fit into a polarized outlet in a single direction only. If the plug does not fit fully in the outlet, reverse the plug and try again. If it still does not fit, contact a qualified electrician. DO NOT use with an extension cord unless, can be fully inserted. DO NOT alter the plug

FLOOR LAMP:TYPE A LED BULB 9W

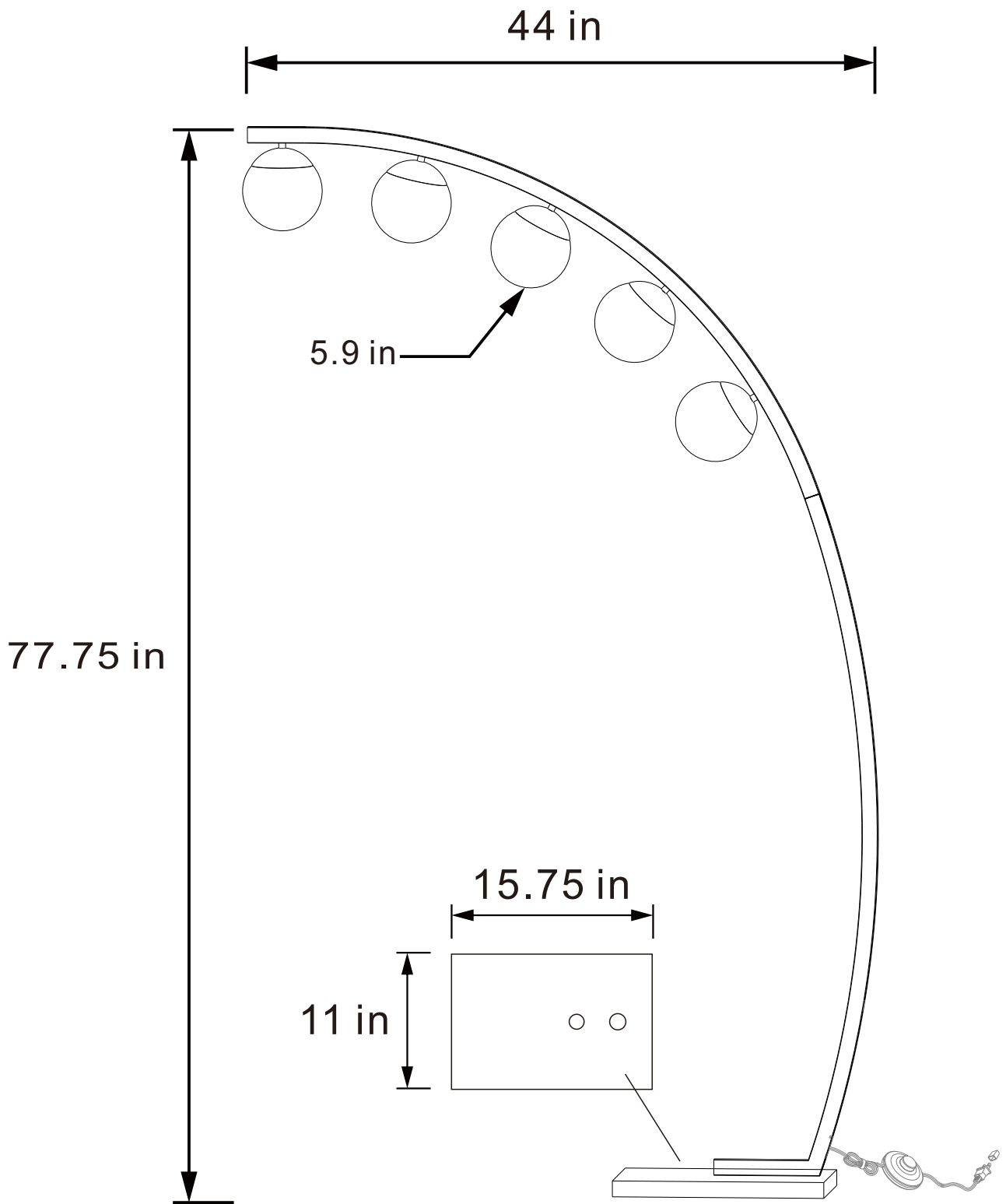

Note : Dimension tolerance $\pm 5\%$