



ASSEMBLY INSTRUCTIONS

COASTER FINE FURNITURE



Fine Furniture for every stage of life

508803
CHAIR

ITEM: 508803

ASSEMBLY INSTRUCTIONS

ASSEMBLY TIPS:

1. Remove hardware from box and sort by size.
2. Please check to see that all hardware and parts are present prior to start of assembly.
3. Please follow attached instructions in the same sequence as numbered to assure fast & easy assembly.



WARNING!

1. Don't attempt to repair or modify parts that are broken or defective. Please contact the store immediately.
2. This product is for home use only and not intended for commercial establishments.

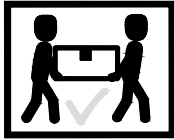

ASSEMBLY TIME

10 MINUTES



PARTS IDENTIFICATION

A CHAIR BASE



1PC

B BACK CUSHION



1PC

C LEG

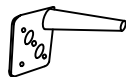

4PCS

Z HAREWARE IDENTIFICATION

1 WASHER
(M6-SR)



8 PCS

2 BOLT
(M6*30-GD)



8 PCS

3 ALLEN KEY
(M6-GD)



1 PC

ITEM: 508803

ASSEMBLY INSTRUCTIONS
STEP 1

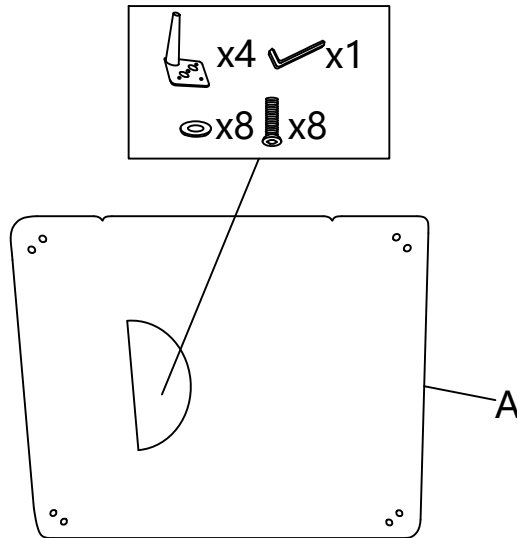

STEP 2

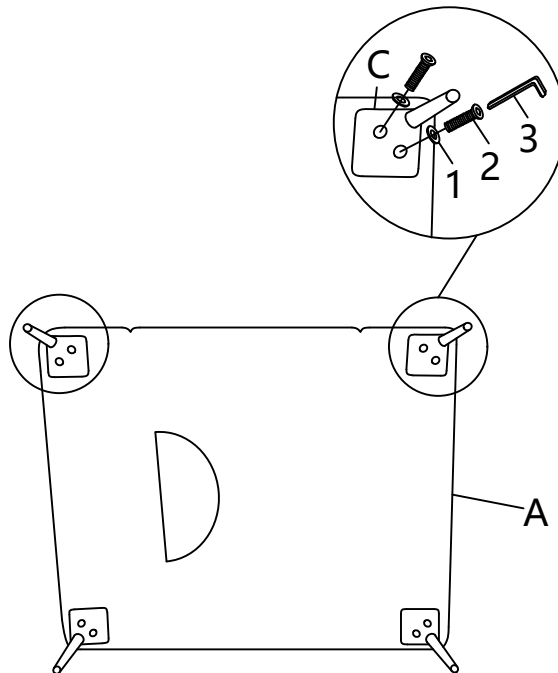

ITEM: 508803

ASSEMBLY INSTRUCTIONS
STEP 3

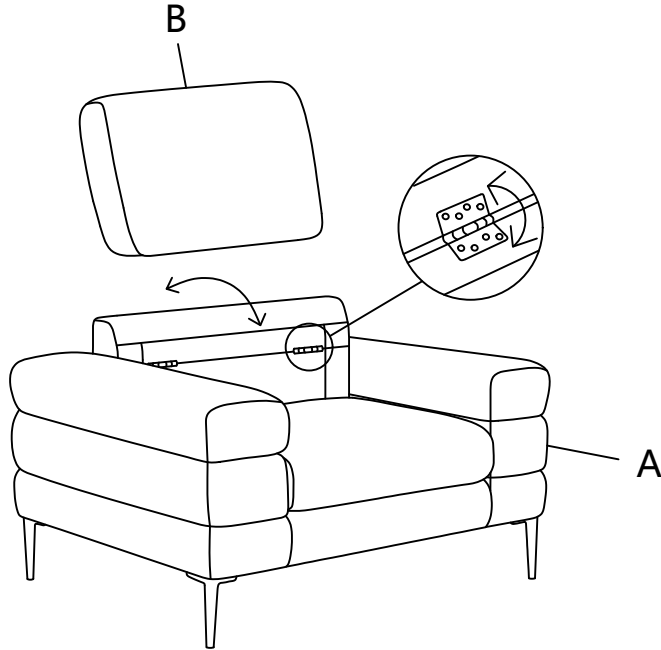

STEP 4

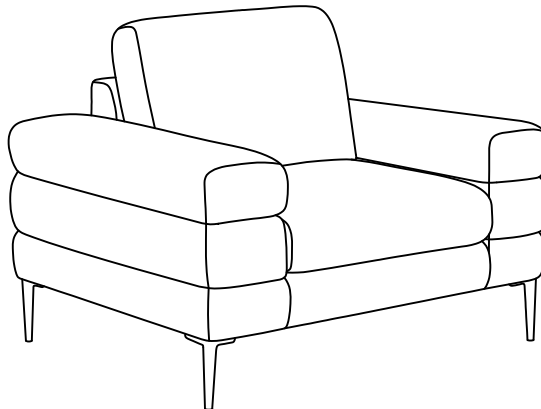

ITEM: 508803

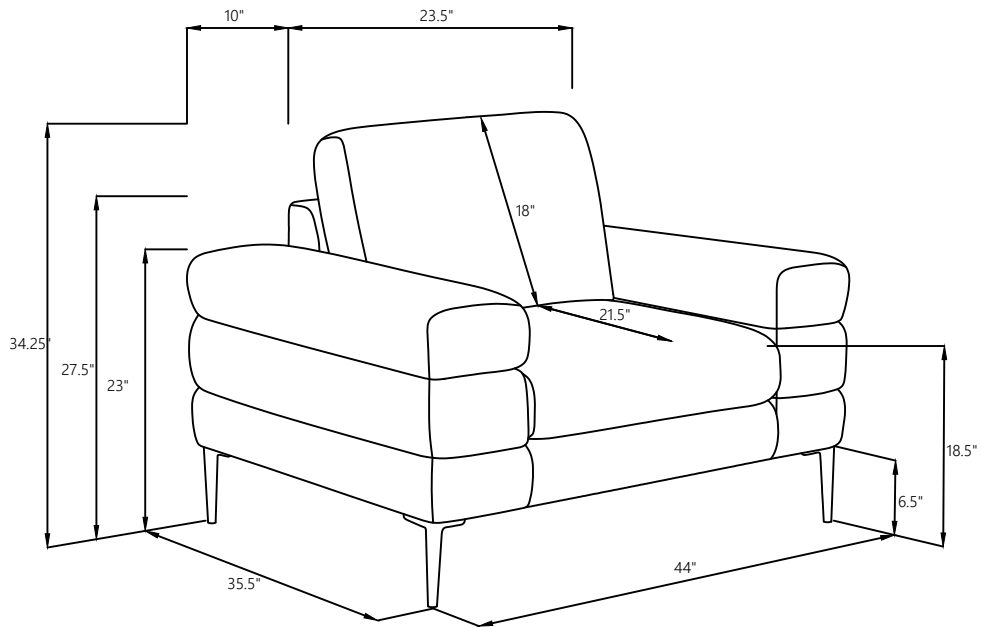

Note: Dimension tolerance $\pm 5\%$

