

ASSEMBLY INSTRUCTIONS
COASTER FINE FURNITURE



Fine Furniture for every stage of life

930209
VANITY SET

REVISION 0 : 08/14/2024
REVISION 1 : 08/20/2024

ITEM:930209



ASSEMBLY INSTRUCTIONS

ASSEMBLY TIPS:

1. Remove hardware from box and sort by size.
2. Please check to see that all hardware and parts are present prior to start of assembly.
3. Please follow attached instructions in the same sequence as numbered to assure fast & easy assembly.



WARNING!

1. Don't attempt to repair or modify parts that are broken or defective. Please contact the store immediately.
2. This product is for home use only and not intended for commercial establishments.

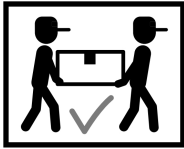

ASSEMBLY TIME 99 MINUTES

PARTS IDENTIFICATION

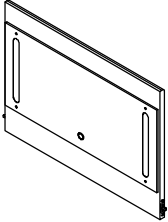
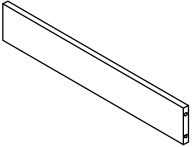
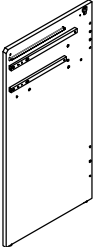
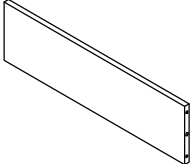
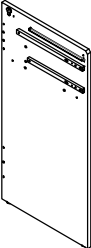
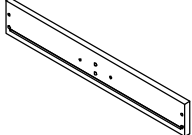
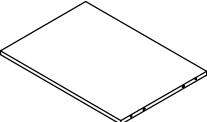
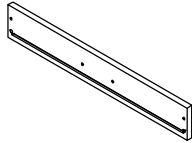
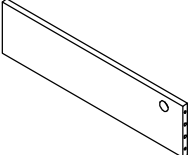
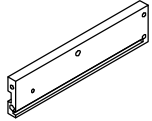
A	TOP PANEL		1PC	F	SMALL SUPPORT PANEL		1PC
B	LEFT PANEL		1PC	G	BOTTOM BACK PANEL		1PC
C	RIGHT PANEL		1PC	H	TOP DRAWER FRONT PANEL		1PC
D	MIDDLE BOTTOM PANEL		1PC	I	BOTTOM DRAWER FRONT PANEL		1PC
E	BACK PANEL		1PC	J	TOP DRAWER LEFT PANEL		1PC

ITEM:930209

ASSEMBLY INSTRUCTIONS

PARTS IDENTIFICATION



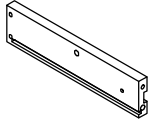
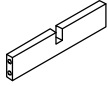
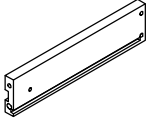
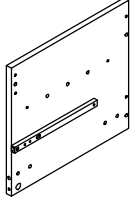
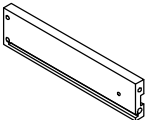
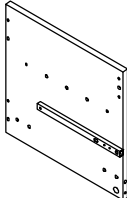
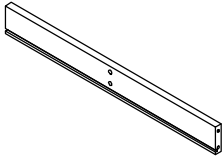
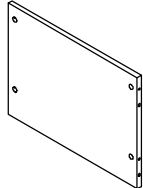
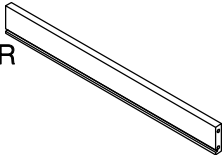
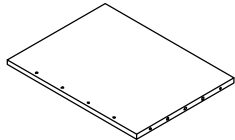
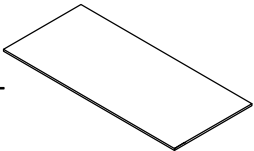
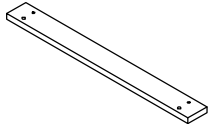
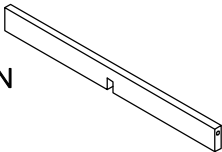
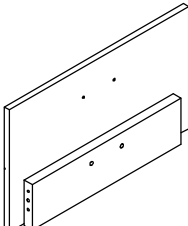



K	TOP DRAWER RIGHT PANEL		1PC	R	SHORT DRAWER INNER PARTITION		1PC
L	BOTTOM DRAWER LEFT PANEL		1PC	S	CHAIR LEFT PANEL		1PC
M	BOTTOM DRAWER RIGHT PANEL		1PC	T	CHAIR RIGHT PANEL		1PC
N	TOP DRAWER BACK PANEL		1PC	U	CHAIR BACK PANEL		1PC
O	BOTTOM DRAWER BACK PANEL		1PC	V	CHAIR MIDDLE PANEL		1PC
P	DRAWER BOTTOM PANEL		2PCS	A1	CHAIR BOTTOM FRONT PANEL		1PC
Q	LONG DRAWER INNER PARTITION		1PC	A2	CHAIR TOP FRONT PANEL		1PC

ITEM:930209

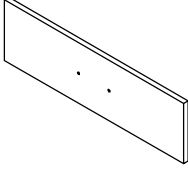
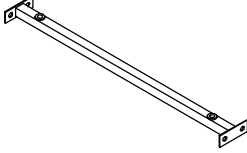
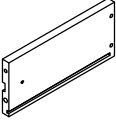

ASSEMBLY INSTRUCTIONS

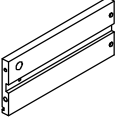
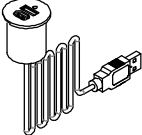
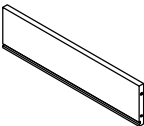
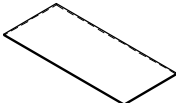
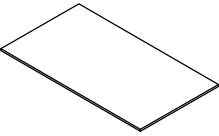
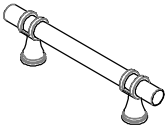
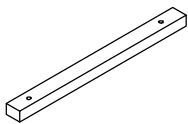
PARTS IDENTIFICATION

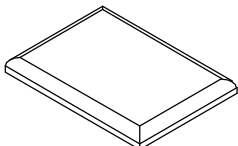
A3	CHAIR DRAWER FRONT PANEL		1PC	A10	CROSSBAR		2PCS
A4	CHAIR DRAWER LEFT PANEL		1PC	A11	POWER ADAPTER		1PC
A5	CHAIR DRAWER RIGHT PANEL		1PC	A12	USB PORT		1PC
A6	CHAIR DRAWER BACK PANEL		1PC	A13	TOP GLASS		1PC
A7	CHAIR DRAWER BOTTOM PANEL		1PC	A14	HANDLE		5PCS
A8	CUSHION SUPPORT PANEL		2PCS	A15	WHEEL		4PCS
A9	CUSHION SEAT		1PC				

















ITEM:930209

ASSEMBLY INSTRUCTIONS



Z

HARDWARE IDENTIFICATION

1	LARGE CAM BOLT (35MM)		28PCS	11	STICKER		30PCS
2	LARGE CAM-LOCK (Ø15MM)		28PCS	12	SHELF PIN		4PCS
3	WOOD DOWEL (8 x 30mm)		40PCS	13	GLUE		1PC
4	LONG SCREW (8 x 38mm)		16PCS	14	SCREWDRIVER		1PC
5	SCREW (3.5 x 28mm)		4PCS	15	ALLEN WRENCH (4mm)		1PC
6	DRAWER BOLT (5/32" x 12mm)		6PCS	16	HEXAGONAL KEY (8mm)		1PC
7	HANDLE BOLT (M4 x 20mm)		10PCS	17	FOOT PIN		4PCS
8	COARSE THREAD SCREWS (7# x 50mm)		4PCS				
9	BOLT (1/4" x 21mm)		8PCS				
10	SUCTION CUP		4PCS				

ITEM:930209



ASSEMBLY INSTRUCTIONS

STEP 1 Do not tighten until each step is completed or instructed.

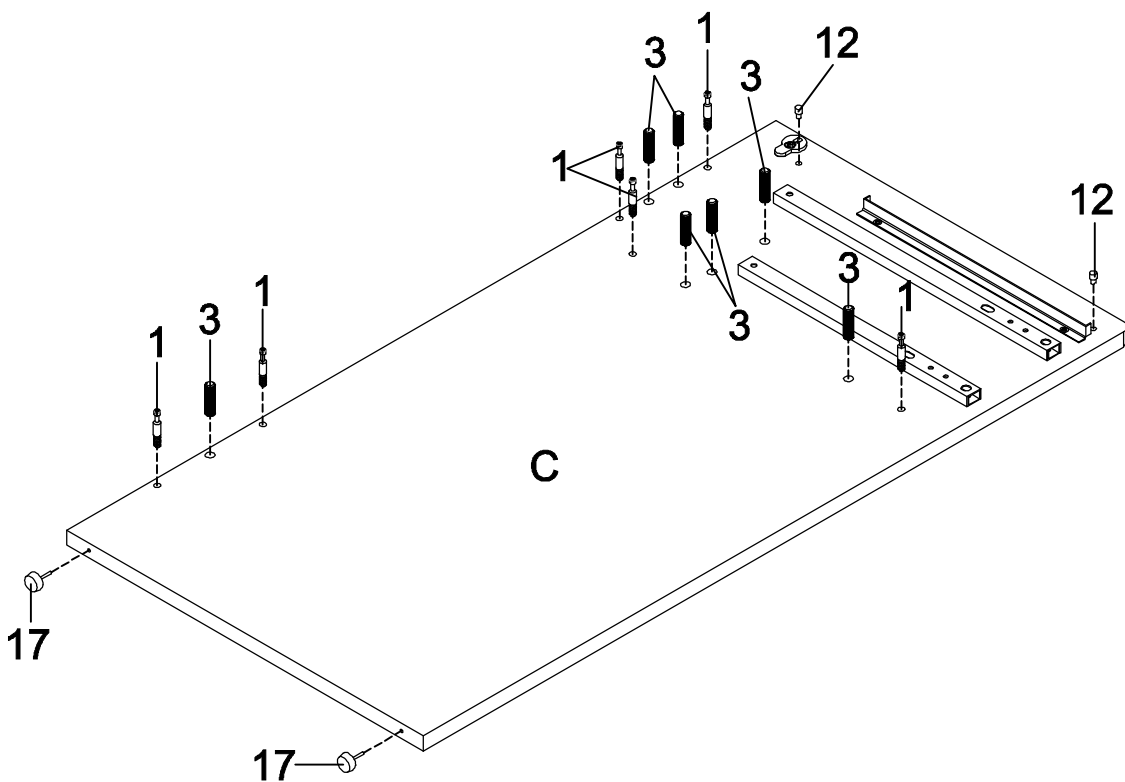
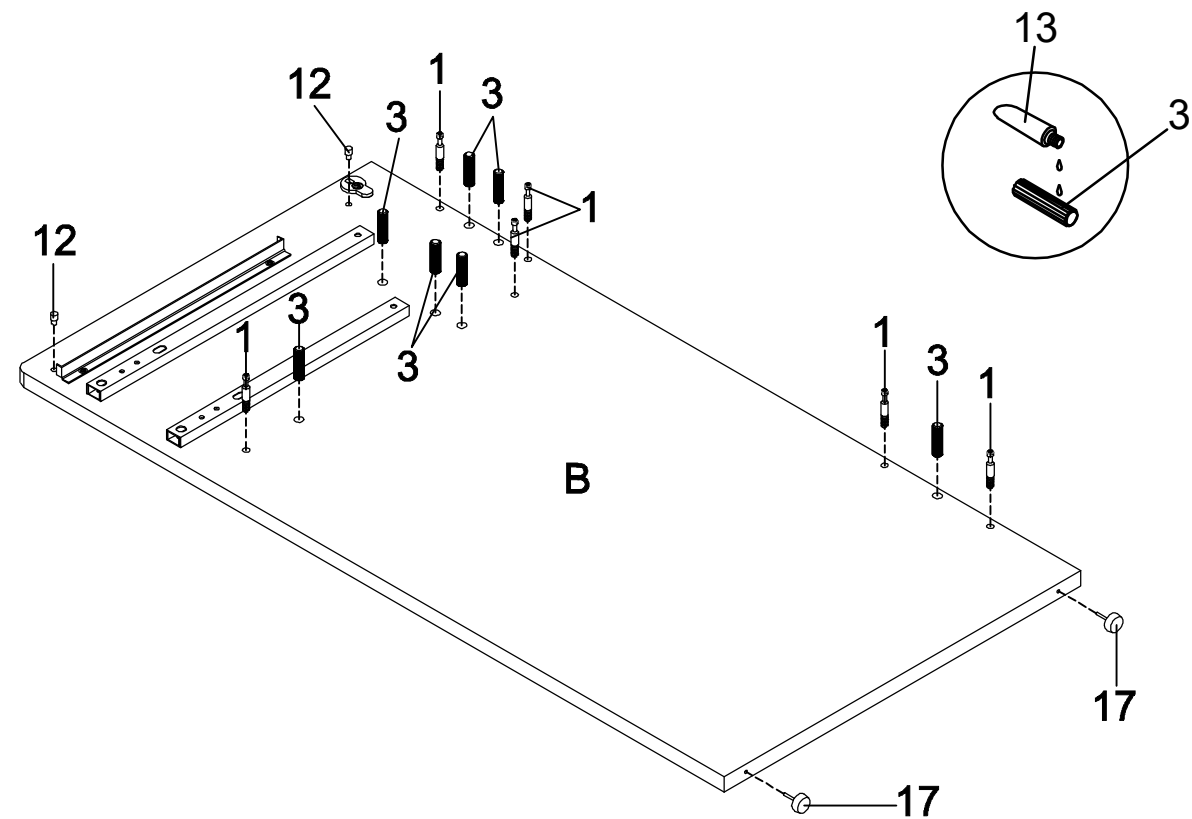

ITEM:930209

ASSEMBLY INSTRUCTIONS

STEP 2

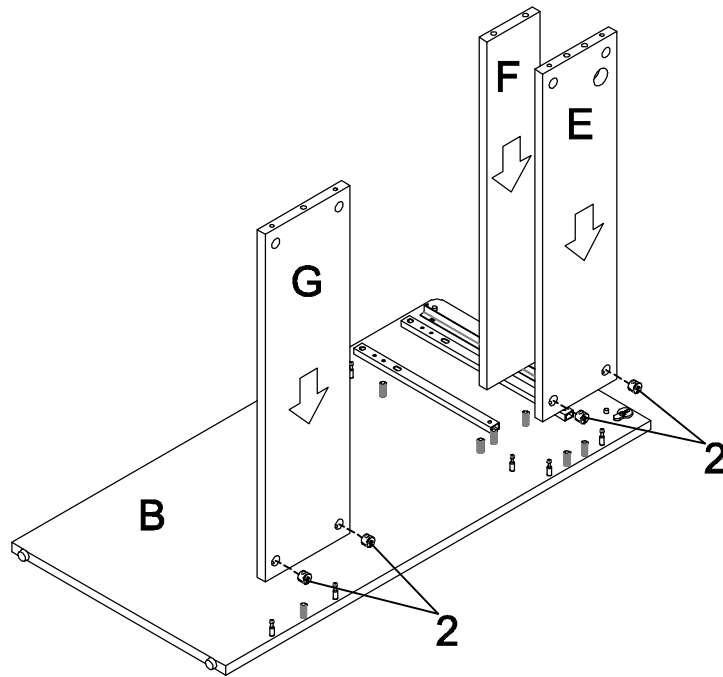

STEP 3

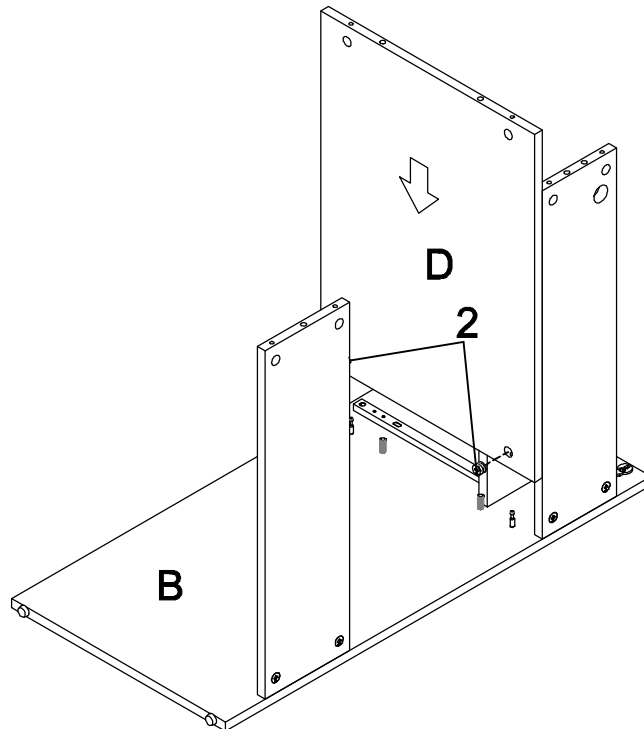

ITEM:930209
ASSEMBLY INSTRUCTIONS
STEP 4

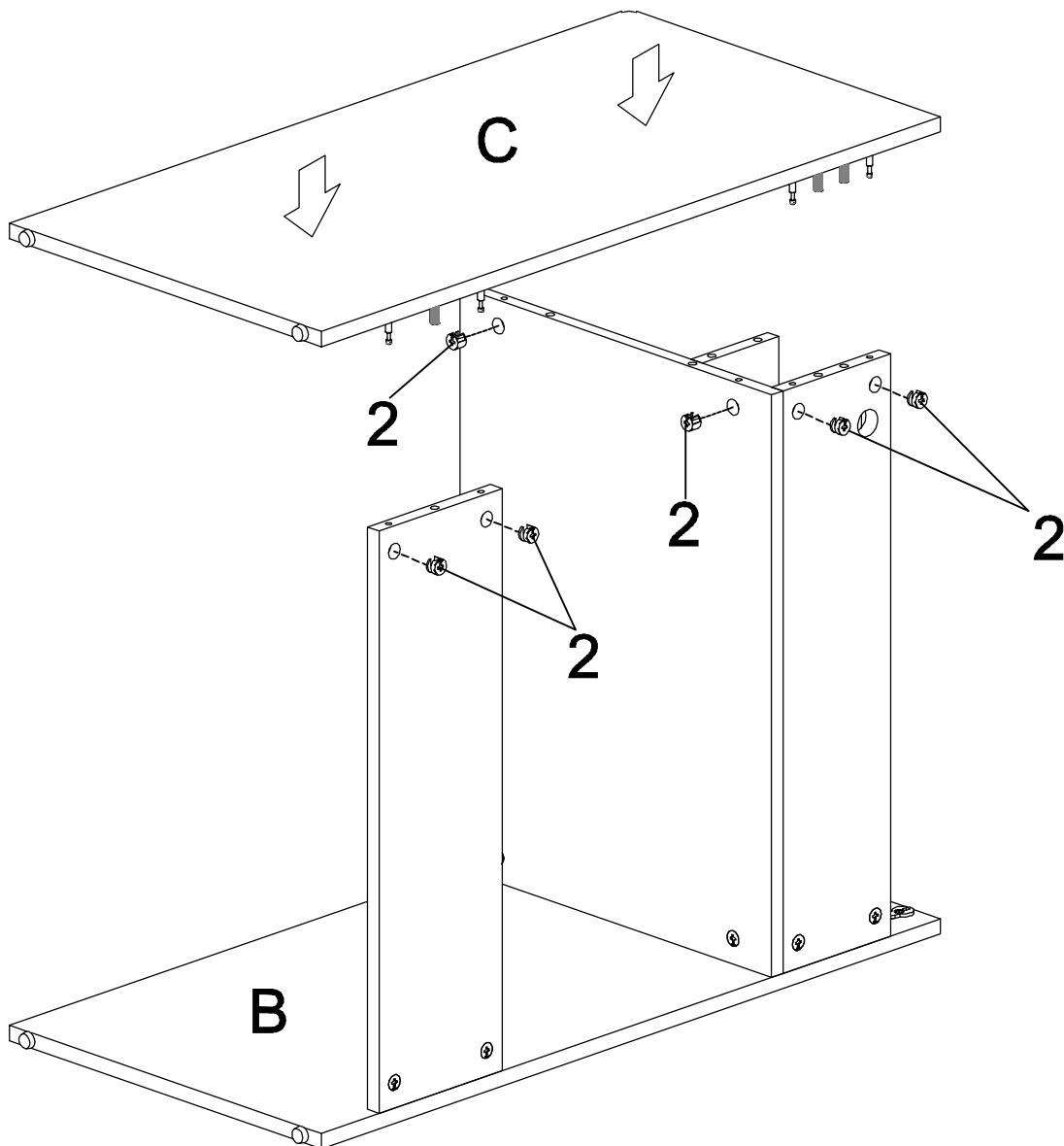

ITEM:930209
ASSEMBLY INSTRUCTIONS
STEP 5

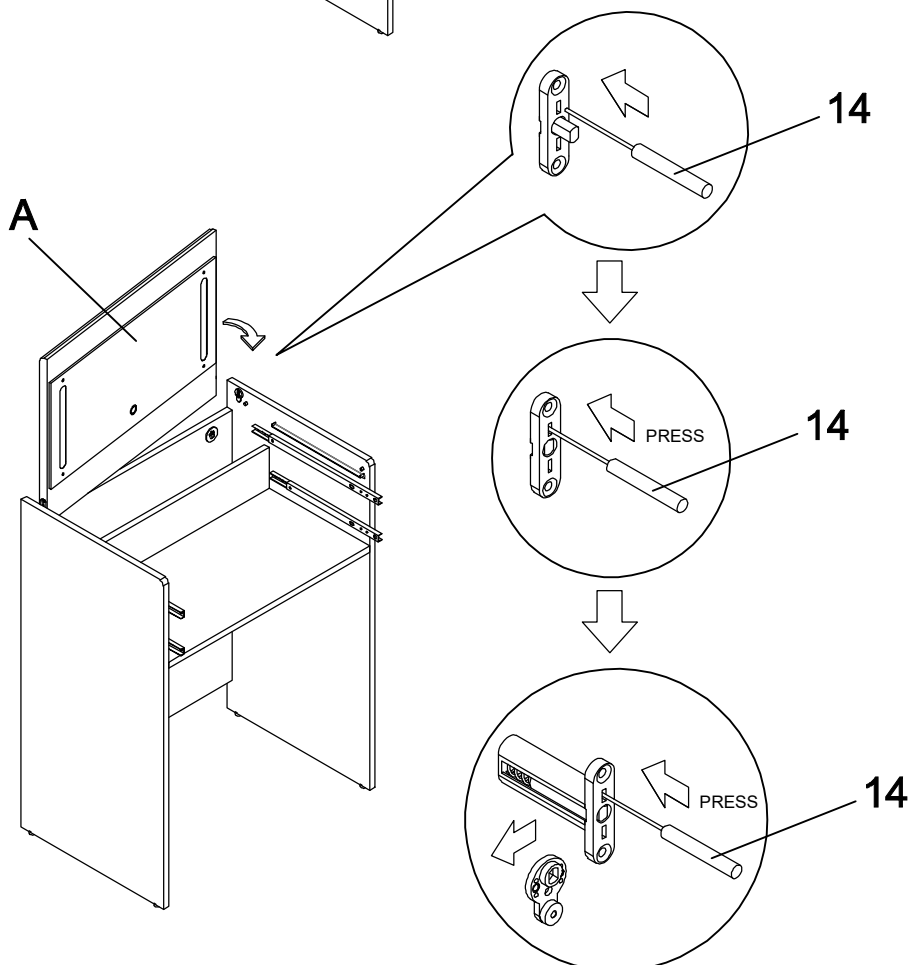
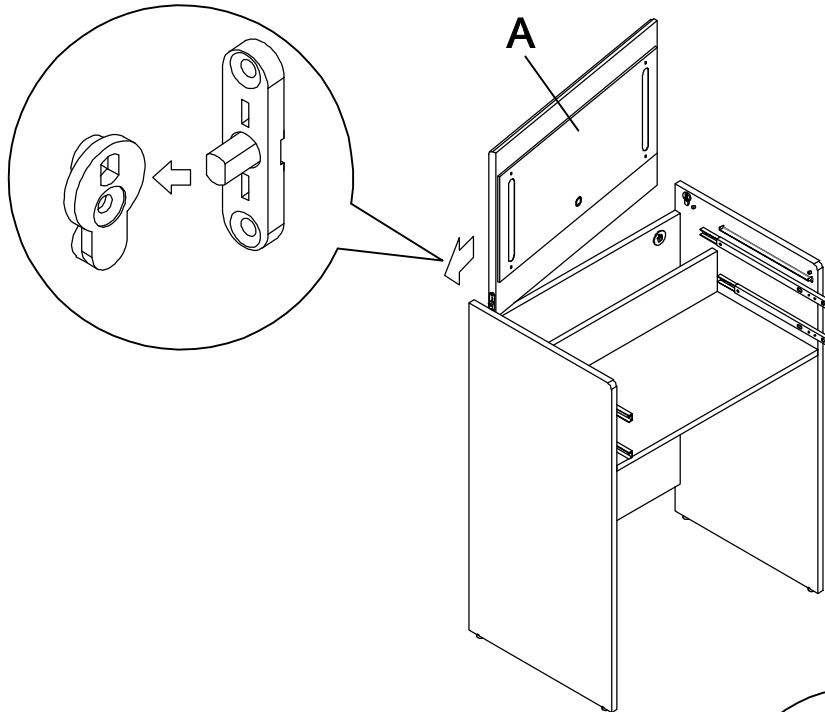

ITEM:930209
ASSEMBLY INSTRUCTIONS
STEP 6

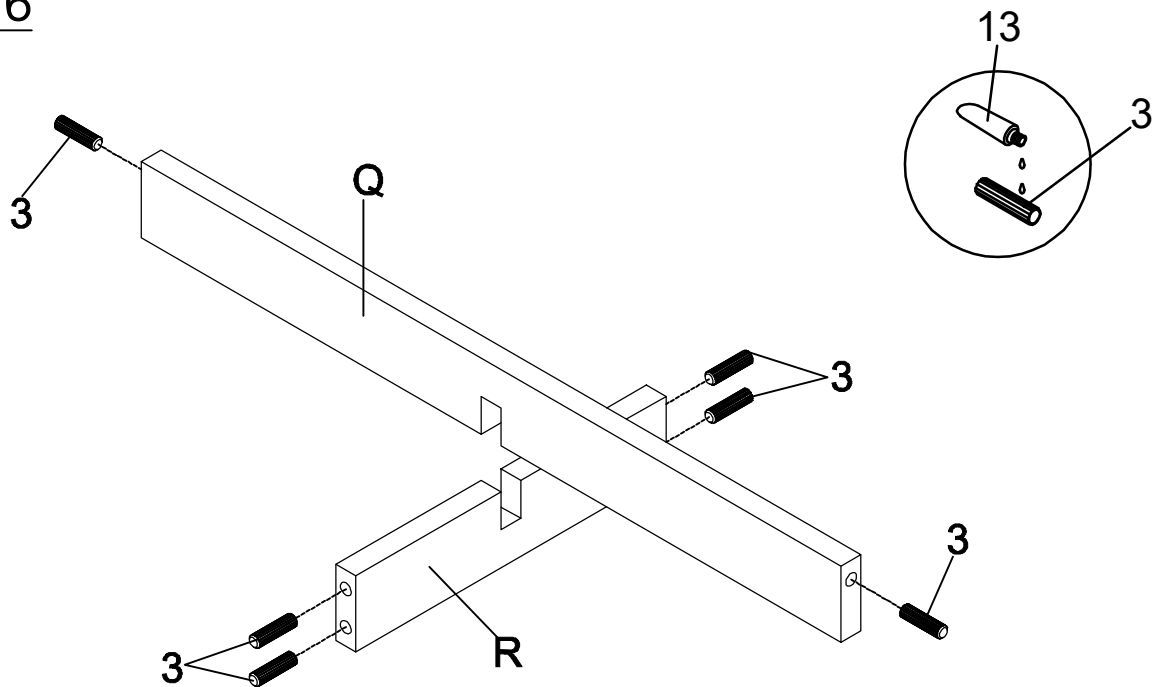

STEP 7

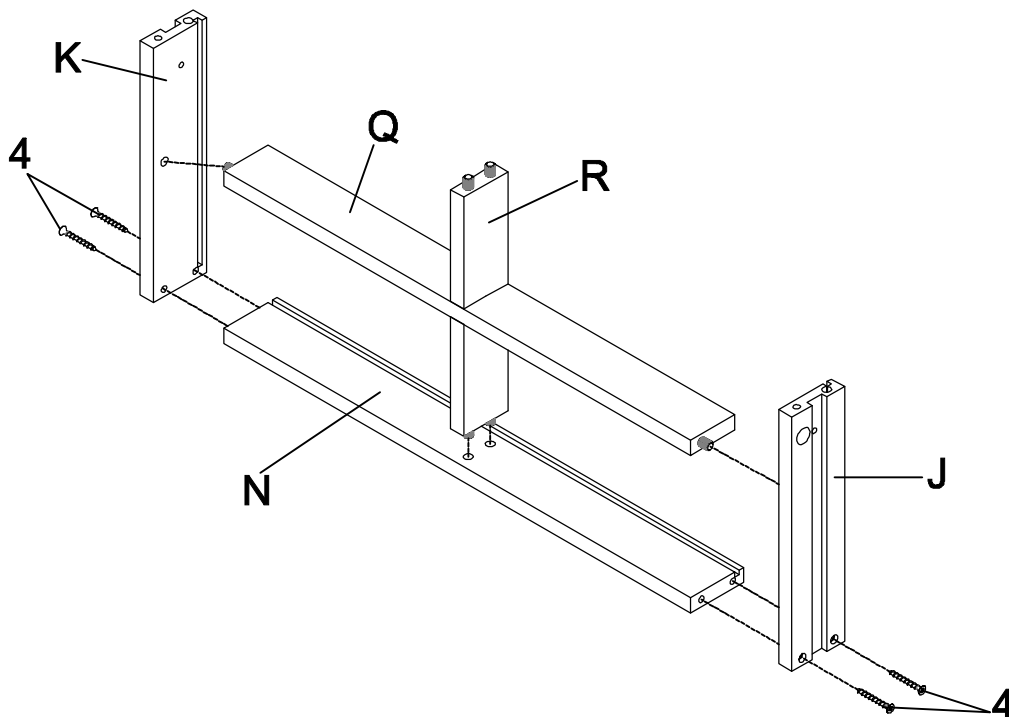

ITEM:930209
ASSEMBLY INSTRUCTIONS
STEP 8

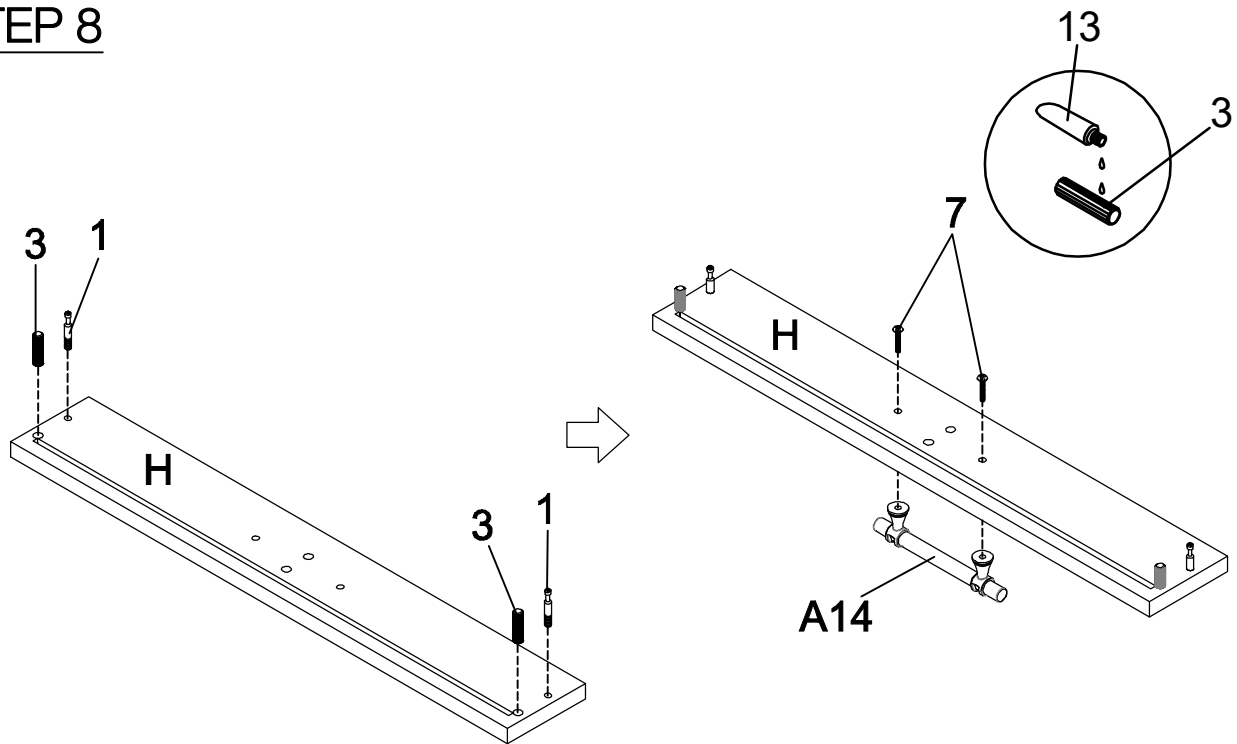

STEP 9

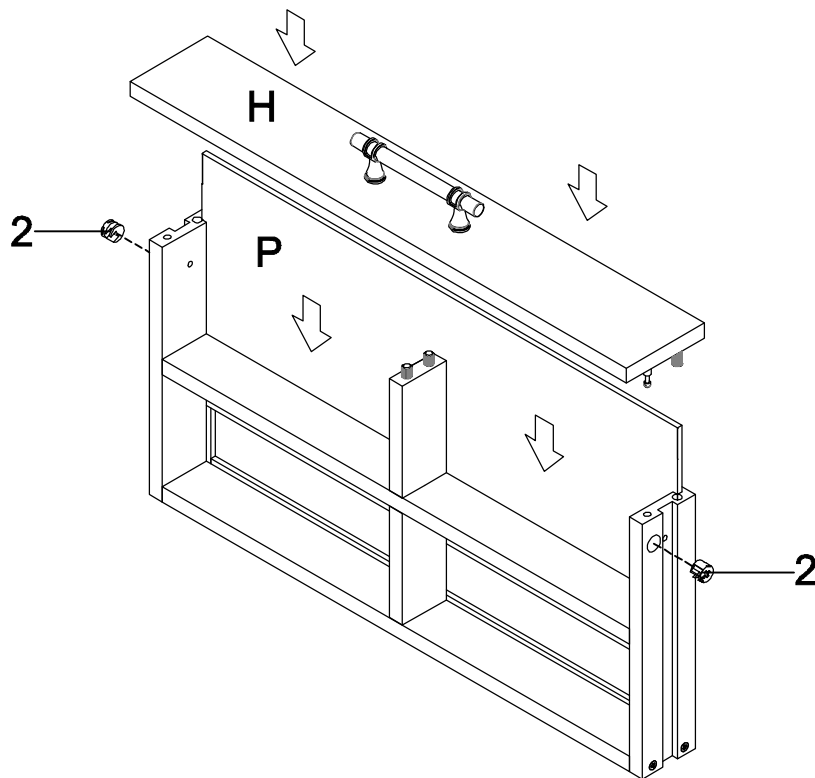

ITEM:930209
ASSEMBLY INSTRUCTIONS
STEP 10

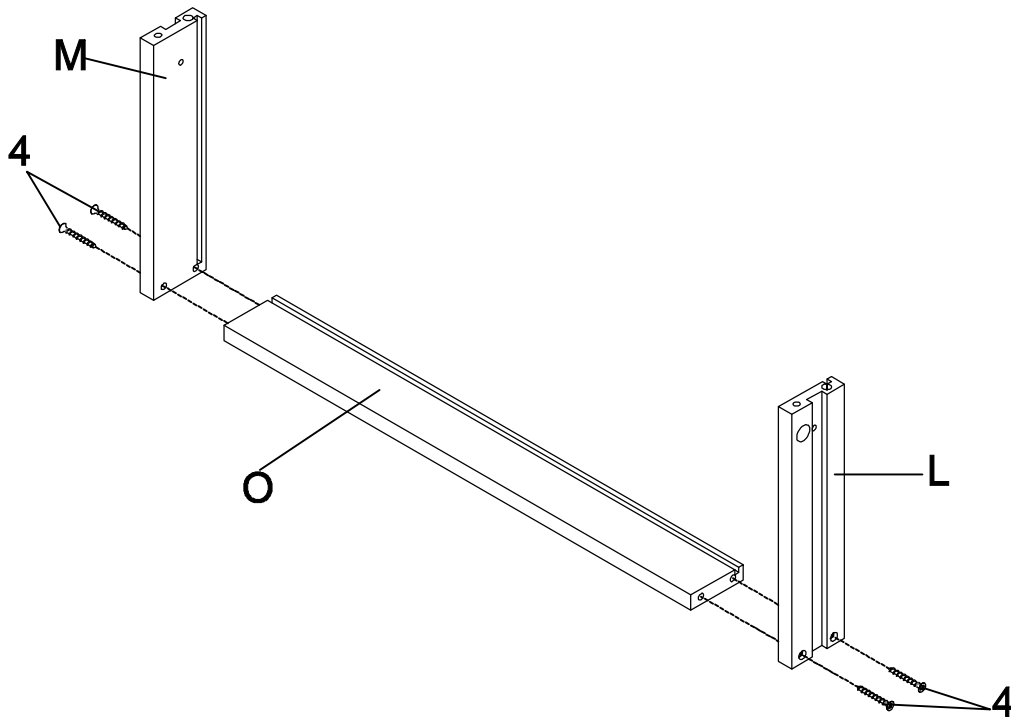

STEP 11

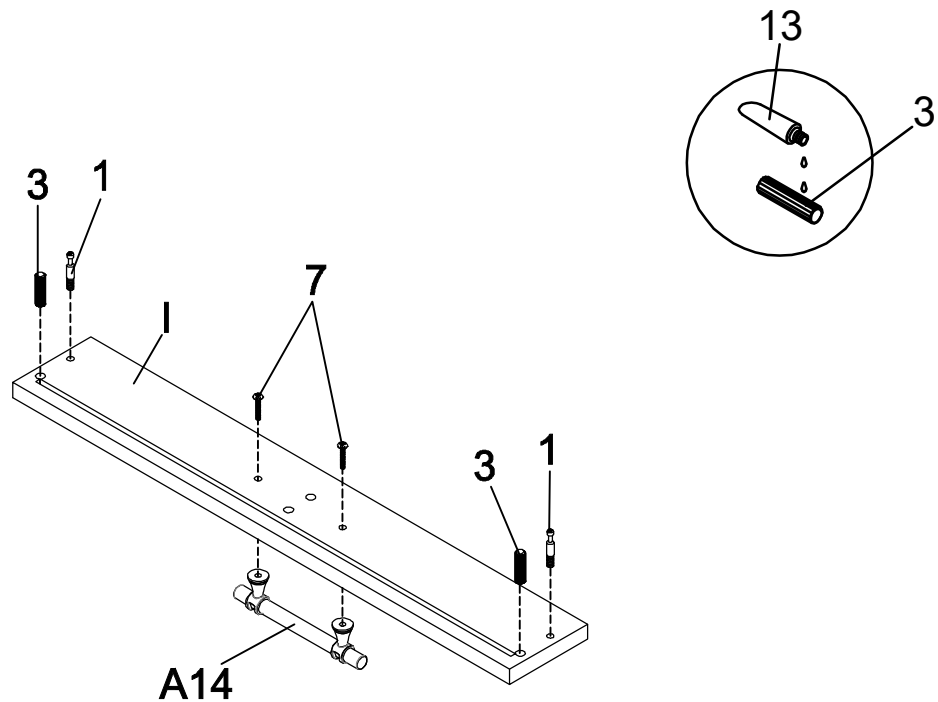

ITEM:930209
ASSEMBLY INSTRUCTIONS
STEP 12

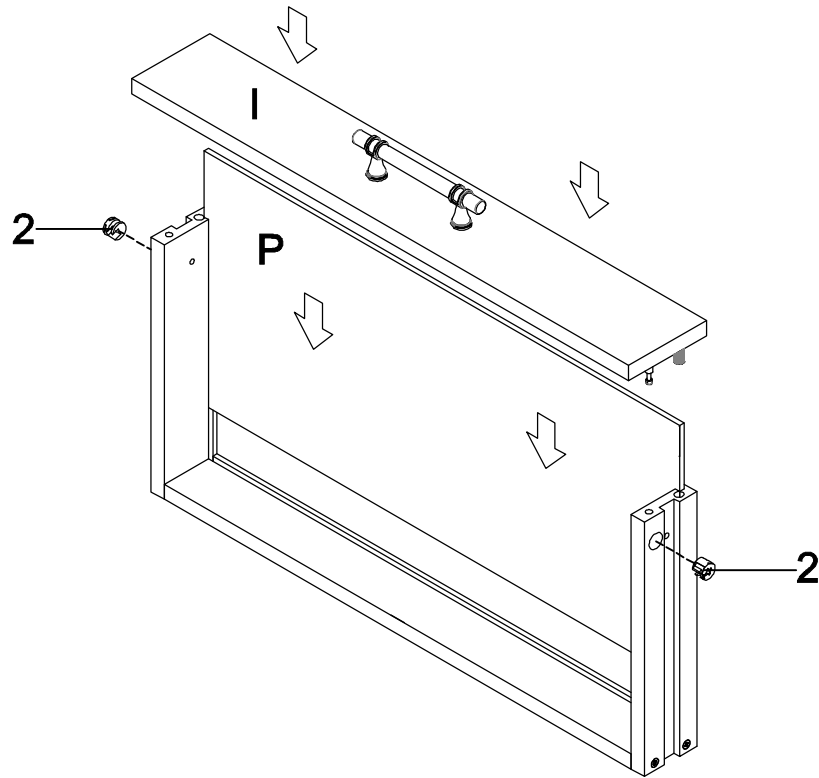

STEP 13

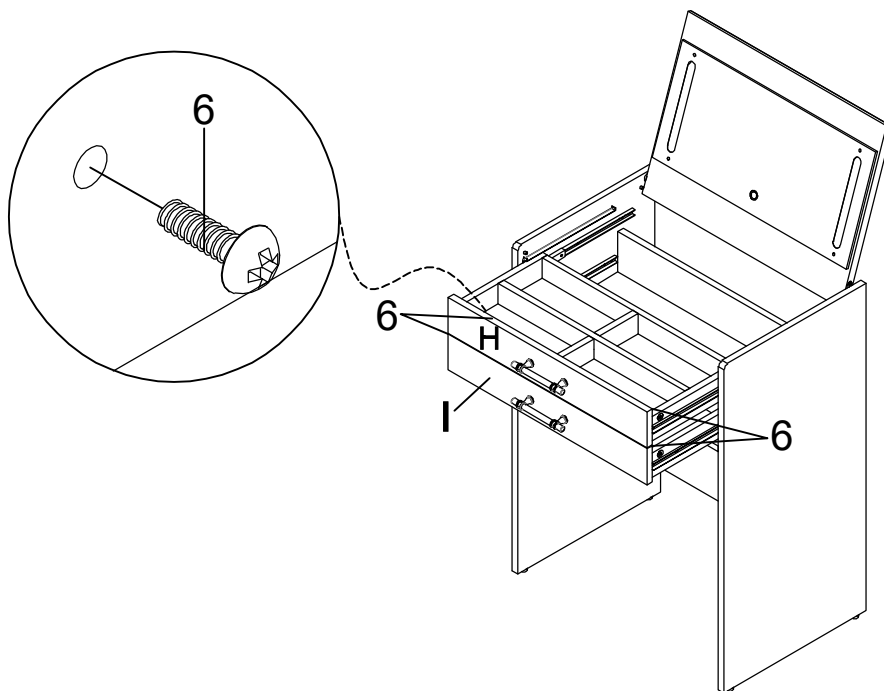

ITEM:930209
ASSEMBLY INSTRUCTIONS
STEP 14

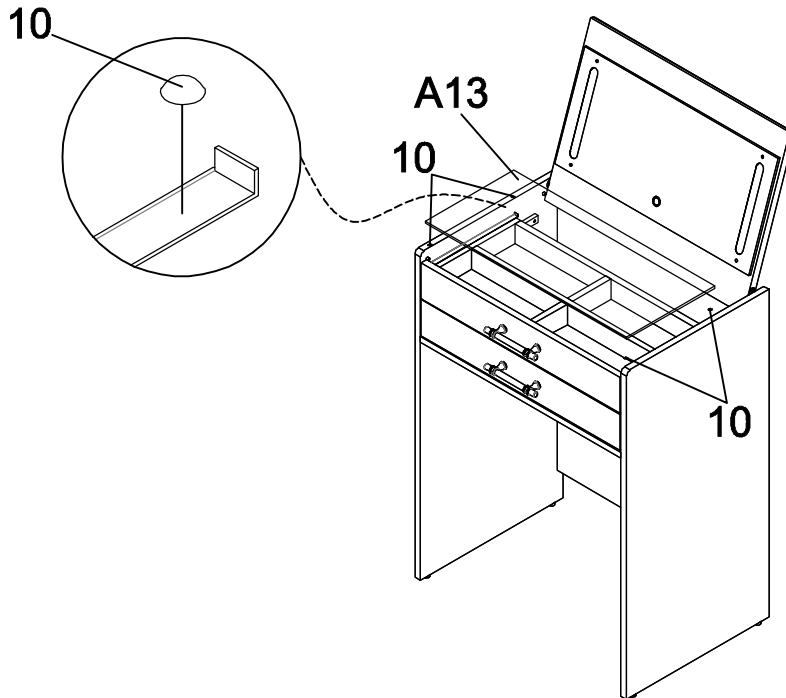

STEP 15

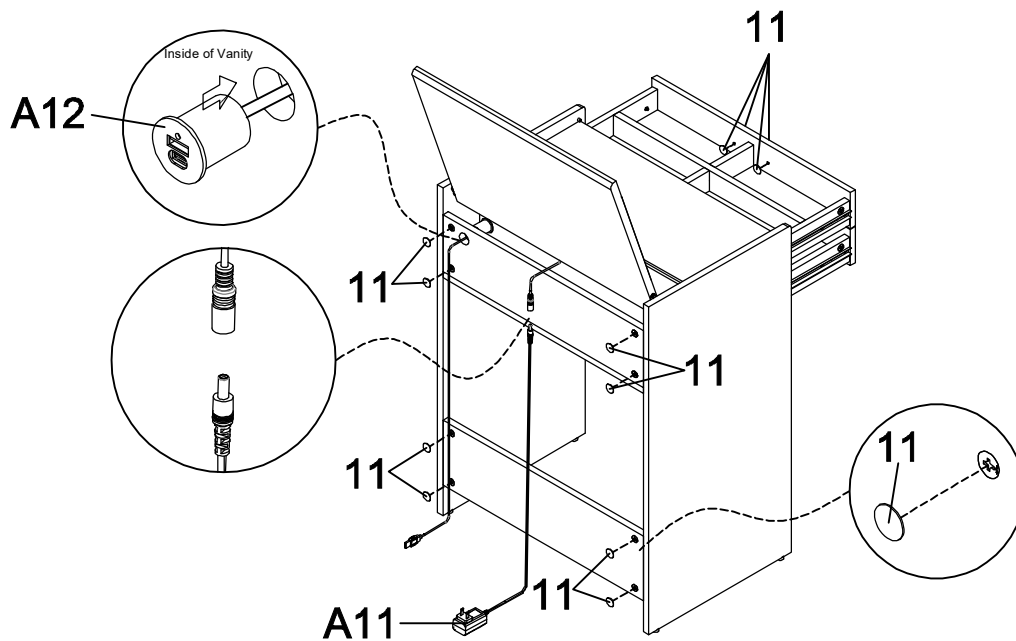

ITEM:930209
ASSEMBLY INSTRUCTIONS



STEP 16
COMPLETE

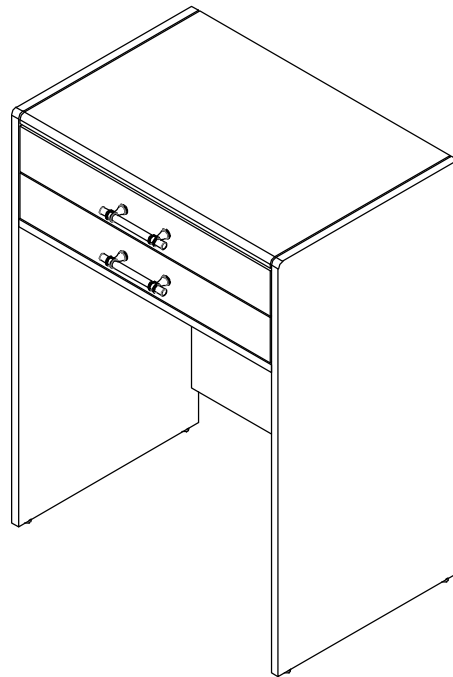

STEP 17

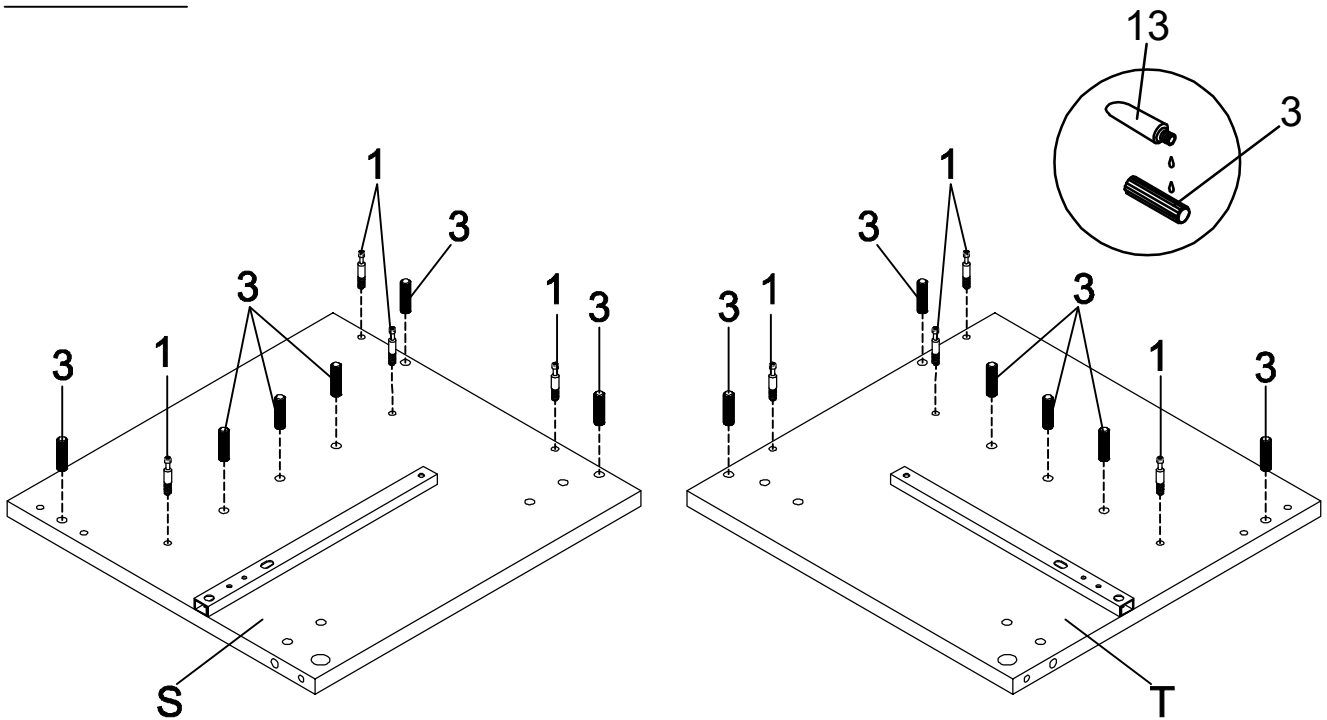

ITEM:930209
ASSEMBLY INSTRUCTIONS
STEP 18

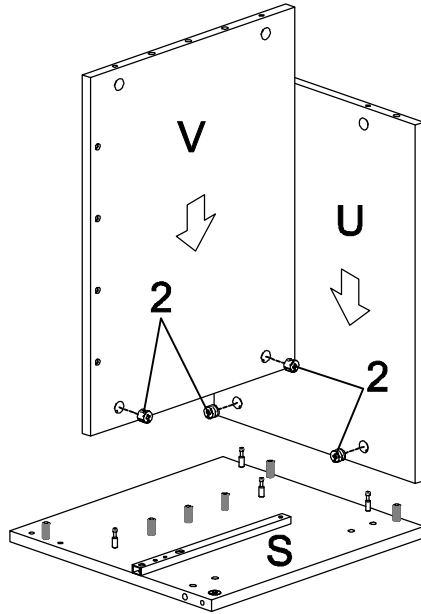

STEP 19

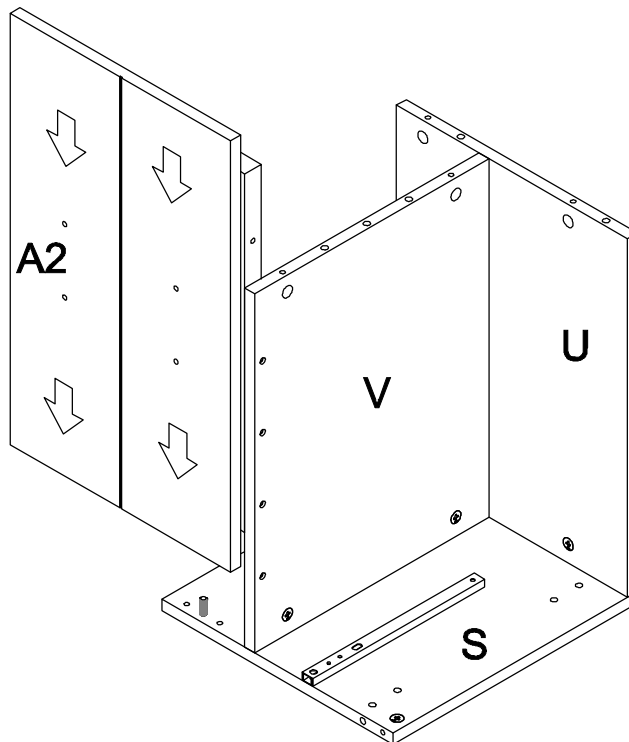

ITEM:930209
ASSEMBLY INSTRUCTIONS
STEP 20

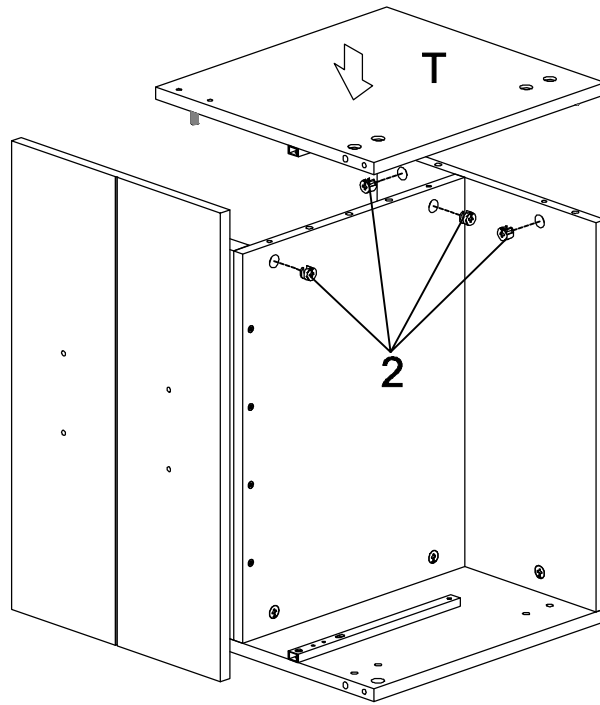

STEP 21

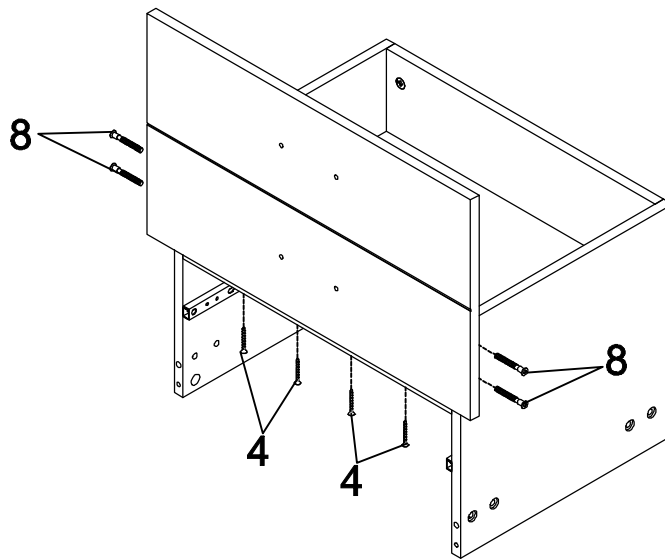

ITEM:930209
ASSEMBLY INSTRUCTIONS
STEP 22

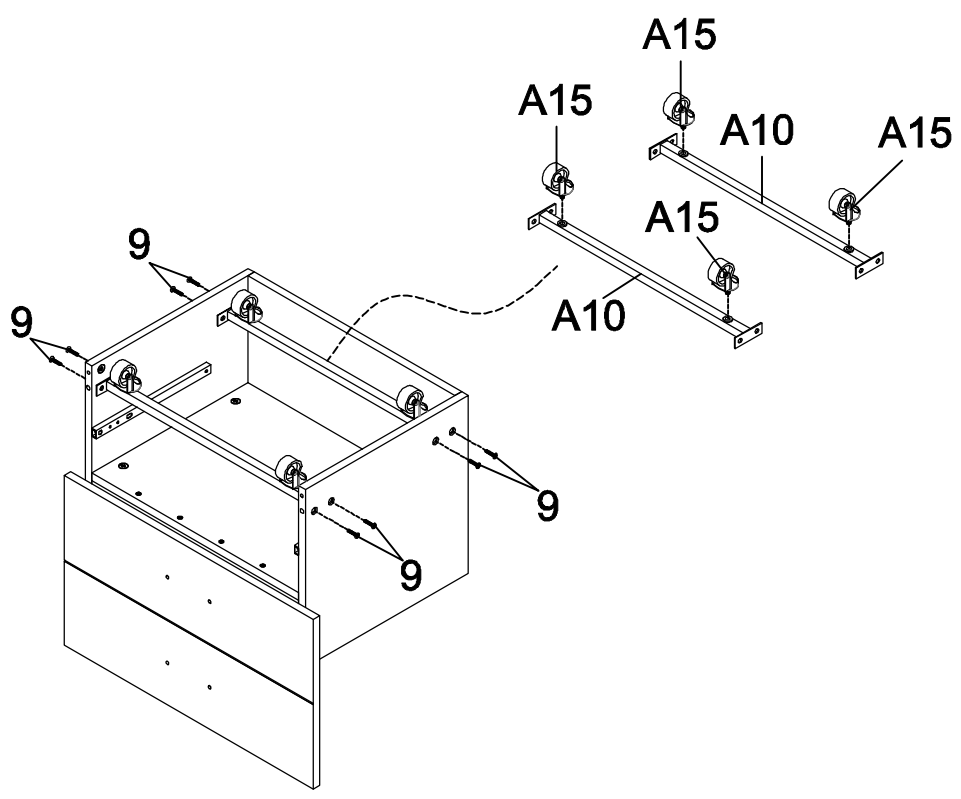

STEP 23

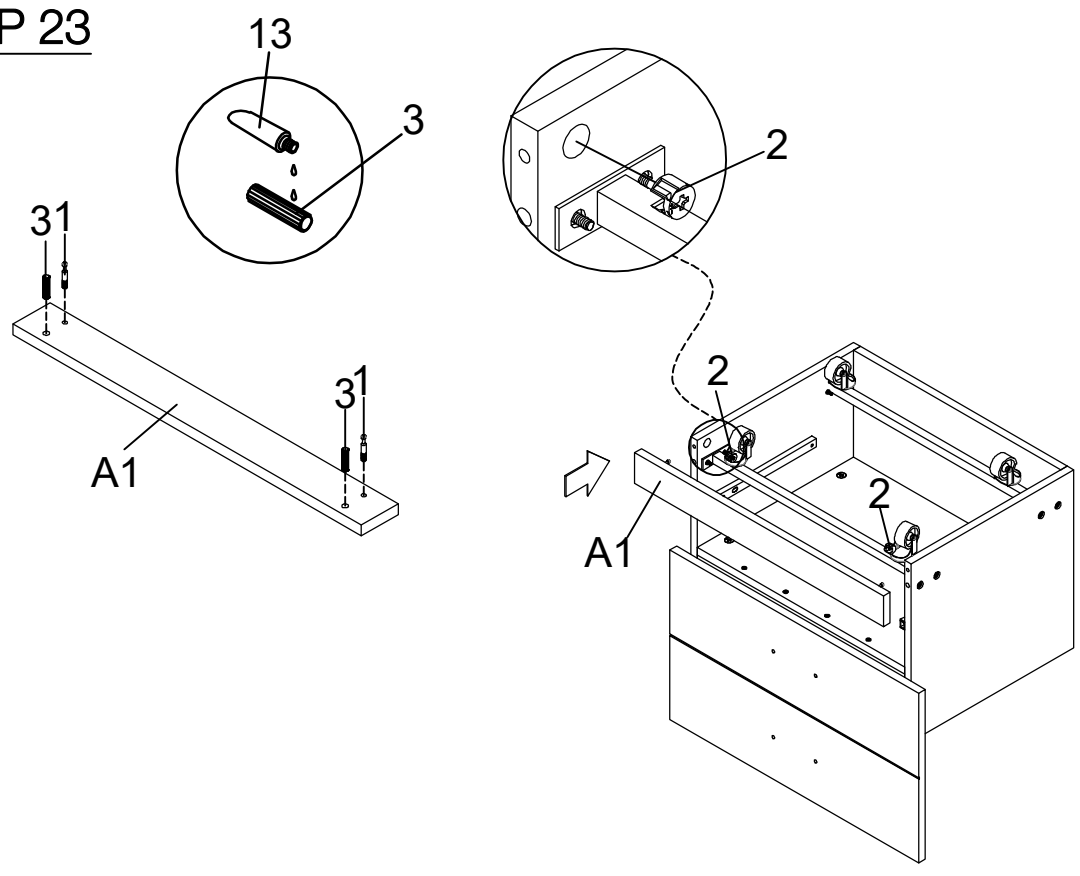

ITEM:930209
ASSEMBLY INSTRUCTIONS
STEP 24

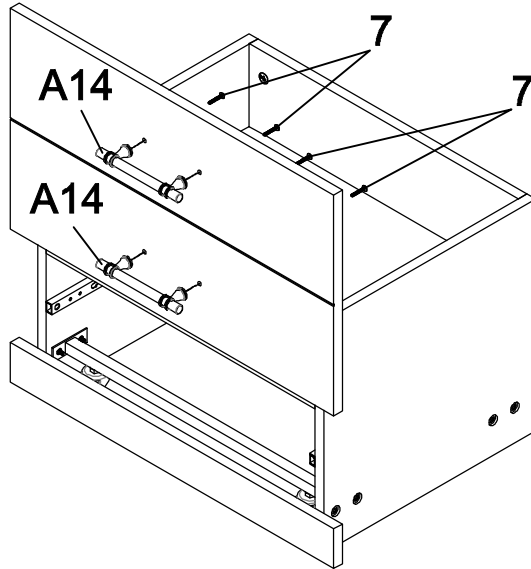

STEP 25

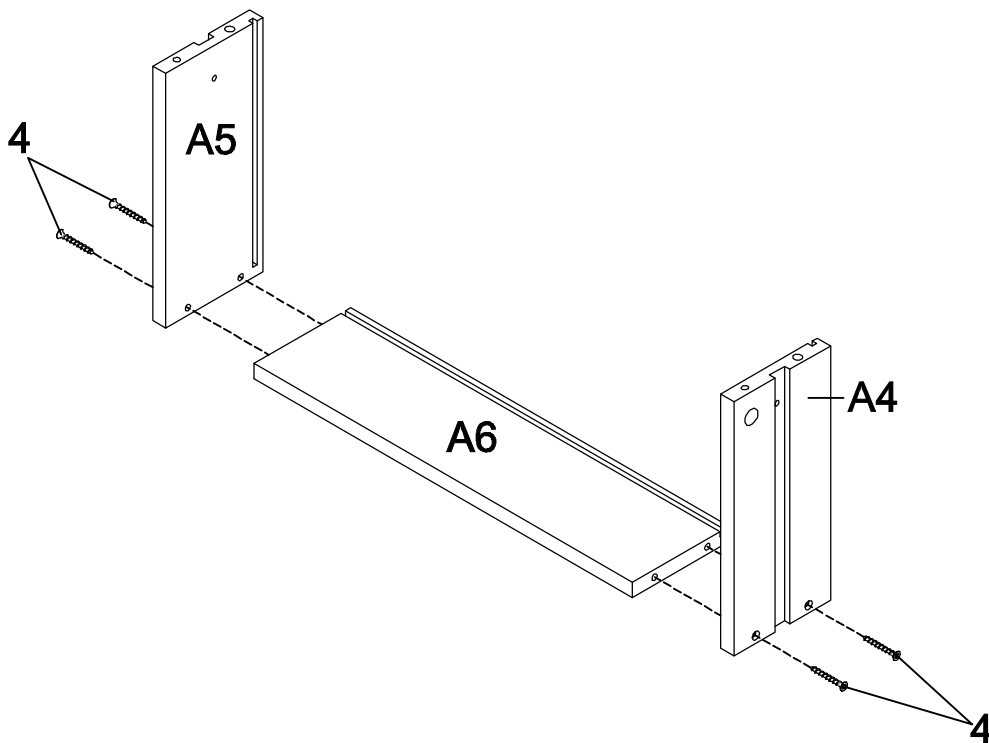

ITEM:930209
ASSEMBLY INSTRUCTIONS
STEP 26

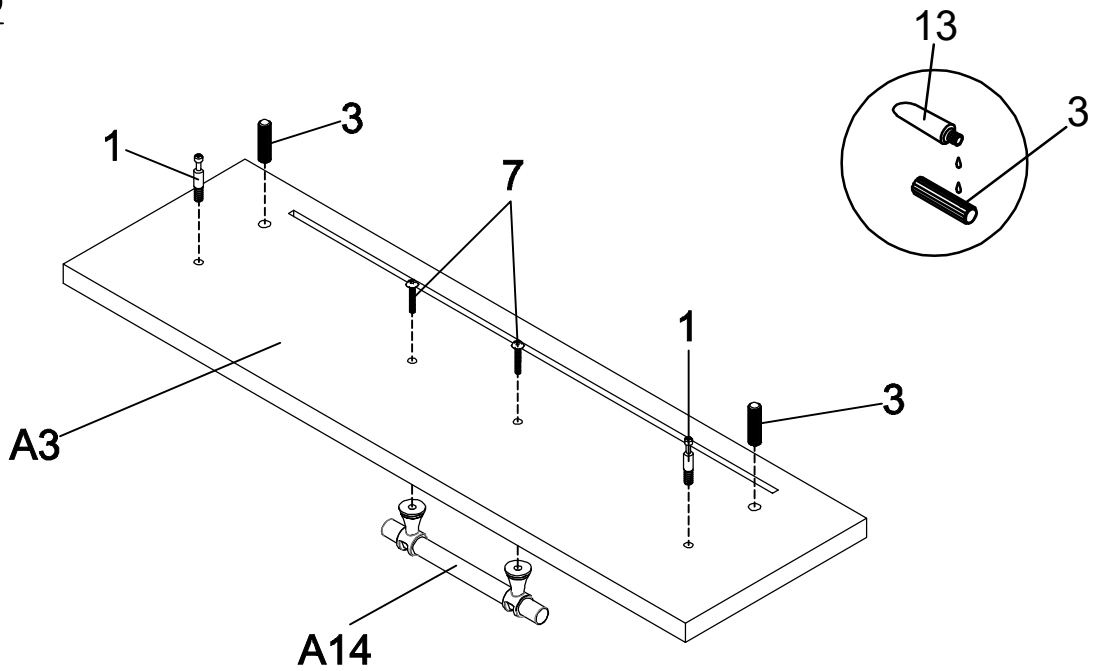

STEP 27

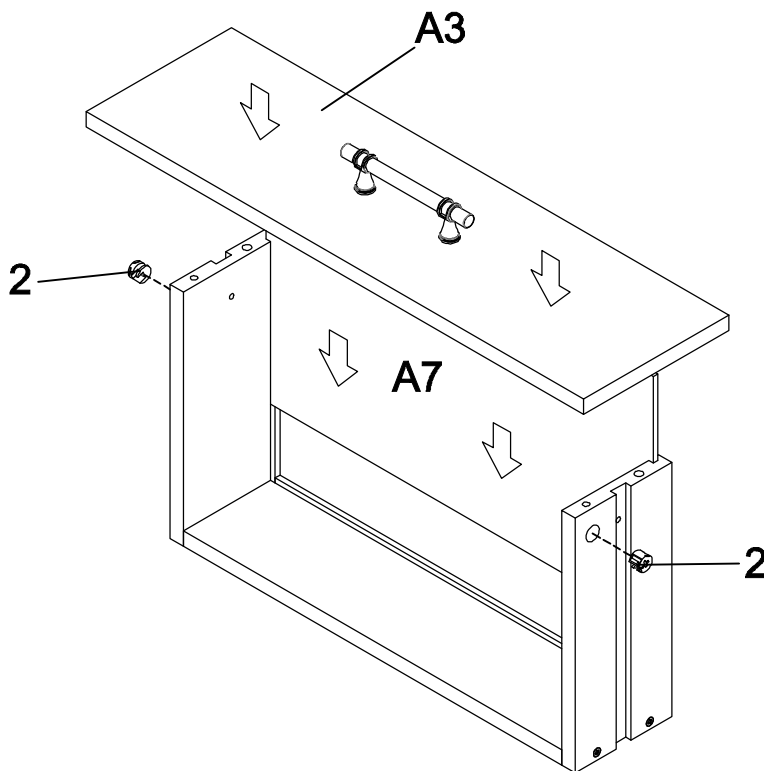

ITEM:930209
ASSEMBLY INSTRUCTIONS
STEP 28

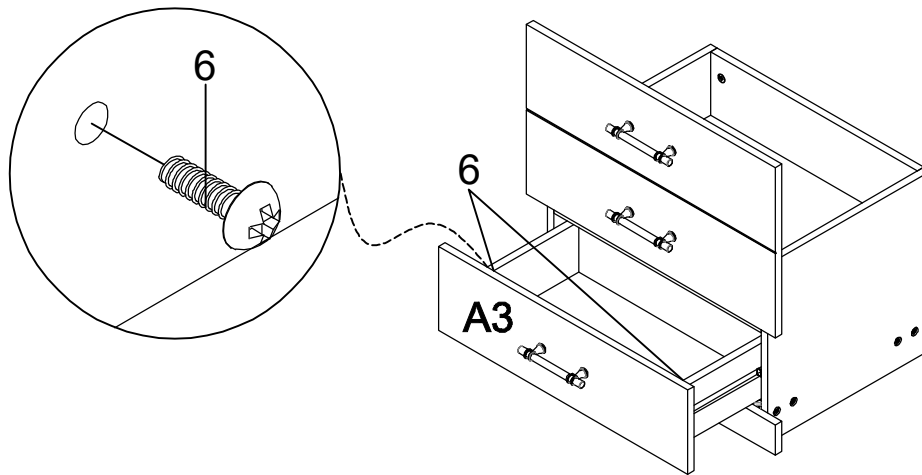

STEP 29

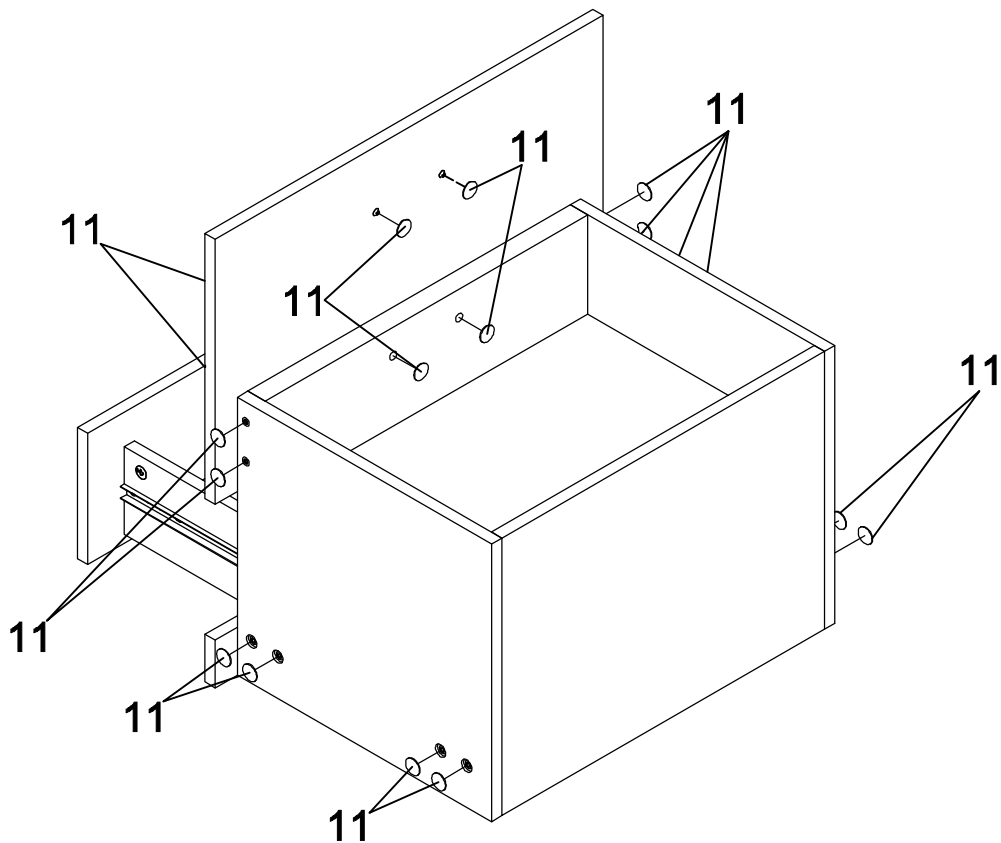

ITEM:930209
ASSEMBLY INSTRUCTIONS
STEP 30

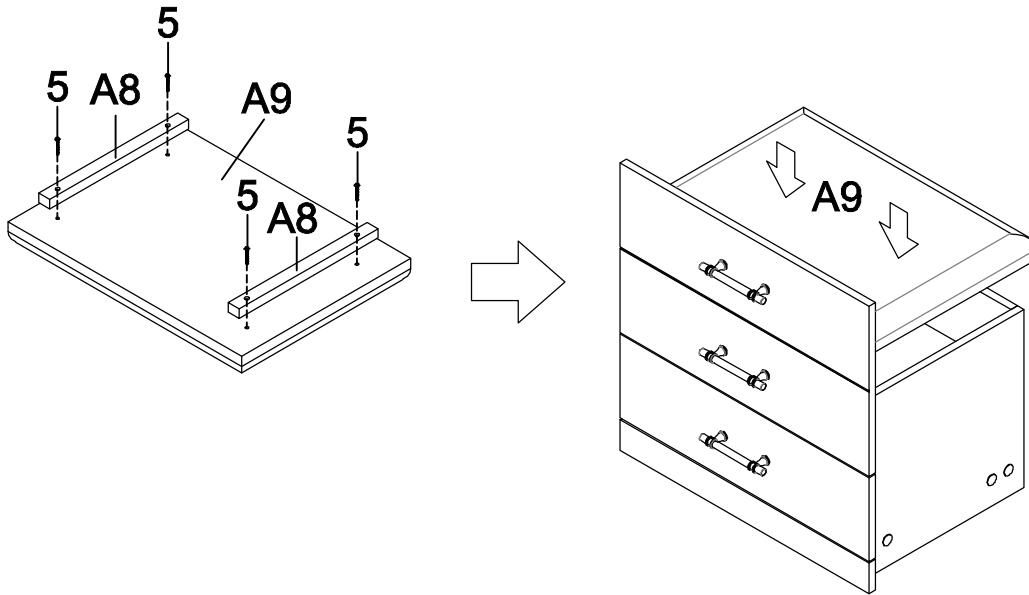

STEP 31
COMPLETE

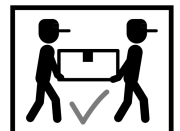
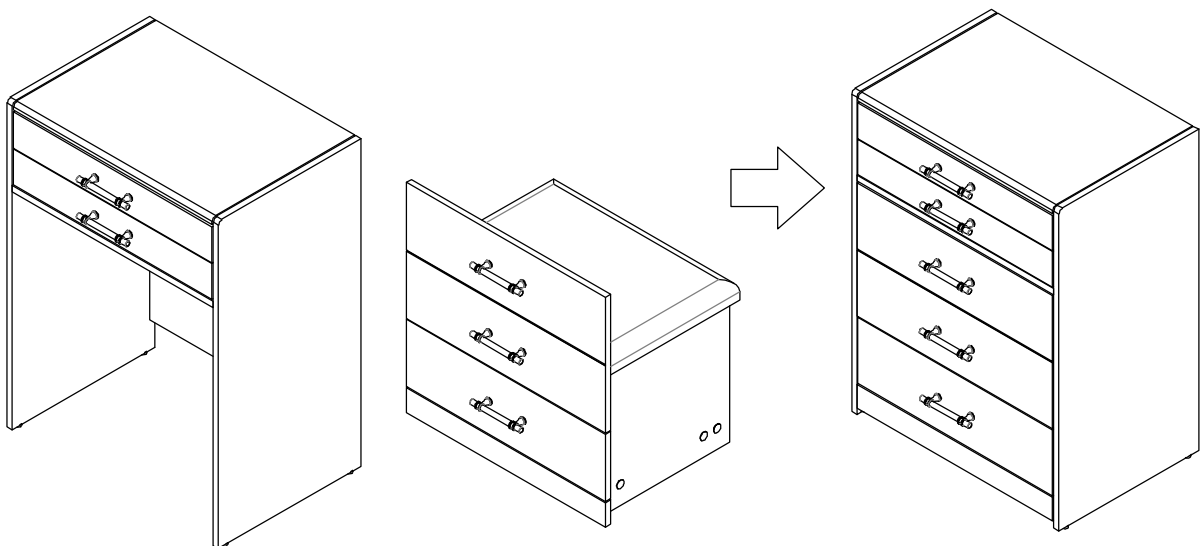

ITEM:930209 ASSEMBLY INSTRUCTIONS



Product Size : 603 X 445 X 800~1162 H (MM)
Product Size : 23.75" X 17.5" X 31.5"~45.75"

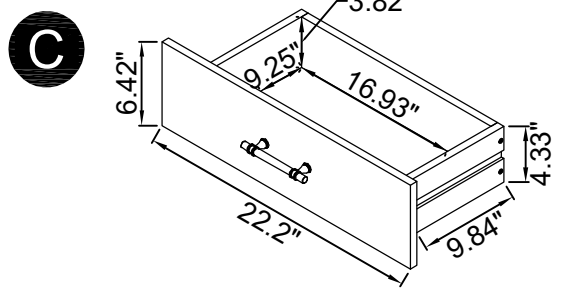
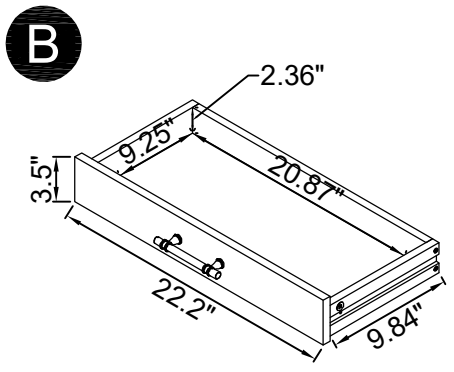
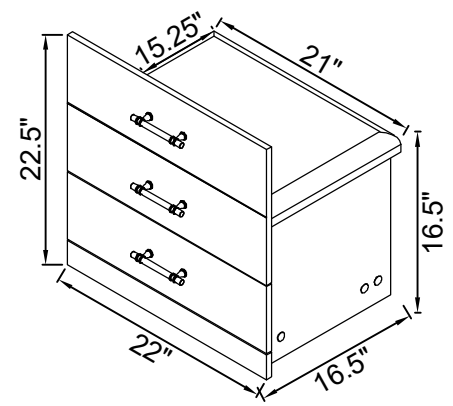
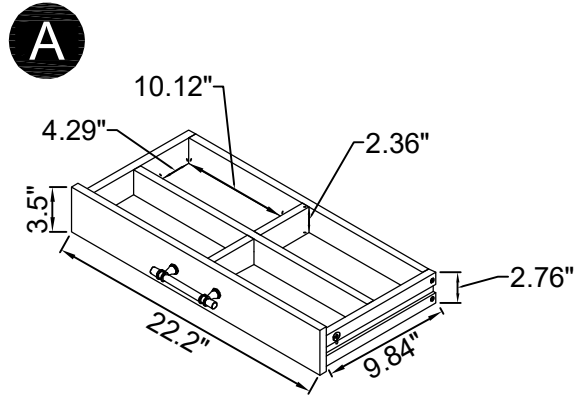
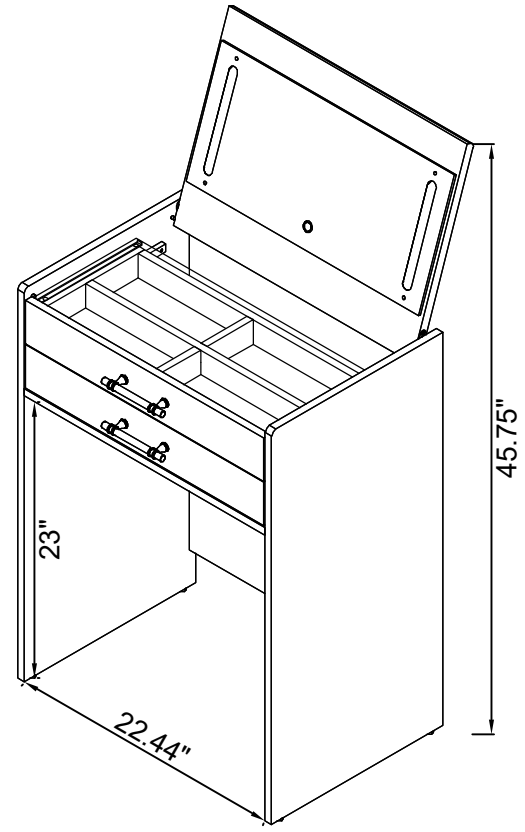
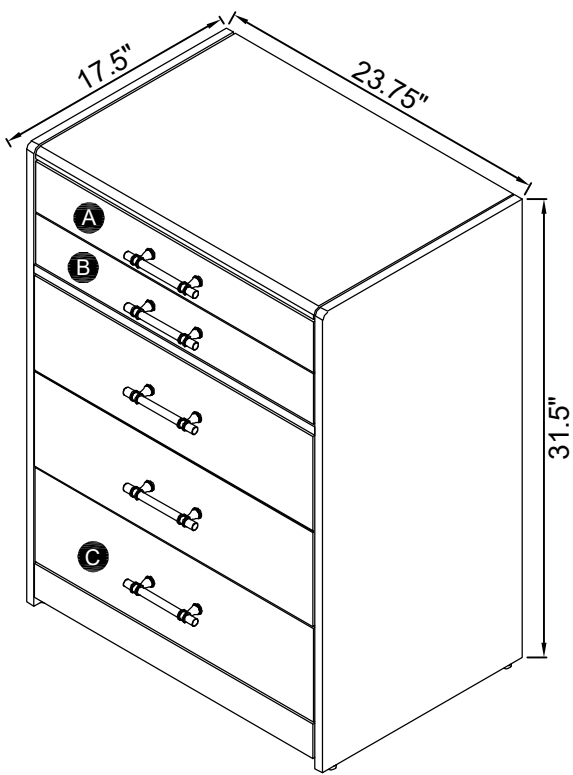

Note : Dimension tolerance $\pm 5\%$