



# ASSEMBLY INSTRUCTIONS COASTER FINE FURNITURE



*Fine Furniture for every stage of life*

508801  
**SOFA**

REVISION 0: 07/29/2024

PAGE 1 OF 5

COASTERFURNITURE.COM

ITEM: 508801

## ASSEMBLY INSTRUCTIONS

### ASSEMBLY TIPS:

1. Remove hardware from box and sort by size.
2. Please check to see that all hardware and parts are present prior to start of assembly.
3. Please follow attached instructions in the same sequence as numbered to assure fast & easy assembly.



### WARNING!

1. Don't attempt to repair or modify parts that are broken or defective. Please contact the store immediately.
2. This product is for home use only and not intended for commercial establishments.

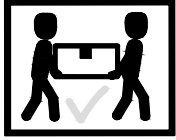

ASSEMBLY TIME

10 MINUTES



## PARTS IDENTIFICATION

A SOFA BASE

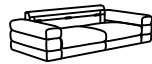

1PC

B BACK CUSHION

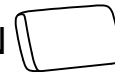

2PCS

C LEG



4PCS

D MIDDLE LEG

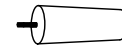

1PC

## Z HAREWARE IDENTIFICATION

1 WASHER  
(M6-SR)



8 PCS

2 BOLT  
(M6\*30-GD)



8 PCS

3 ALLEN KEY  
(M6-GD)



1 PC

ITEM: 508801

**ASSEMBLY INSTRUCTIONS**  
**STEP 1**

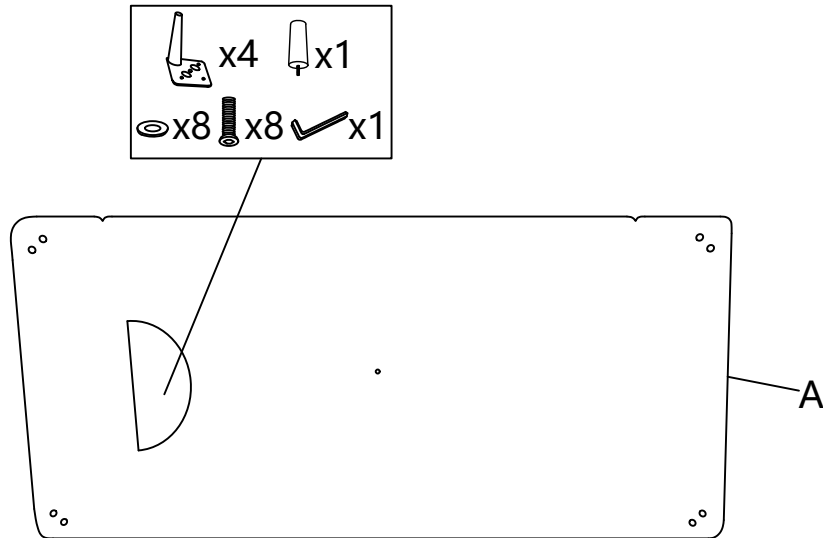

**STEP 2**

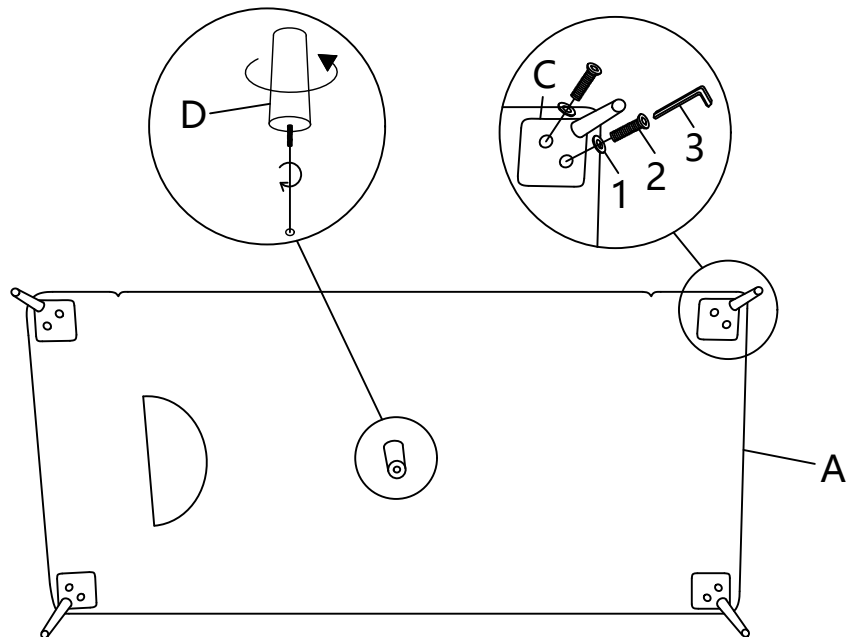

ITEM: 508801

**ASSEMBLY INSTRUCTIONS**  
**STEP 3**

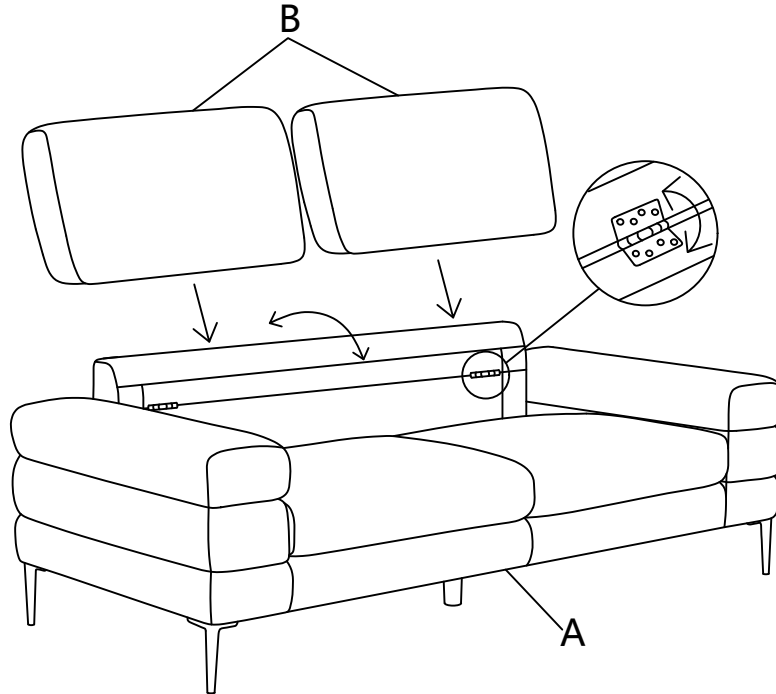

**STEP 4**

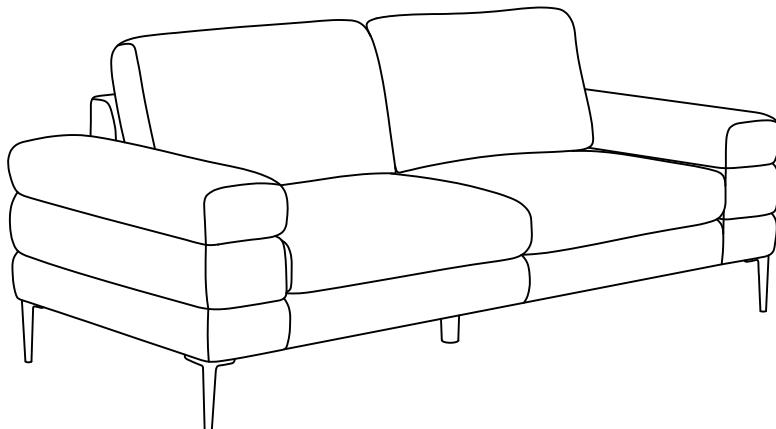

ITEM: 508801

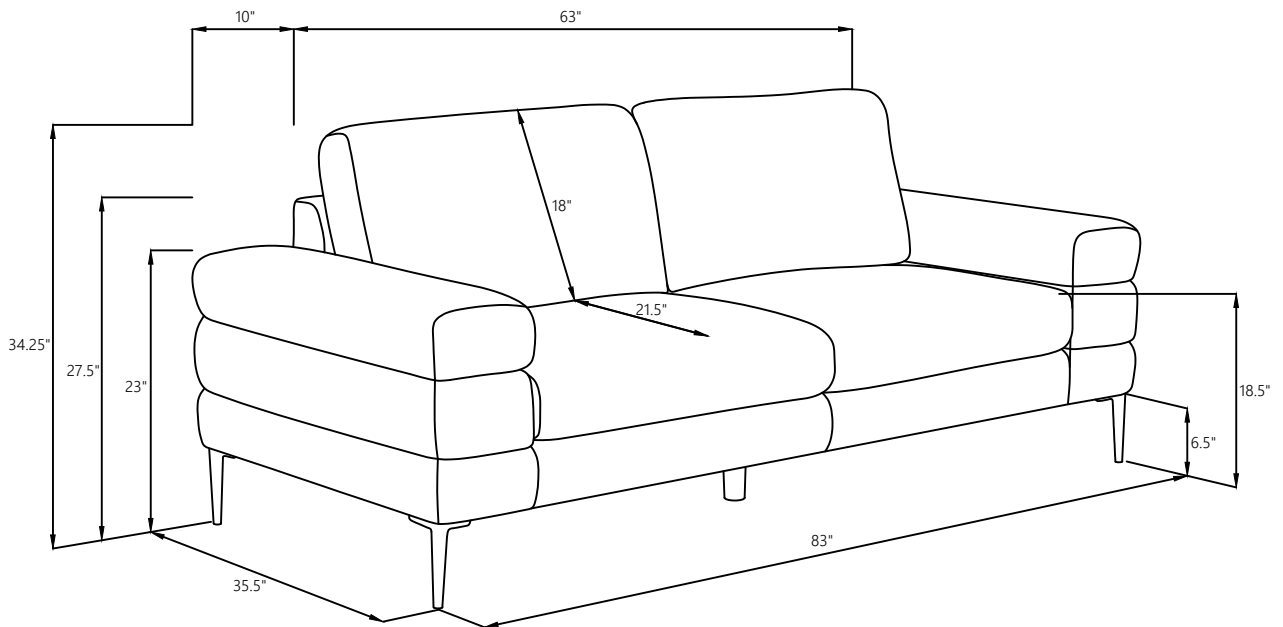

Note: Dimension tolerance  $\pm 5\%$





# ASSEMBLY INSTRUCTIONS

## COASTER FINE FURNITURE



*Fine Furniture for every stage of life*

ITEM: 508802

## ASSEMBLY INSTRUCTIONS

### ASSEMBLY TIPS:

1. Remove hardware from box and sort by size.
2. Please check to see that all hardware and parts are present prior to start of assembly.
3. Please follow attached instructions in the same sequence as numbered to assure fast & easy assembly.



### WARNING!

1. Don't attempt to repair or modify parts that are broken or defective. Please contact the store immediately.
2. This product is for home use only and not intended for commercial establishments.

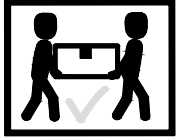

ASSEMBLY TIME

10 MINUTES



## PARTS IDENTIFICATION

A LOVESEAT BASE



1PC

B BACK CUSHION



2PCS

C LEG

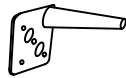

4PCS

## Z HAREWARE IDENTIFICATION

1 WASHER  
(M6-SR)



8 PCS

2 BOLT  
(M6\*30-GD)



8 PCS

3 ALLEN KEY  
(M6-GD)



1 PC

ITEM: 508802

**ASSEMBLY INSTRUCTIONS**  
**STEP 1**

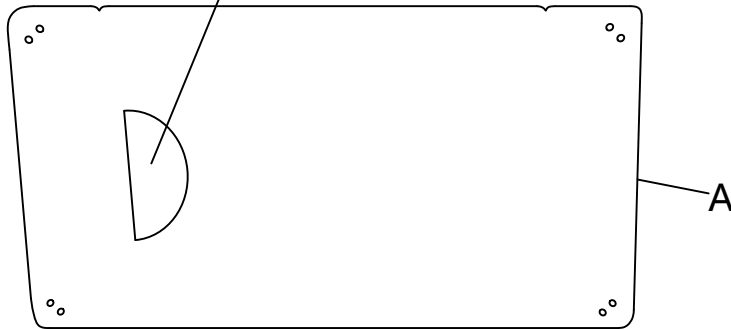
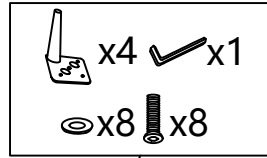

**STEP 2**

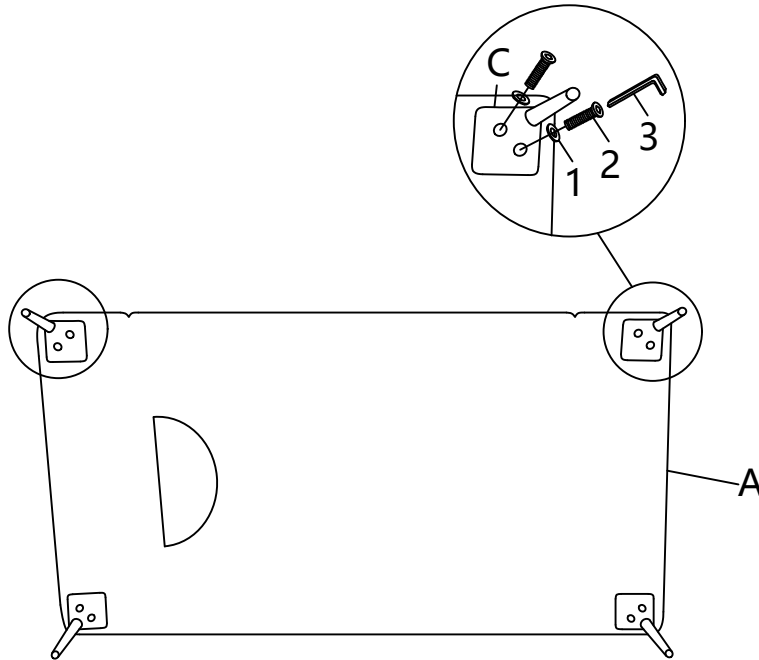



ITEM: 508802

**ASSEMBLY INSTRUCTIONS**  
**STEP 3**

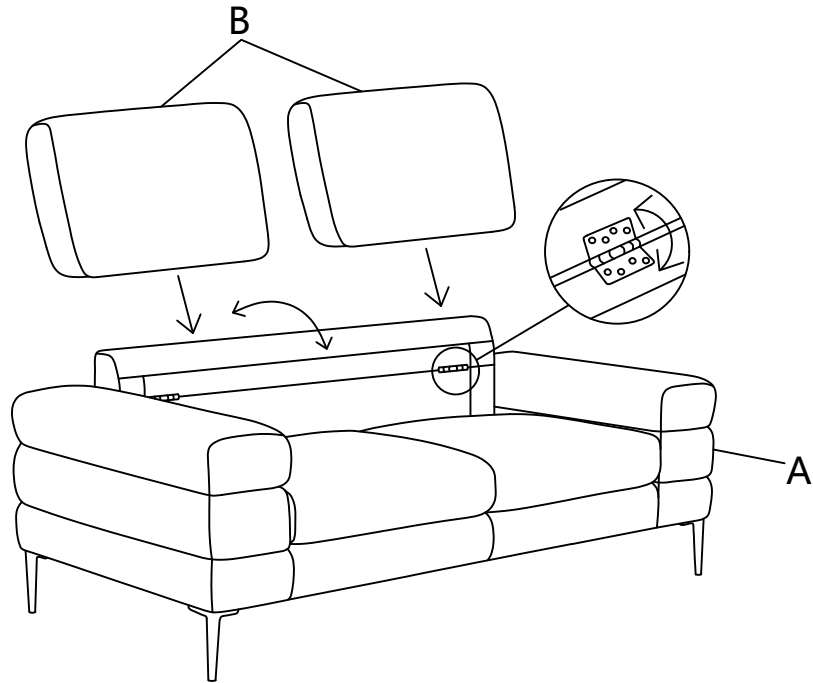

**STEP 4**

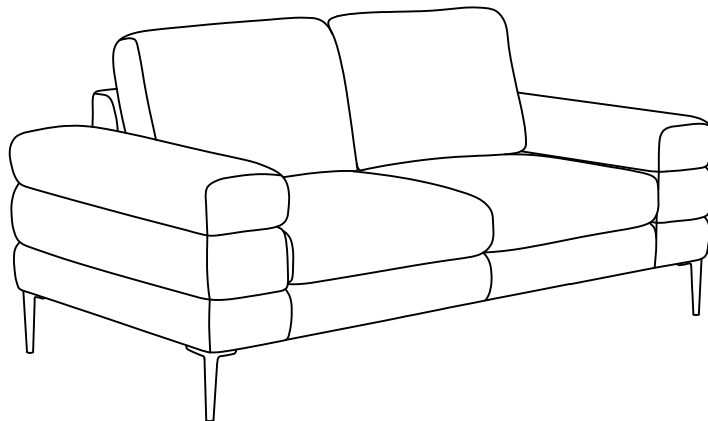

ITEM: 508802

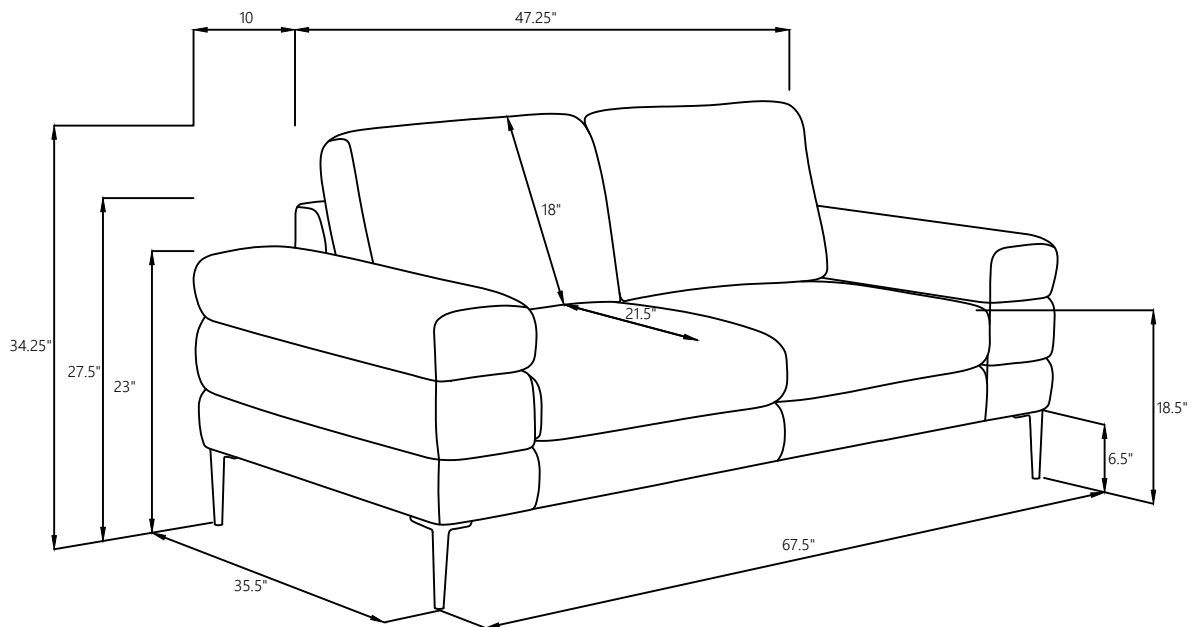

Note: Dimension tolerance  $\pm 5\%$





# ASSEMBLY INSTRUCTIONS COASTER FINE FURNITURE



*Fine Furniture for every stage of life*

508803  
**CHAIR**

ITEM: 508803



## ASSEMBLY INSTRUCTIONS

### ASSEMBLY TIPS:

1. Remove hardware from box and sort by size.
2. Please check to see that all hardware and parts are present prior to start of assembly.
3. Please follow attached instructions in the same sequence as numbered to assure fast & easy assembly.



### WARNING!

1. Don't attempt to repair or modify parts that are broken or defective. Please contact the store immediately.
2. This product is for home use only and not intended for commercial establishments.

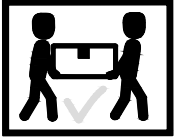

ASSEMBLY TIME

10 MINUTES

## PARTS IDENTIFICATION

A CHAIR BASE



1PC

B BACK CUSHION



1PC

C LEG

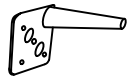

4PCS

## Z HAREWARE IDENTIFICATION

1 WASHER  
(M6-SR)



8 PCS

2 BOLT  
(M6\*30-GD)



8 PCS

3 ALLEN KEY  
(M6-GD)



1 PC

ITEM: 508803

**ASSEMBLY INSTRUCTIONS**  
**STEP 1**

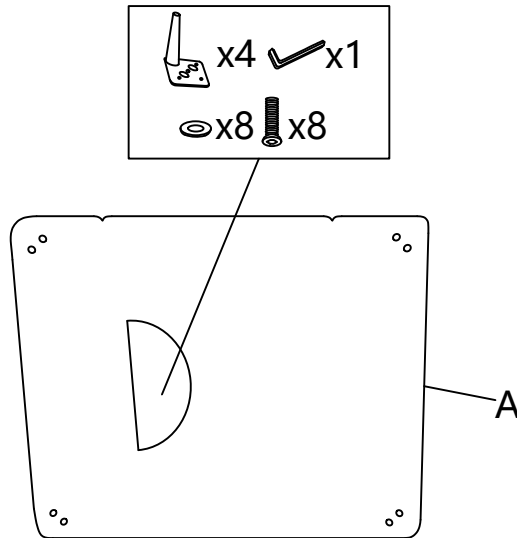

**STEP 2**

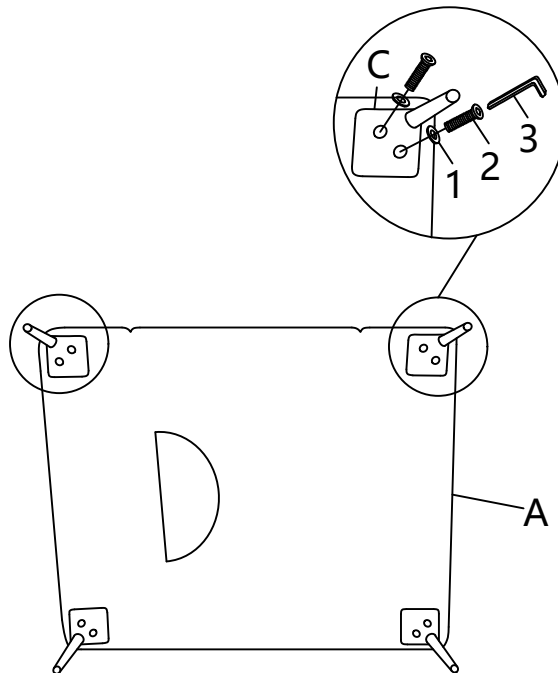

ITEM: 508803

**ASSEMBLY INSTRUCTIONS**  
**STEP 3**

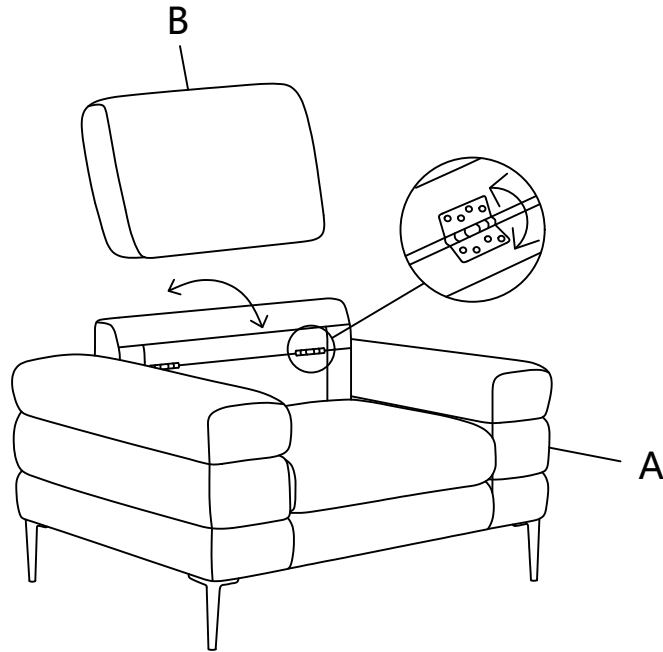

**STEP 4**

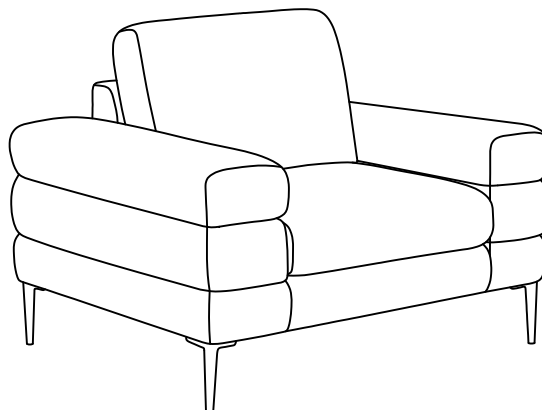

ITEM: 508803

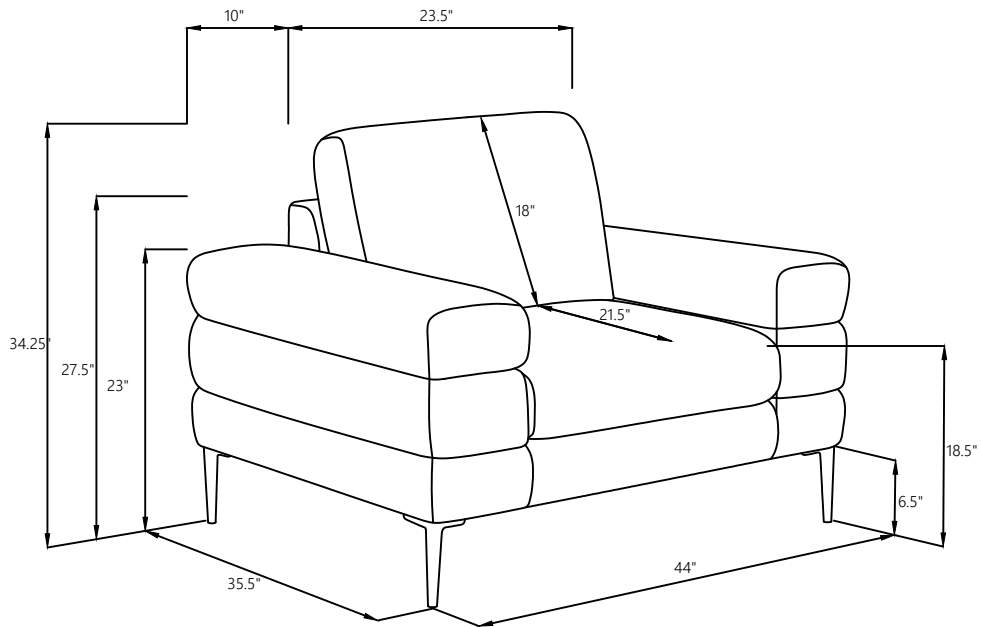

Note: Dimension tolerance  $\pm 5\%$

