



ASSEMBLY INSTRUCTIONS COASTER FINE FURNITURE



Fine Furniture for every stage of life

204393
Dresser

REVISION 0 : 10/30/2015
REVISION 1 : 01/21/2020
REVISION 2 : 09/14/2024

PAGE 1 OF 6

COASTERFURNITURE.COM

ITEM: 204393



ASSEMBLY INSTRUCTIONS

ASSEMBLY TIPS:

- 1 . Remove hardware from box and sort by size.
- 2 . Please check to see that all hardware and parts are present prior to start of assembly.
- 3 . Please follow attached instructions in the same sequence as numbered to assure fast & easy assembly.



WARNING !

- 1 . Don't attempt to repair or modify parts that are broken or defective. Please contact the store immediately.
- 2 . This product is for home use only and not intended for commercial establishment.

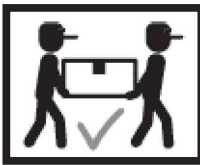

ASSEMBLY TIME

20 MINUTES

PARTS IDENTIFICATION

A DRESSER

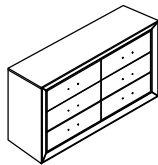

1PC

D RIGHT BACK LEG
(WITH BR LABEL)

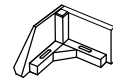

1PC

B RIGHT FRONT LEG
(WITH FR LABEL)

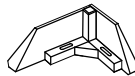

1PC

E LEFT BACK LEG
(WITH BL LABEL)

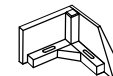

1PC

C LEFT FRONT LEG
(WITH FL LABEL)

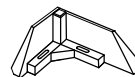

1PC

F SUPPORT LEG

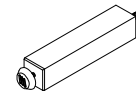

1PC

HARDWARE IDENTIFICATION

1 BOLT
(M6 x30mm - BLK)



8PCS

3 FLAT WASHER
(1/4" x20mm - BLK)



8PCS

2 LOCK WASHER
(1/4" - BLK)



8PCS

4 ALLEN WRENCH
(M4 x 65mm - BLK)



1PC

NOTE:

Philips head screw driver in the assembly process ; however, manufacturer does not provide the item

ITEM: **204393**
ASSEMBLY INSTRUCTIONS



STEP 1

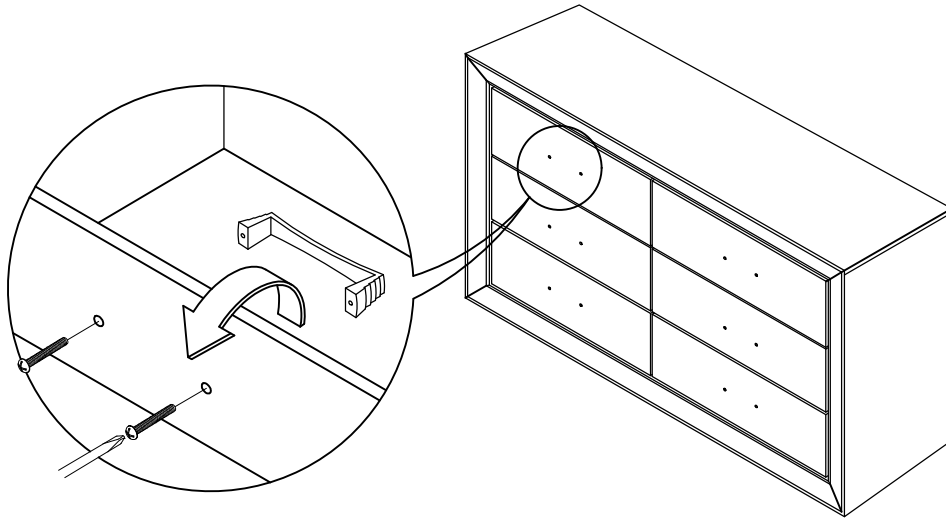

STEP 2

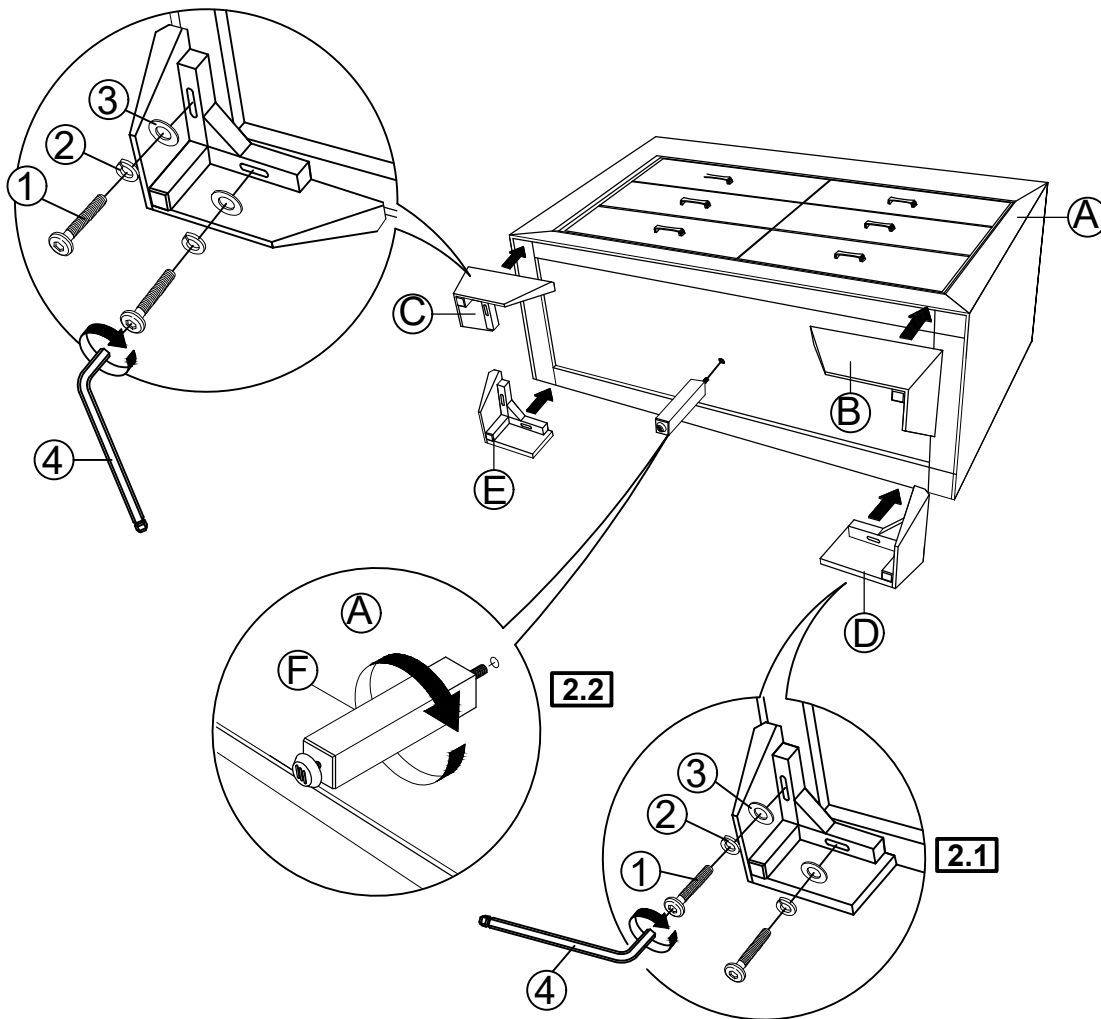

ITEM: **204393**
ASSEMBLY INSTRUCTIONS



STEP 3
COMPLETE

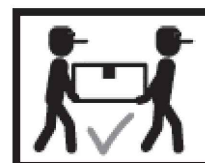
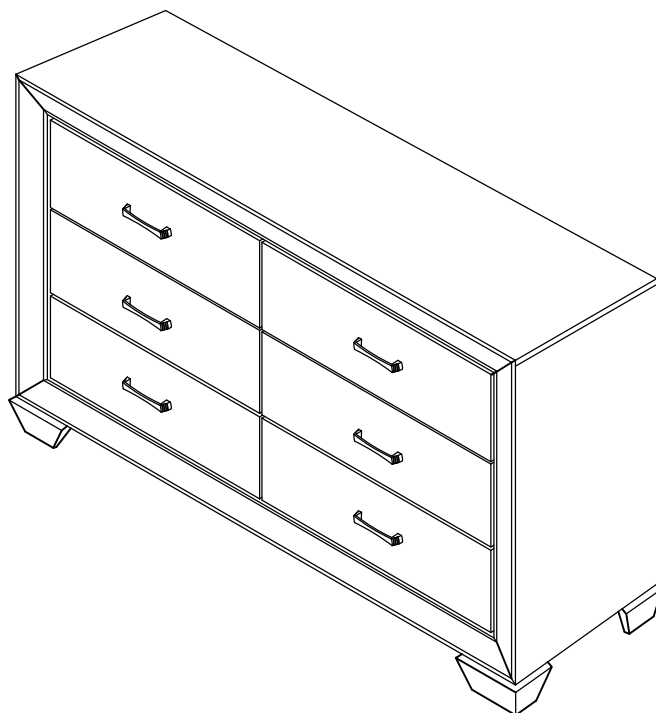

ITEM: **204393**

ANTI-TIPPING INSTALLATION INSTRUCTIONS

FURNITURE TIPPING RESTRAINT



WARNING

Injury may result from tipping furniture.
This restraint may protect against tipping furniture.
Do not allow children to climb on furniture.
This restraint is not a substitute for proper adult supervision.
Failure to detach this restraint before moving the furniture may result in injury and damage.

This restraint must be screwed to a wood stud on the wall, using the long screw provided.

STEP 1

Secure the bracket to the back top of the unit, using the short screw provided, as shown in the drawing.

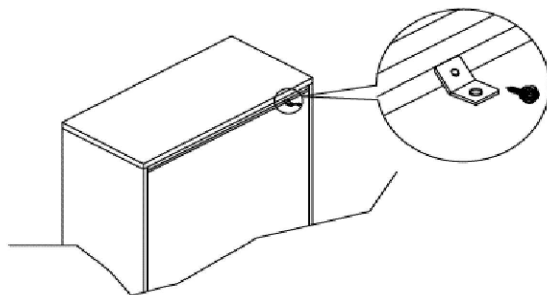

STEP 2

Locate the wood stud on the wall and secure the other bracket 2 inches below the back of the unit, using the long screw.

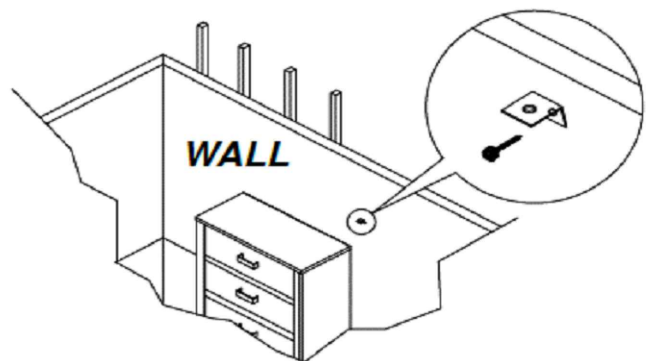

STEP 3

Place the furniture into position so both mounting brackets are vertically in line. Lace the threaded end of the restraint strap through the hole in each mounting bracket. Bring both ends together and rotate the thumb nut onto the threaded end until tight. Ensure that the restraint strap is securely laced and locked.

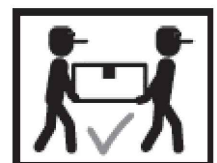
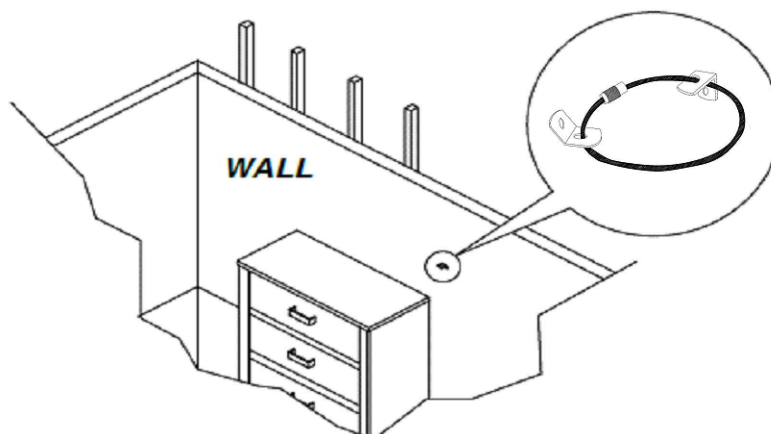

ITEM: **204393**



Inner Size Of Drawer : 23.25"W X 12.75"D X 5.00"H X 0.25"T

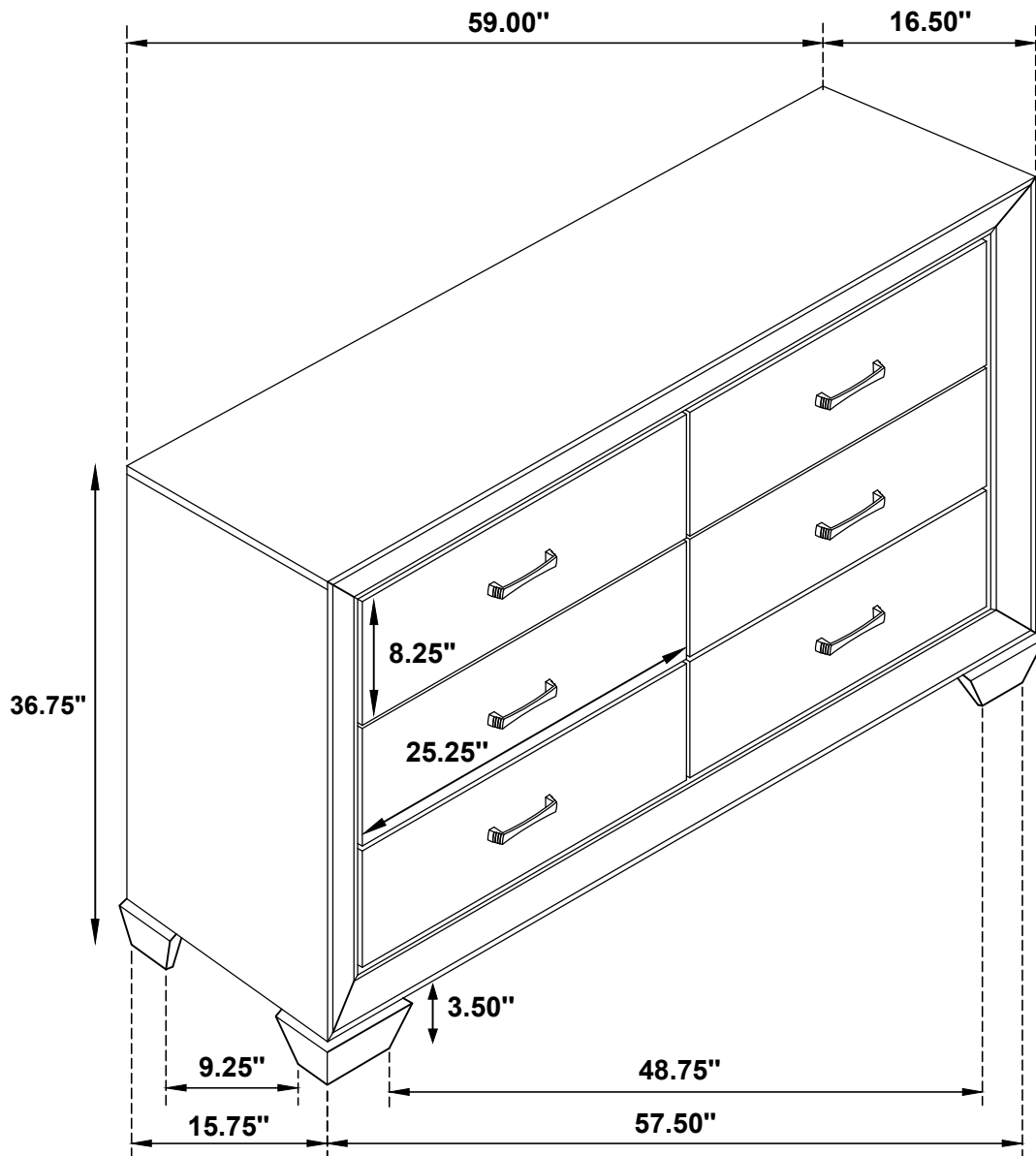

Note : Dimension tolerance $\pm 5\%$