

ASSEMBLY INSTRUCTIONS
COASTER FINE FURNITURE



Fine Furniture for every stage of life

710547
End Table

ITEM: **710547**



ASSEMBLY INSTRUCTIONS

ASSEMBLY TIPS:

1. Remove hardware from box and sort by size.
2. Please check to see that all hardware and parts are present prior to start of assembly.
3. Please follow attached instructions in the same sequence as numbered to assure fast & easy assembly.



WARNING!

1. Don't attempt to repair or modify parts that are broken or defective. Please contact the store immediately.
2. This product is for home use only and not intended for commercial establishments.



ASSEMBLY TIME

15 MINUTES

PARTS IDENTIFICATION

A TOP

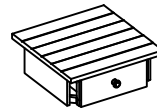

1PC

B LEG

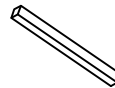

4PCS

C BOTTOM SHELF

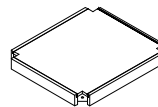

1PC

HARDWARE IDENTIFICATION

1 BOLT
(Ø1/4" x 2-1/4" - BLK)



12PCS

2 LOCK WASHER
(1/4 x 16mm - BLK)



12PCS

3 FLAT WASHER
(Ø1/4" - BLK)



12PCS

4 ALLEN WRENCH
(4mm - BLK)

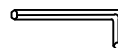

1PC

ITEM: **710547**

ASSEMBLY INSTRUCTIONS



STEP 1

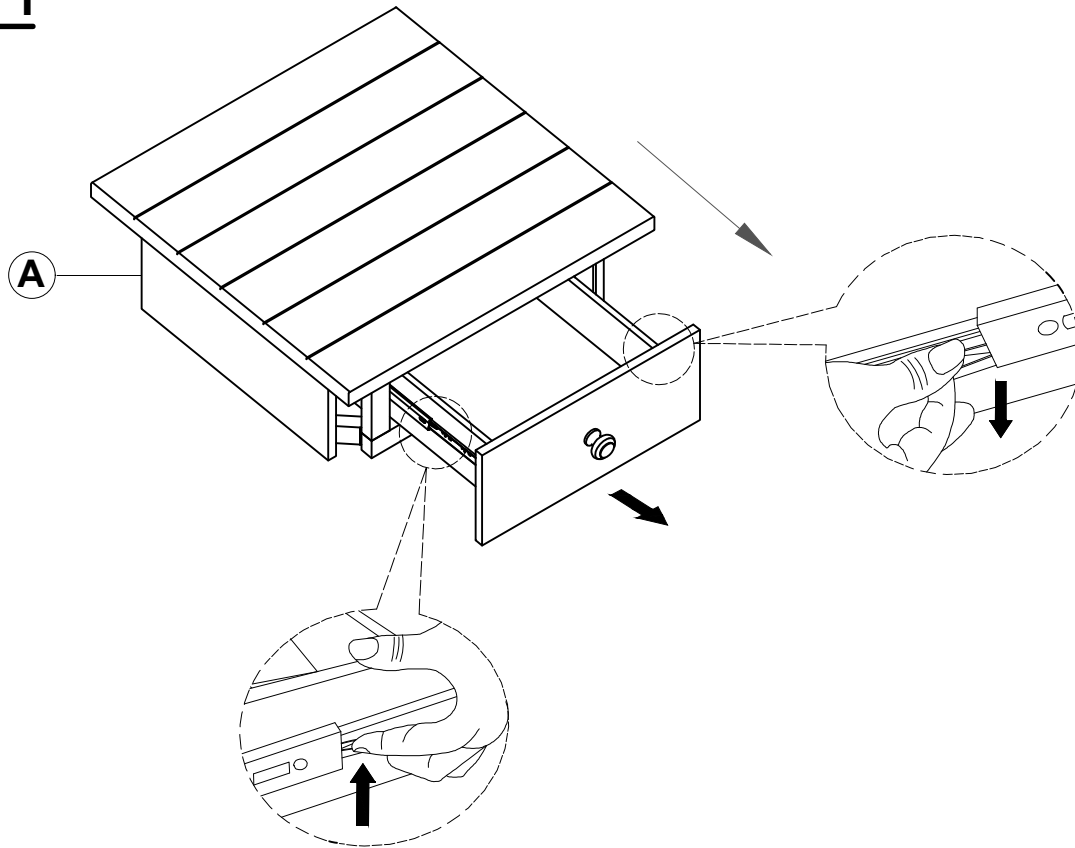

STEP 2

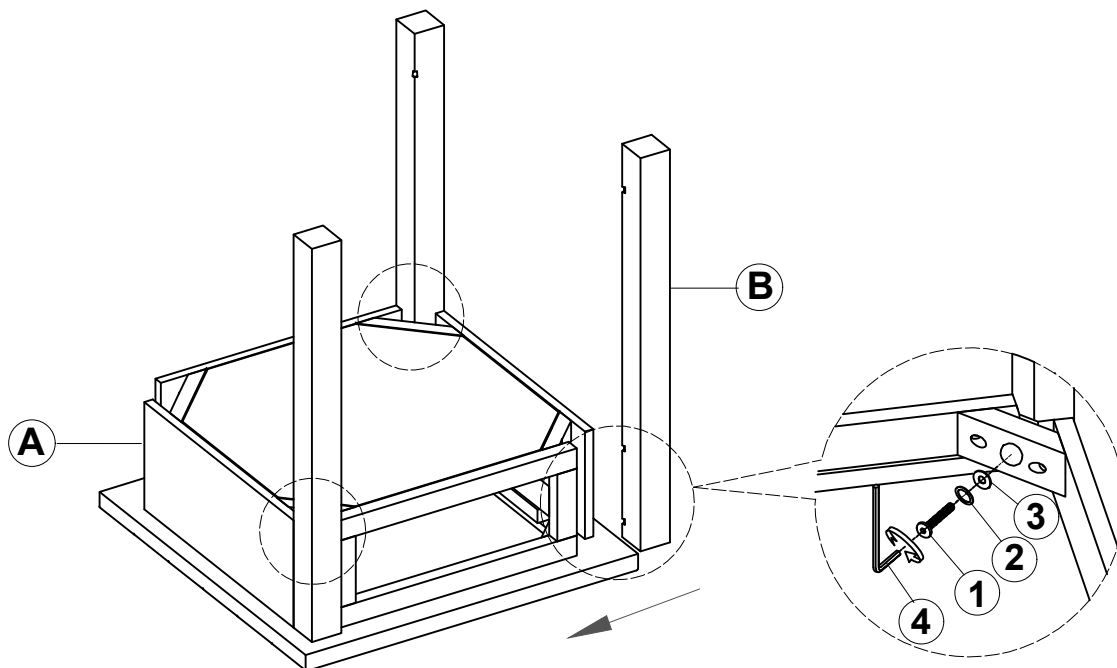

ITEM: **710547**
ASSEMBLY INSTRUCTIONS

STEP 3

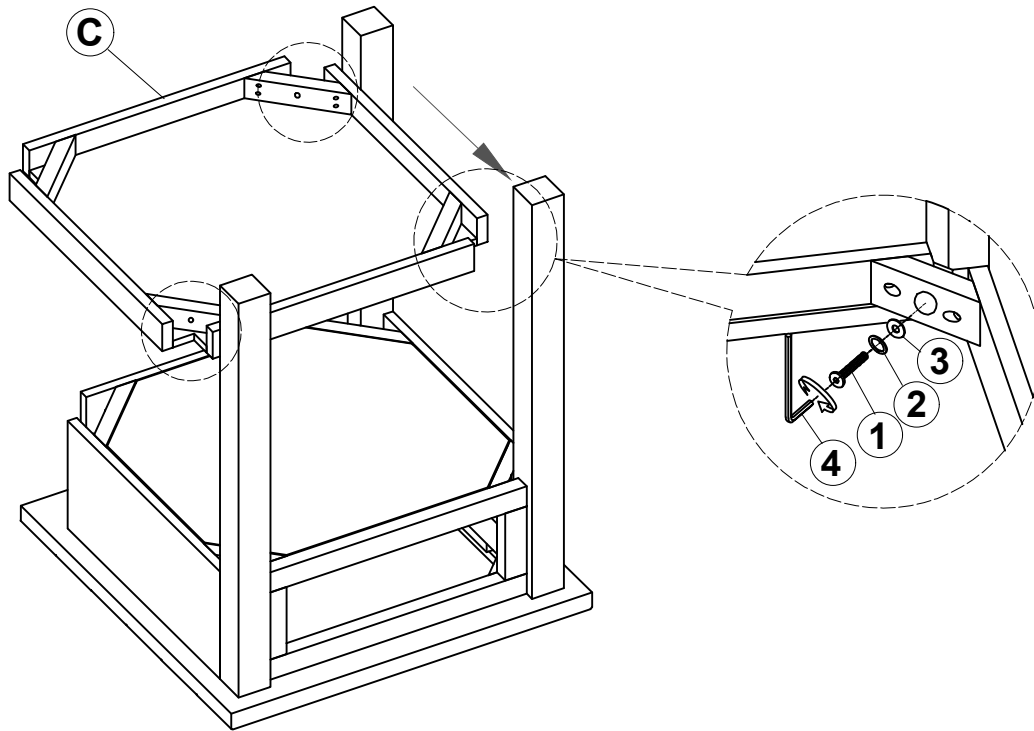

STEP 4

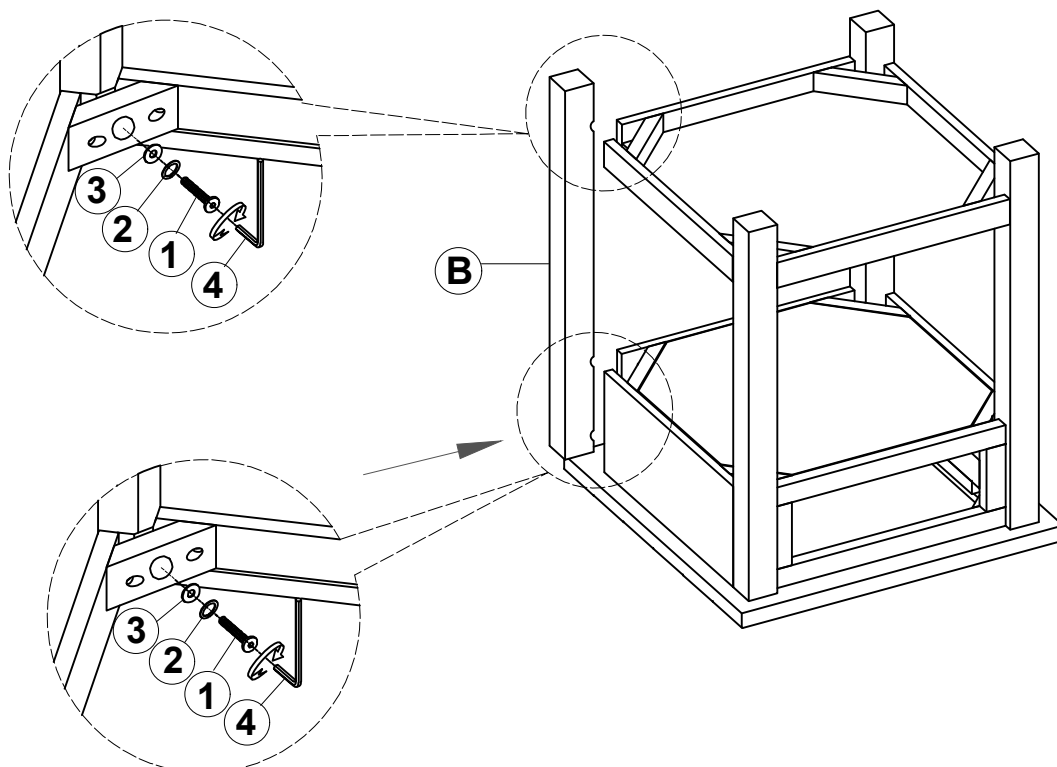

ITEM: **710547**

ASSEMBLY INSTRUCTIONS



STEP 5

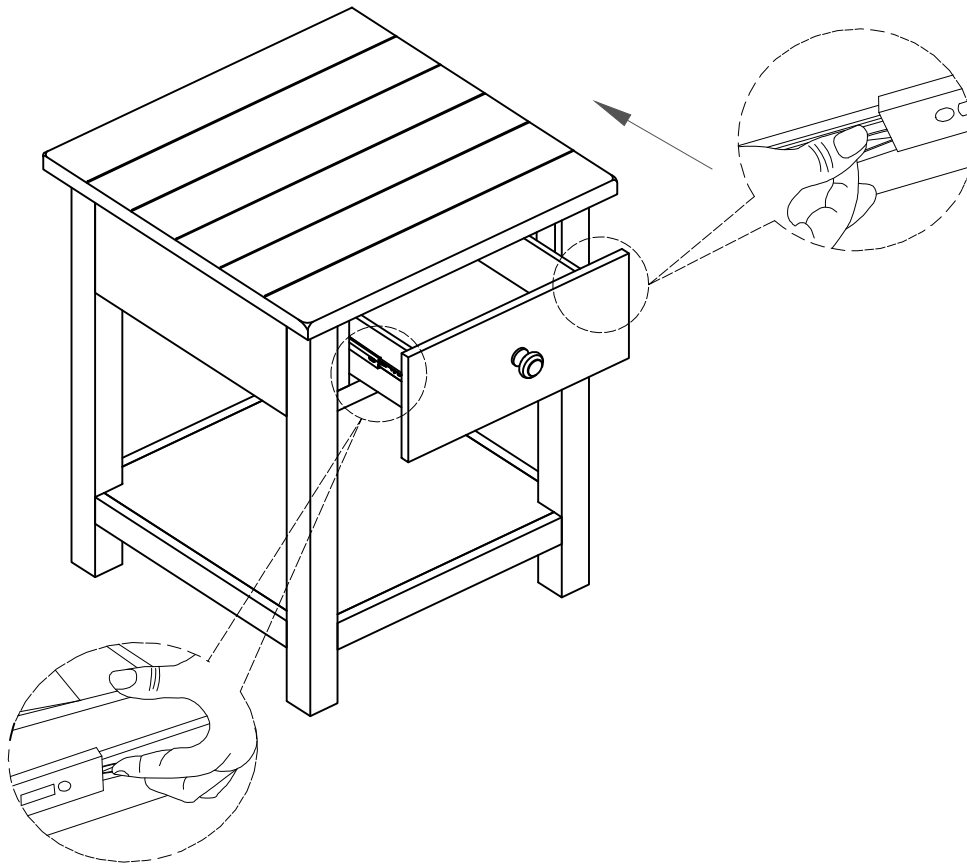

STEP 6
COMPLETE

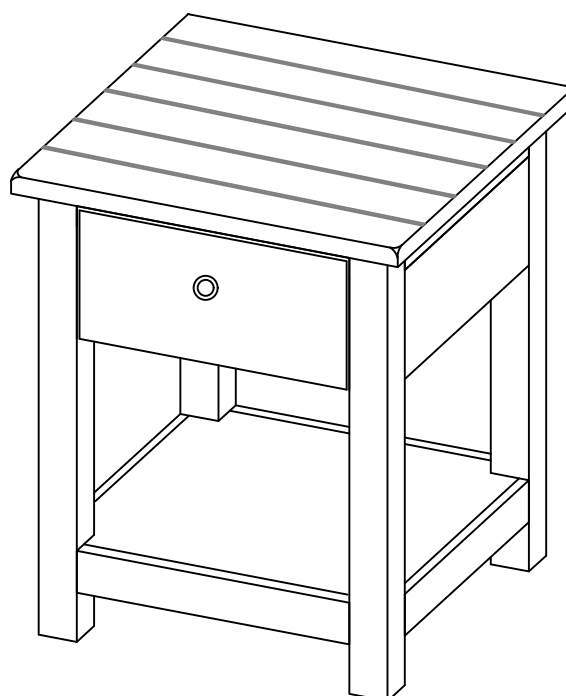

ITEM:710547



Inner Size of Drawer : 10.50"W x 13.50"D X 2.75"H X 0.25"T

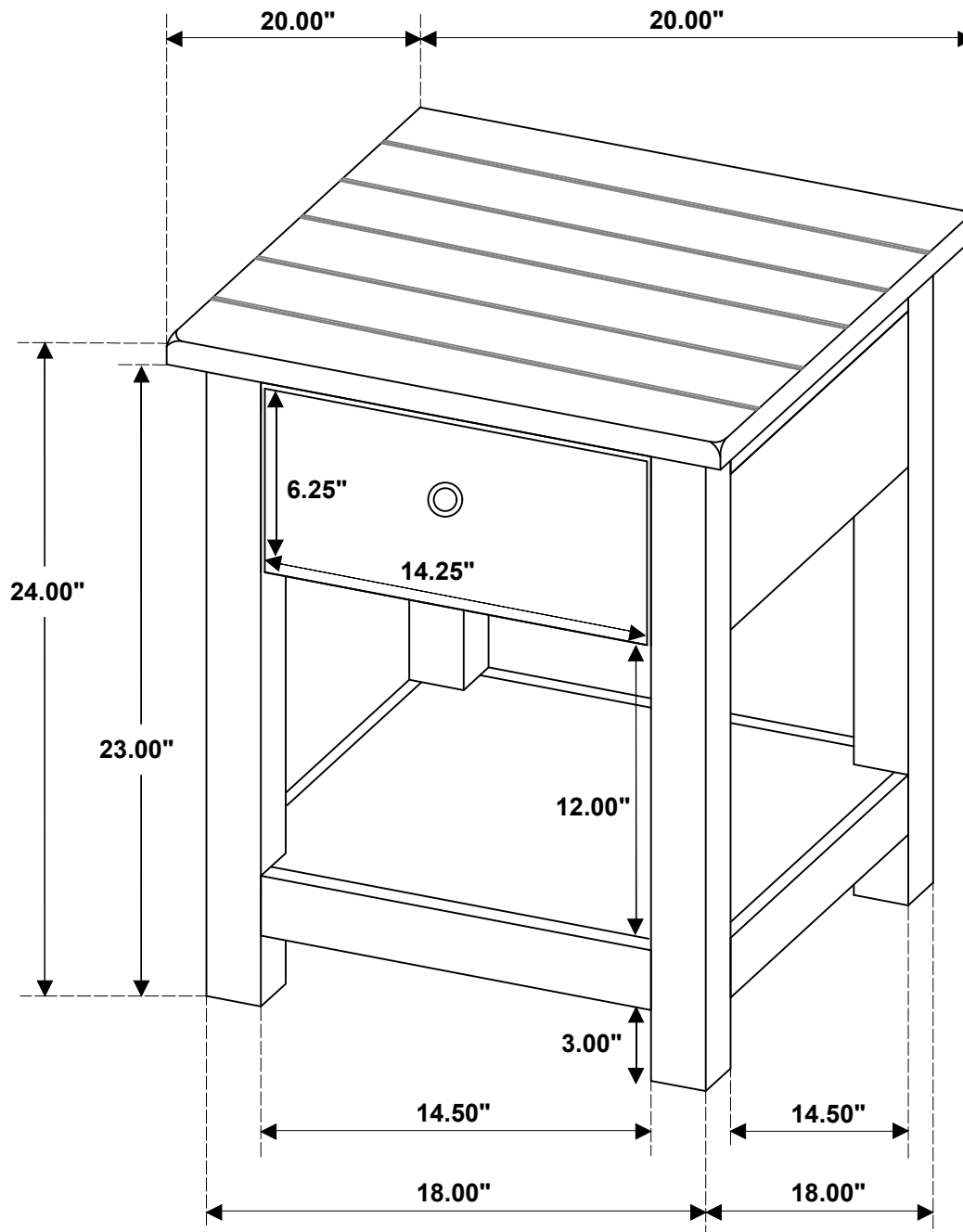

Note : Dimension tolerance $\pm 5\%$