

**ASSEMBLY INSTRUCTIONS**  
**COASTER FINE FURNITURE**



*Fine Furniture for every stage of life*

**707726**  
**MEDIA TOWER**

# ITEM: 707726



## ASSEMBLY INSTRUCTIONS

### ASSEMBLY TIPS:

1. Remove hardware from box and sort by size.
2. Please check to see that all hardware and parts are present prior to start of assembly.
3. Please follow attached instructions in the same sequence as numbered to assure fast & easy assembly.



### WARNING!

1. Don't attempt to repair or modify parts that are broken or defective. Please contact the store immediately.
2. This product is for home use only and not intended for commercial establishments.



ASSEMBLY TIME

40 MINUTES

## PARTS IDENTIFICATION











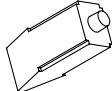

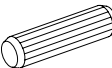
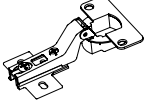
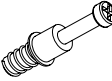
A	LEFT SIDE PANEL		1 PC	G	UPPER CROSS PANEL		2 PCS
B	RIGHT SIDE PANEL		1 PC	H	TOP PANEL		1 PC
C	FRONT CROSS BRACE		1 PC	I	UPPER BACK PANEL		3 PCS
D	BOTTOM PANEL		1 PC	JN	LOWER BACK PANEL		1 PC
E	ADJUSTABLE SHELF		1 PC	K	DOOR		1 PC
F	LOWER CROSS PANEL		1 PC	L	BACK CROSS BRACE		1 PC

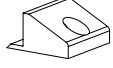
### NOTE:

Phillips head screw driver is required in the assembly process; however, manufacturer does not provide this item.

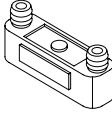
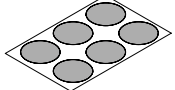
ITEM:707726

**HARDWARE IDENTIFICATION**

Z							
NO	DESCRIPTION	FIGURE	Q'TY	NO	DESCRIPTION	FIGURE	Q'TY
1	GLUE 40g		1 PC	10	NUT M5		2 PCS
2	WOODEN DOWEL ø8x30mm		28 PCS	11	HINGE ø35mm SR		2 PCS
3	CAM BOLT ø7x35.5mm SR		16 PCS	12	HINGE SCREW ø4x15mm SR		8 PCS
4	CAM LOCK ø15x12mm SR		16 PCS	13	FIXER		6 PCS
5	PLASTIC FEET Ø15mm		4 PCS	14	FIXER SCREW ø3x19mm SR		6 PCS
6	PIN FOR ADJUSTABLE SHELF ø4.9x8mm SR		4 PCS	15	SCREW Ø4.5x42mm SR		4 PCS
7	DOOR CATCH		1 PC	16	STICKER ø20mm		3 PCS
8	HANDLE BLK		1 PC	17	PLASTIC COVER Ø 52mm		1 PC
9	HANDLE BOLT M5x25mm BLK		2 PCS				

Z8,Z9,Z10,Z11 not included in blister packaging.

**NOTE:**

Phillips head screw driver is required in the assembly process; however, manufacturer does not provide this item.

ITEM: 707726

**STEP 1**

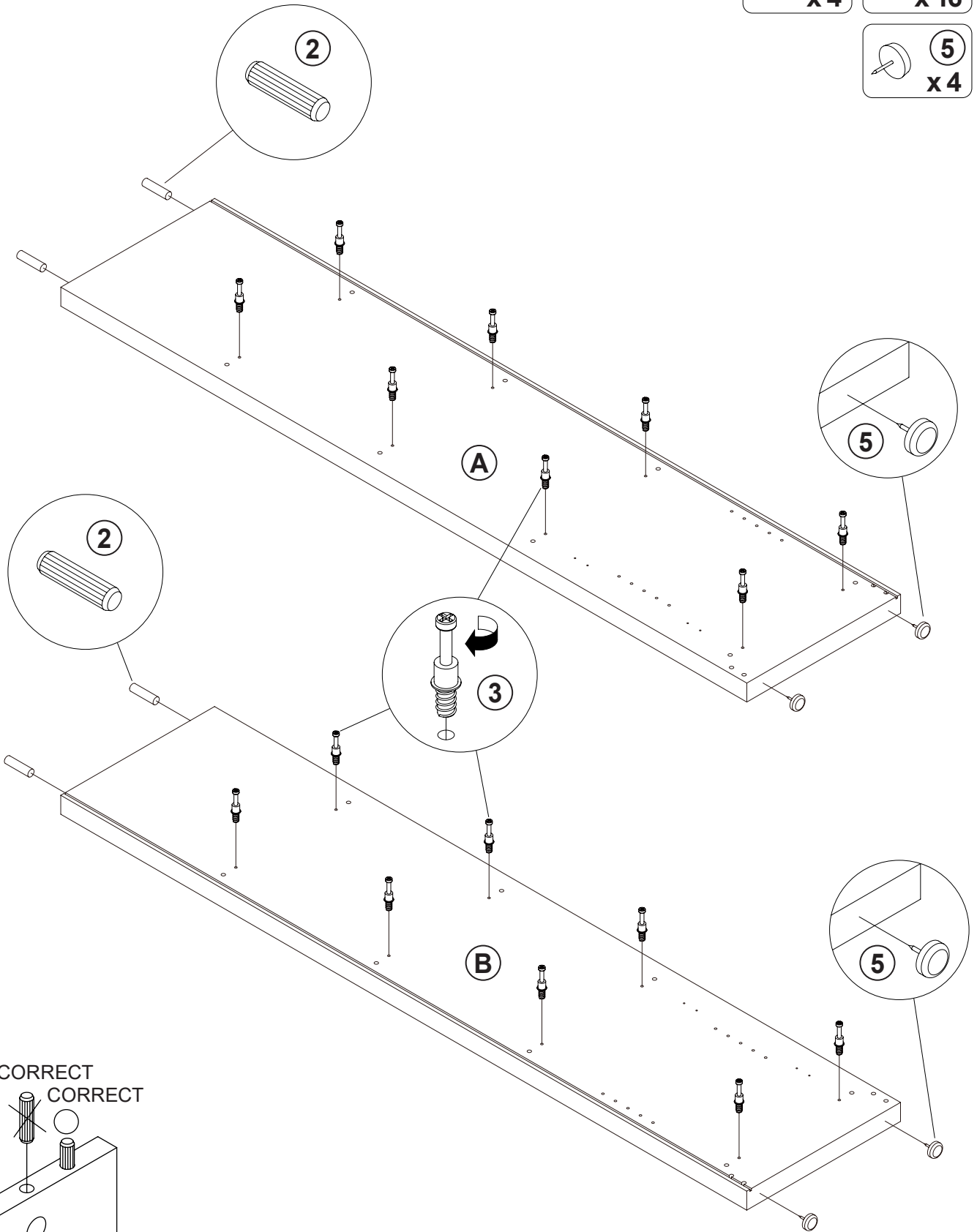
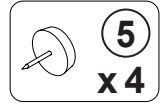
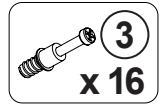
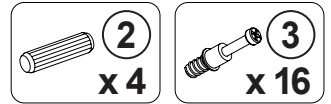

INCORRECT  
CORRECT

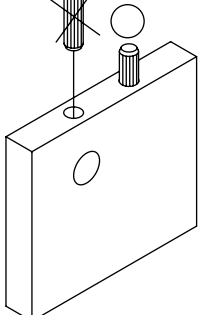

Apply glue on all wooden dowels to ensure integrity of the structure.

ITEM: 707726

**STEP 2**

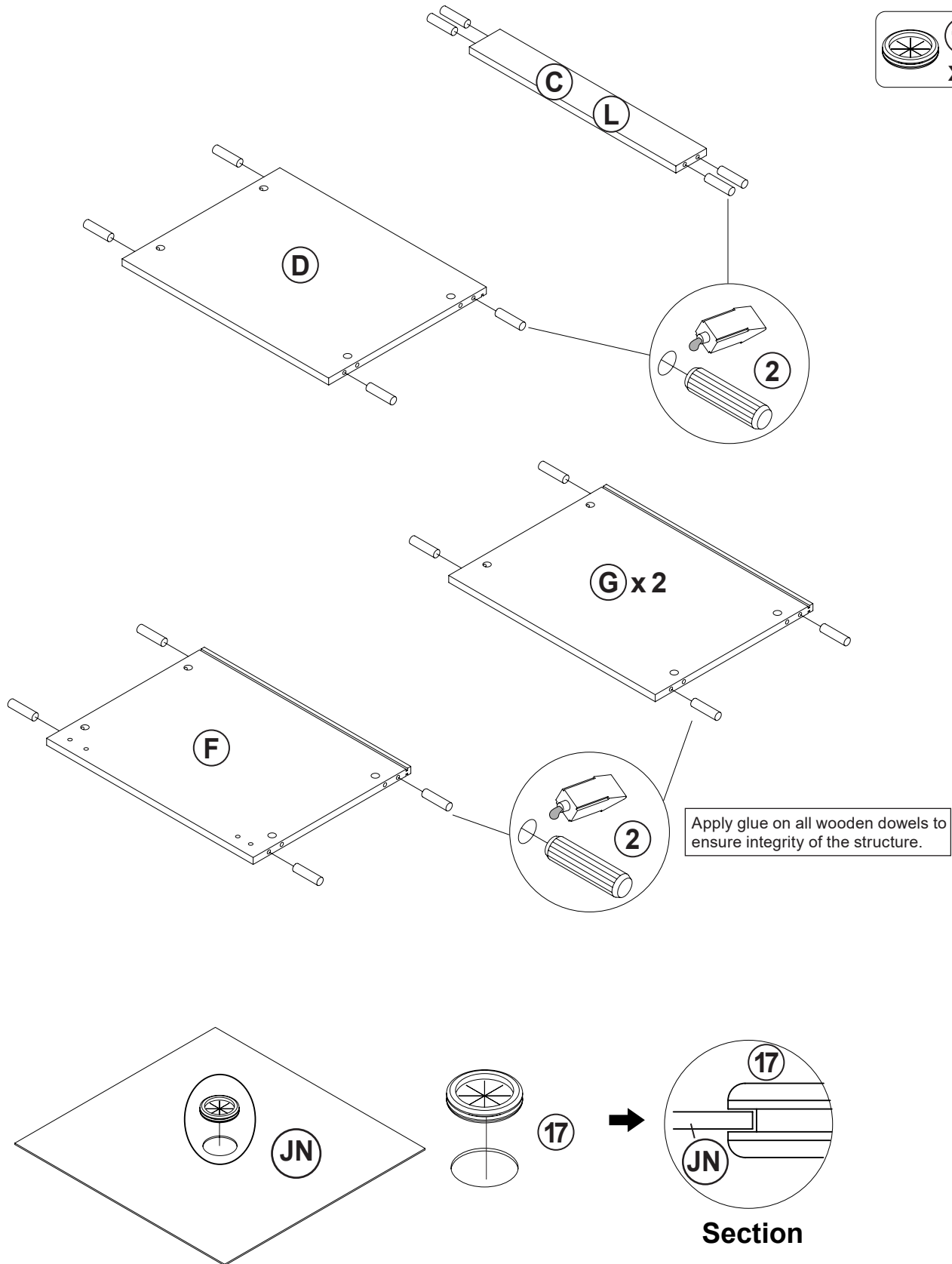
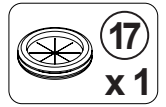
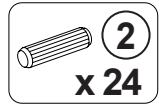

ITEM: 707726

**COASTER**  
FINE FURNITURE

**STEP 3**

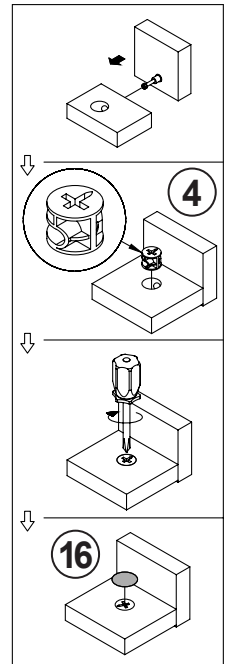
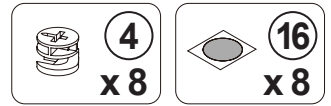
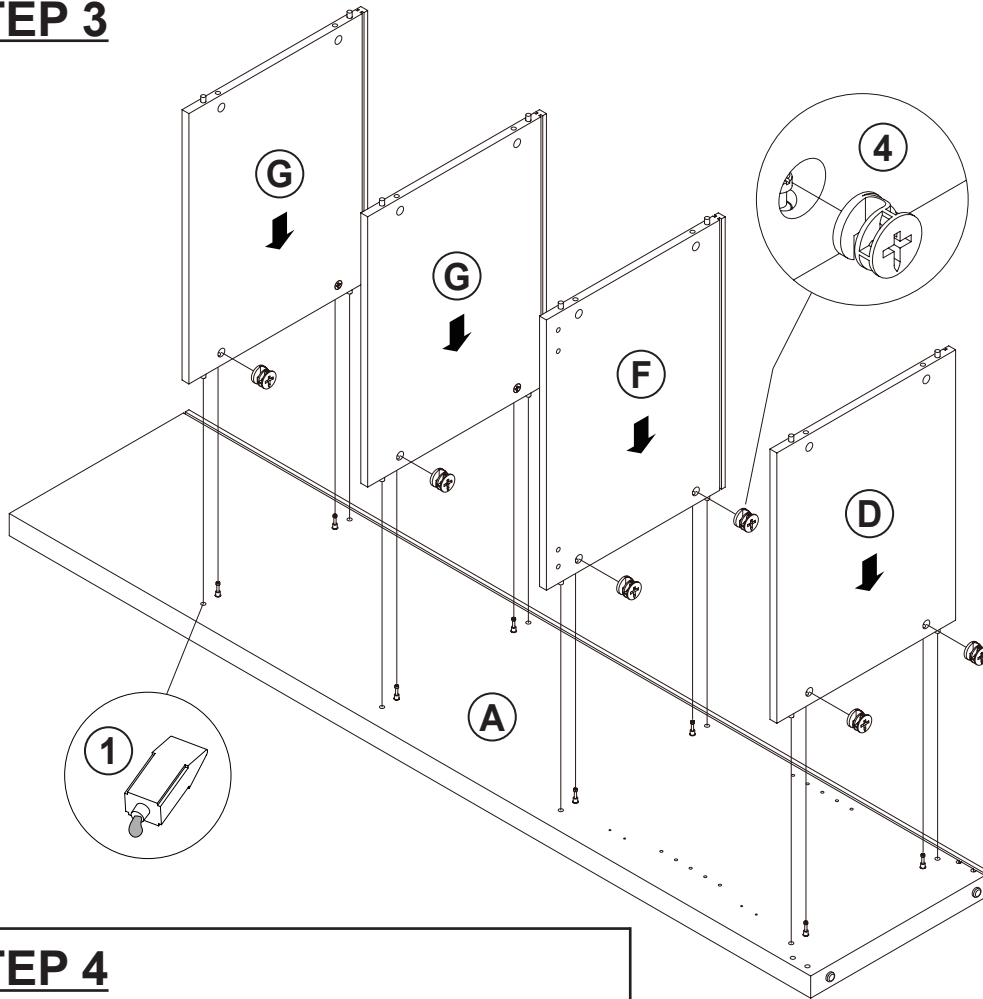

**STEP 4**

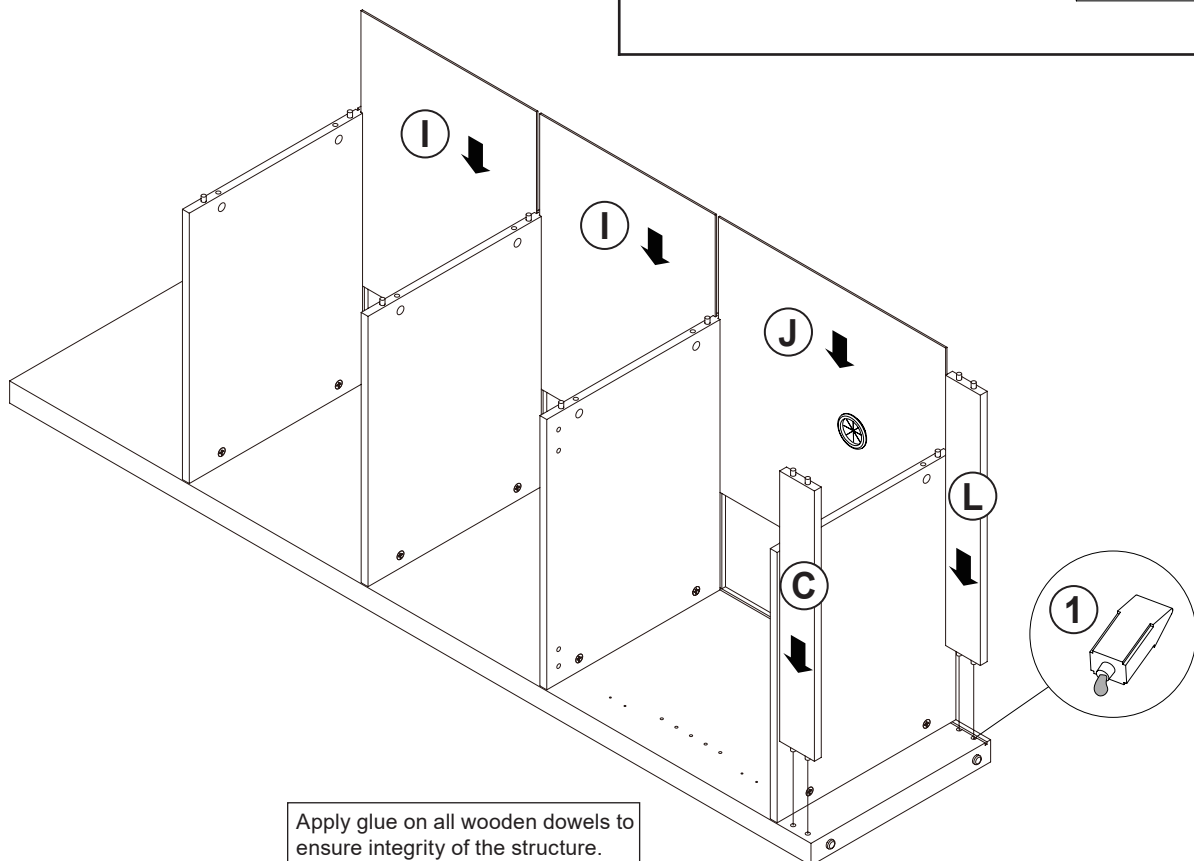

Apply glue on all wooden dowels to ensure integrity of the structure.

ITEM: 707726

**COASTER**  
FINE FURNITURE

**STEP 5**

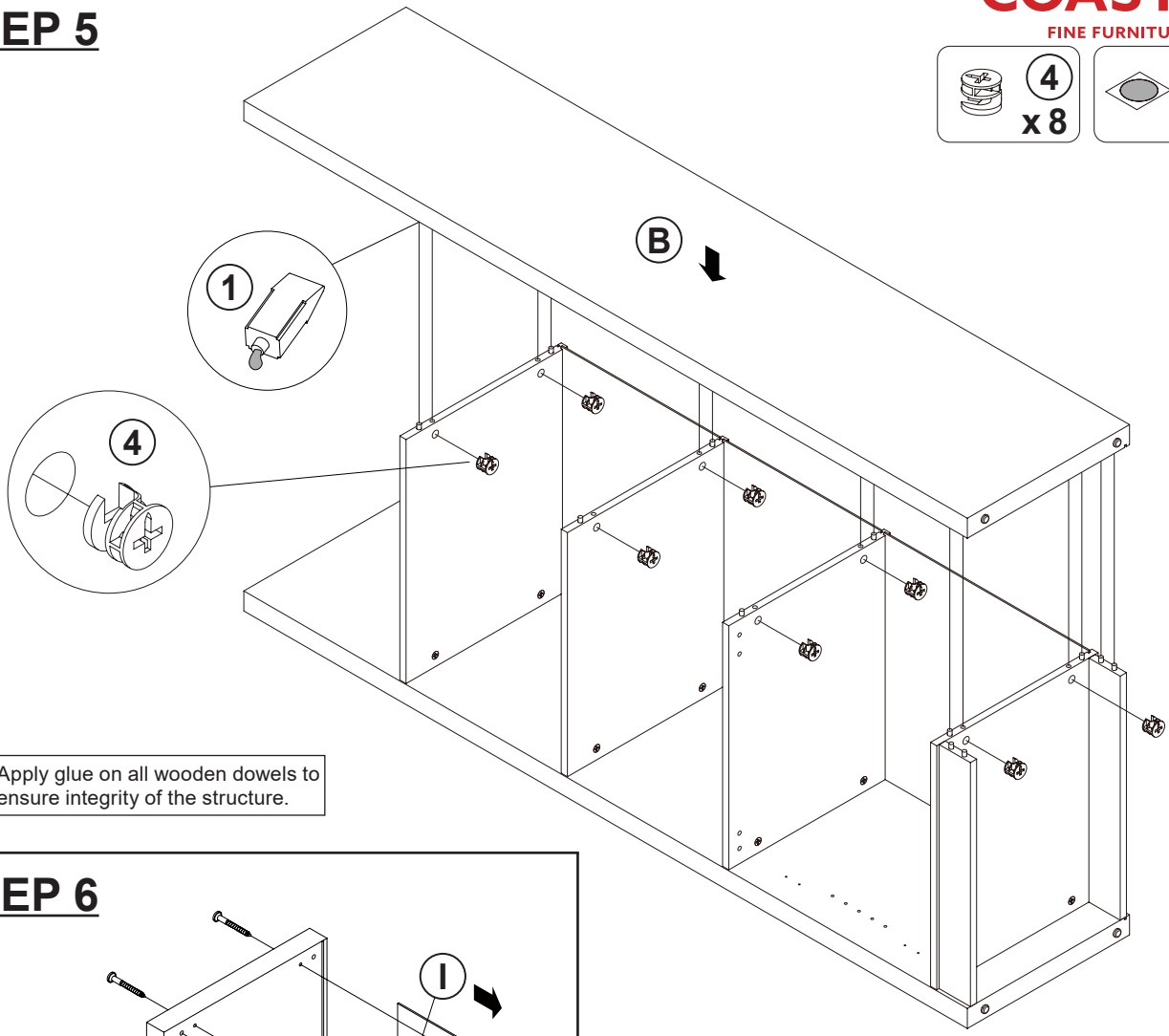
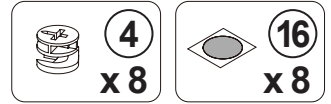

**STEP 6**

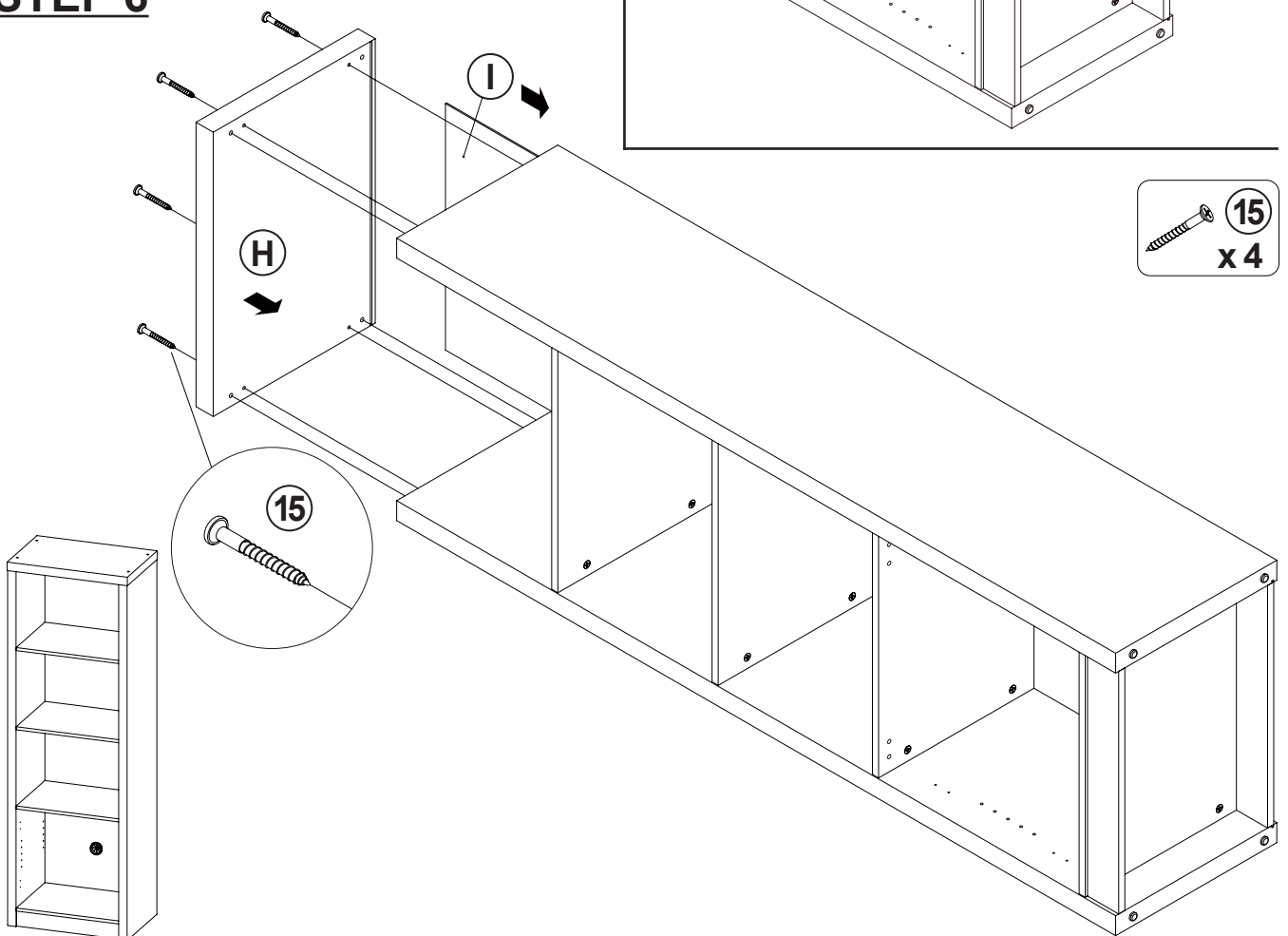
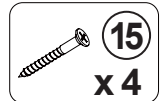

ITEM: 707726

**COASTER**  
FINE FURNITURE

**STEP 7**

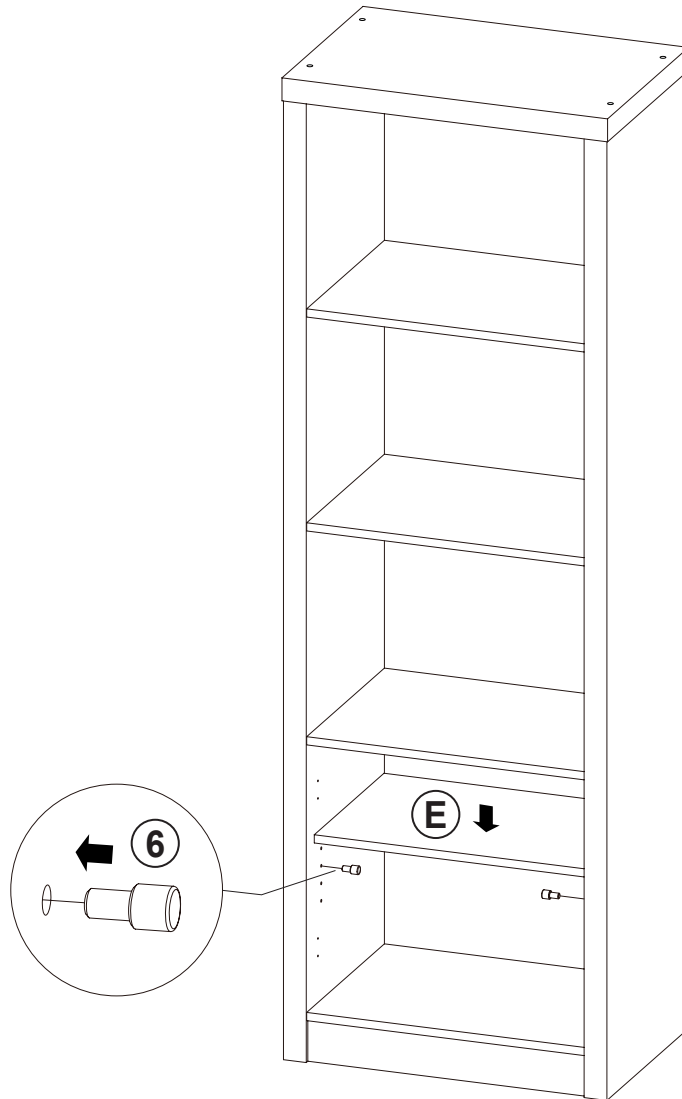
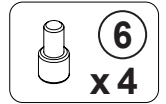

**STEP 8**

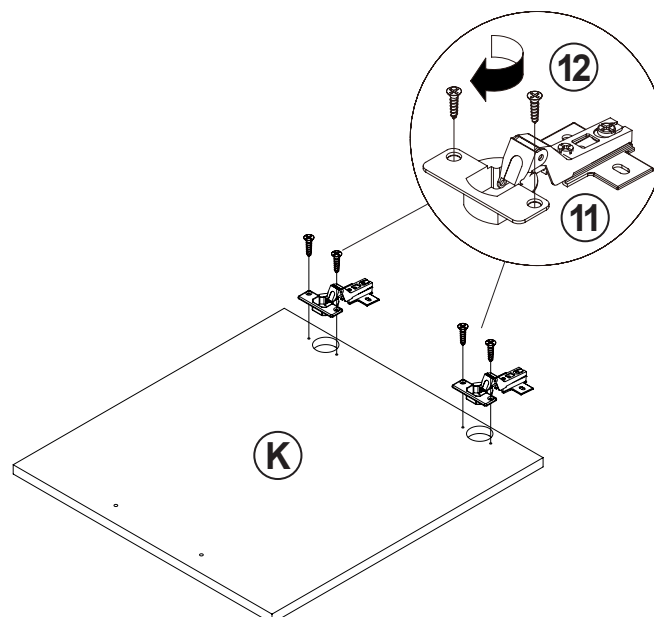
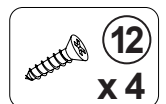
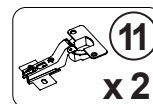



ITEM: 707726

**STEP 9**

LEFT

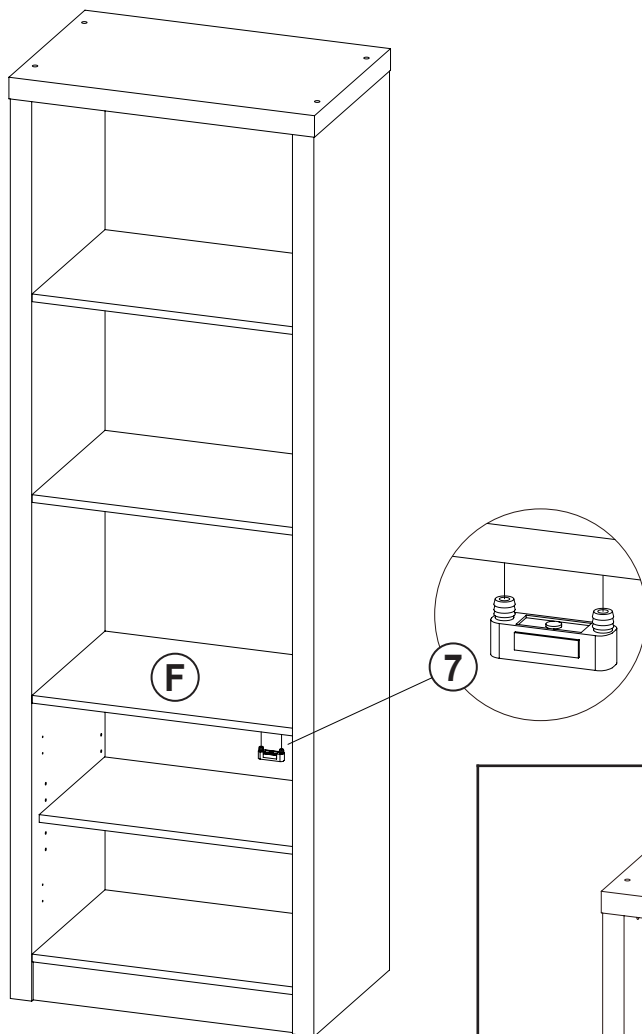
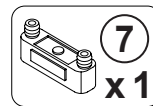

RIGHT

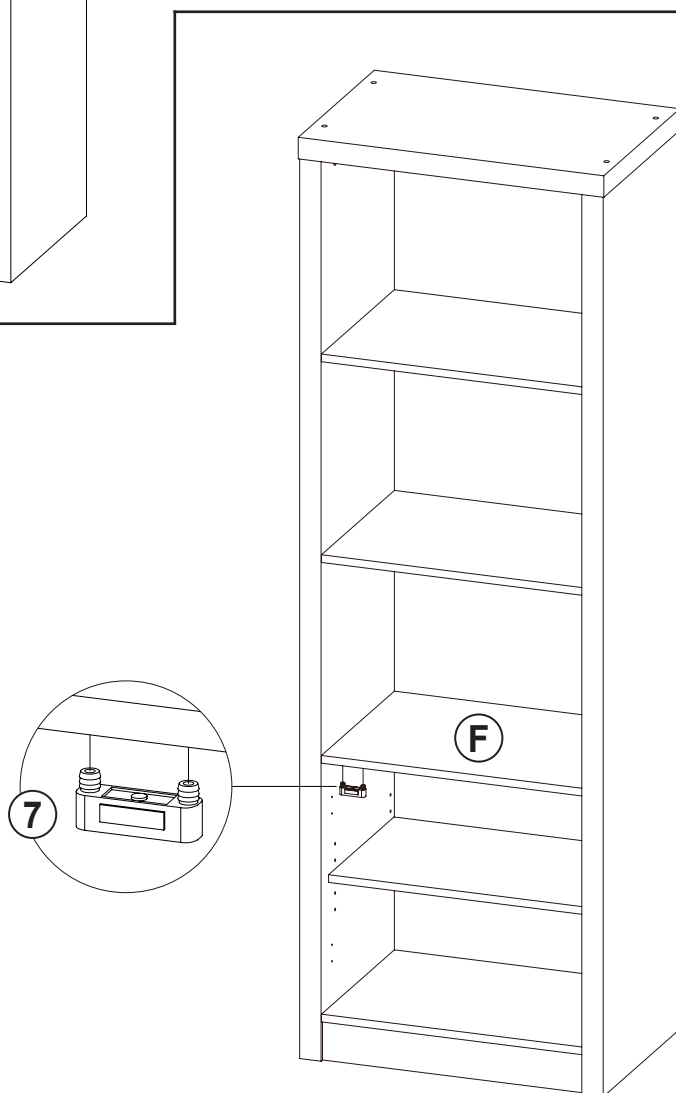

ITEM: 707726

**COASTER**<sup>®</sup>

FINE FURNITURE

**STEP 10**

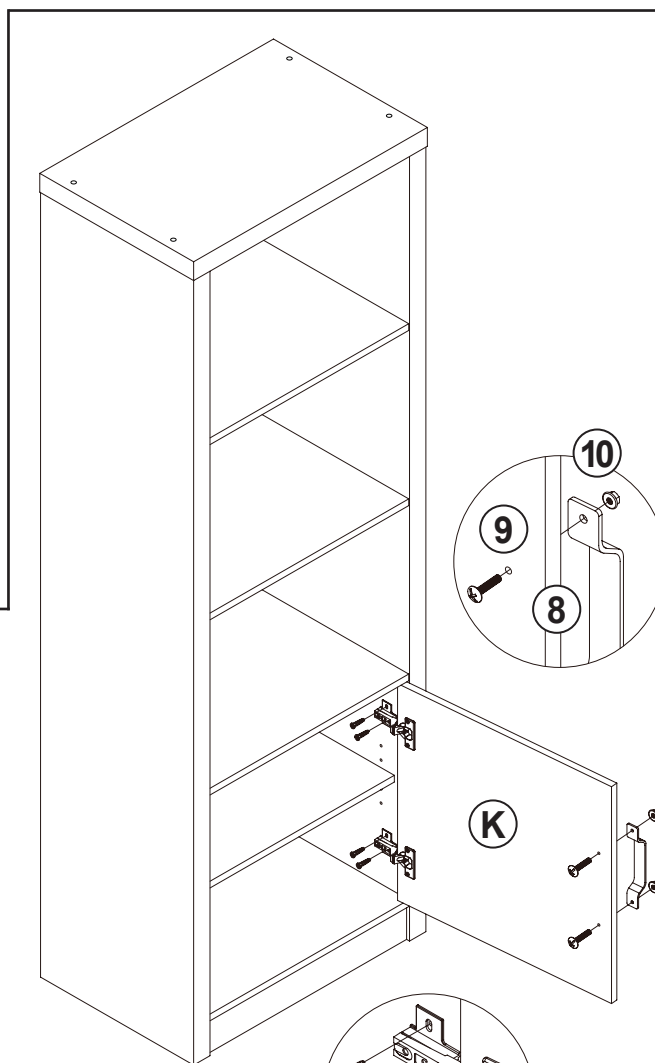
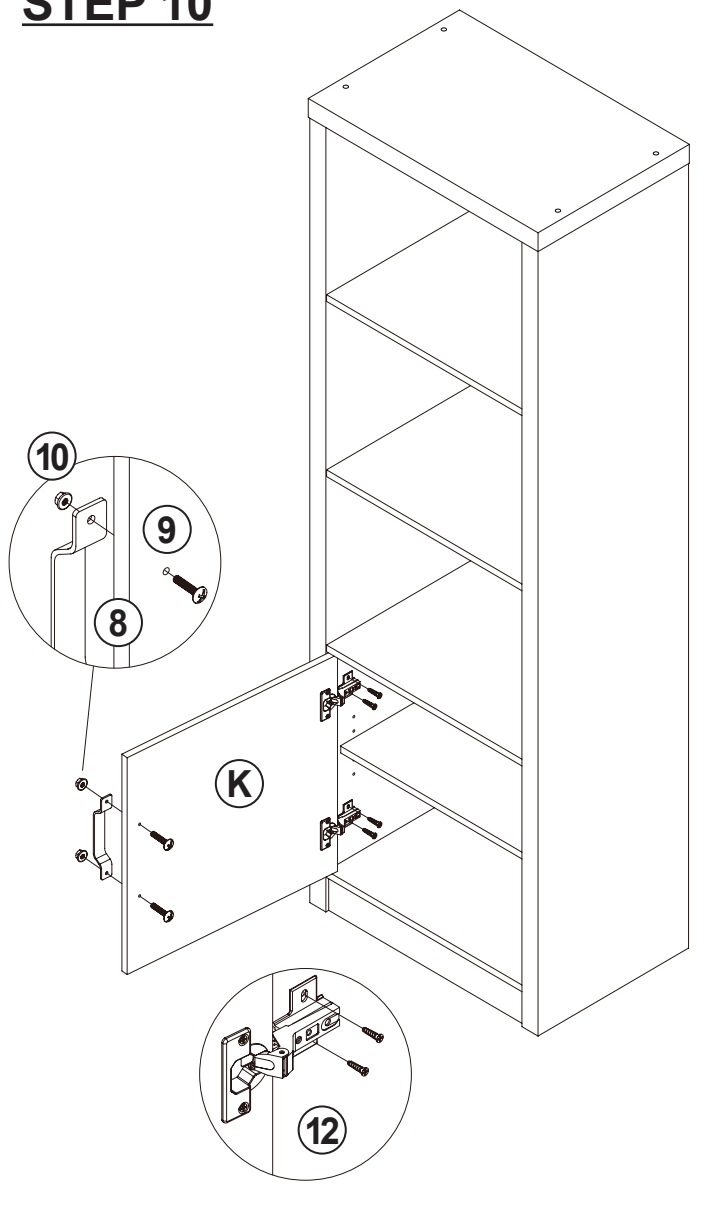
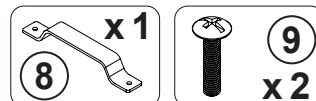

RIGHT

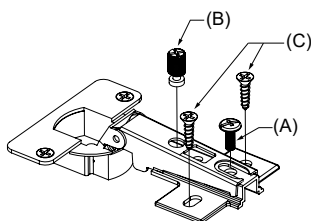

HORIZONTAL BY  
SCREW A ADJUSTMENT

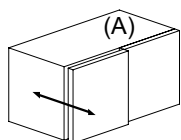

LATERAL BY  
SCREW B ADJUSTMENT

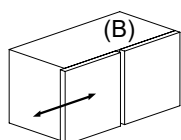

VERTICAL BY  
SCREW C ADJUSTMENT

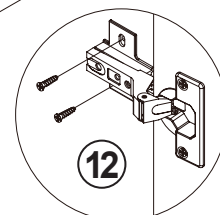
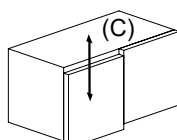

ITEM: 707726

**STEP 11**

**COASTER**  
FINE FURNITURE

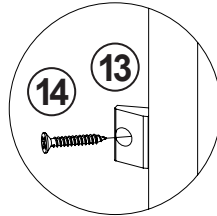
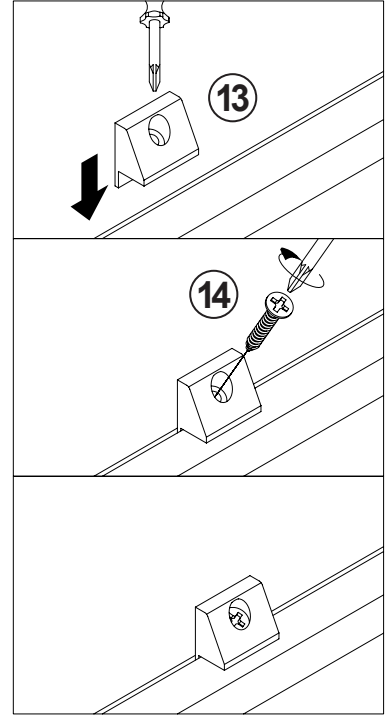
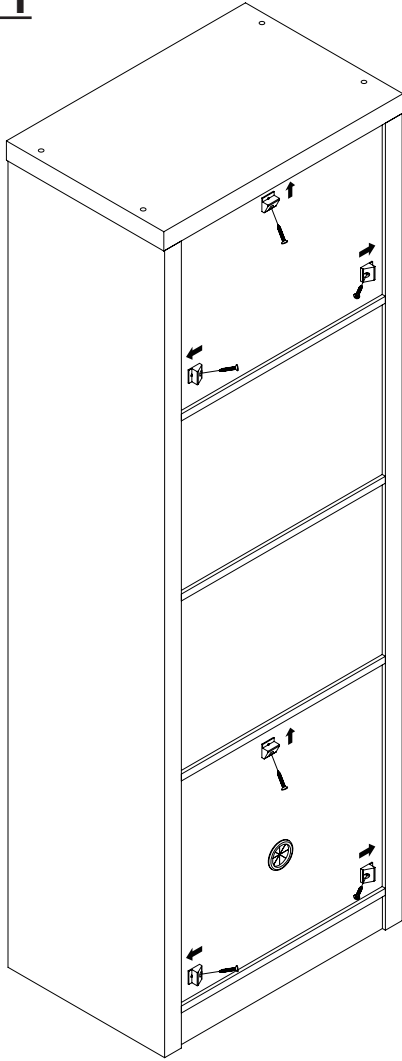
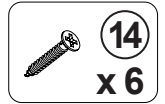
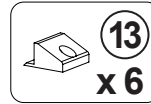

**STEP 12**

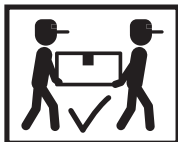
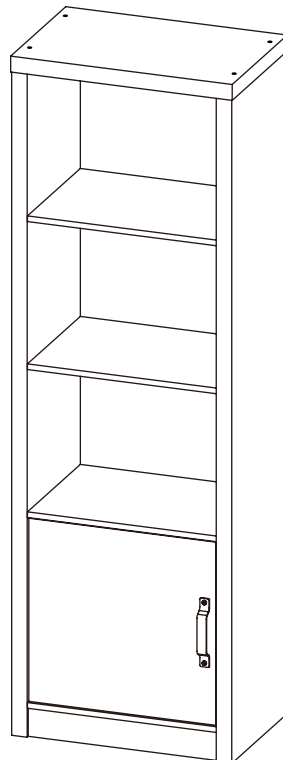

ITEM: 707726

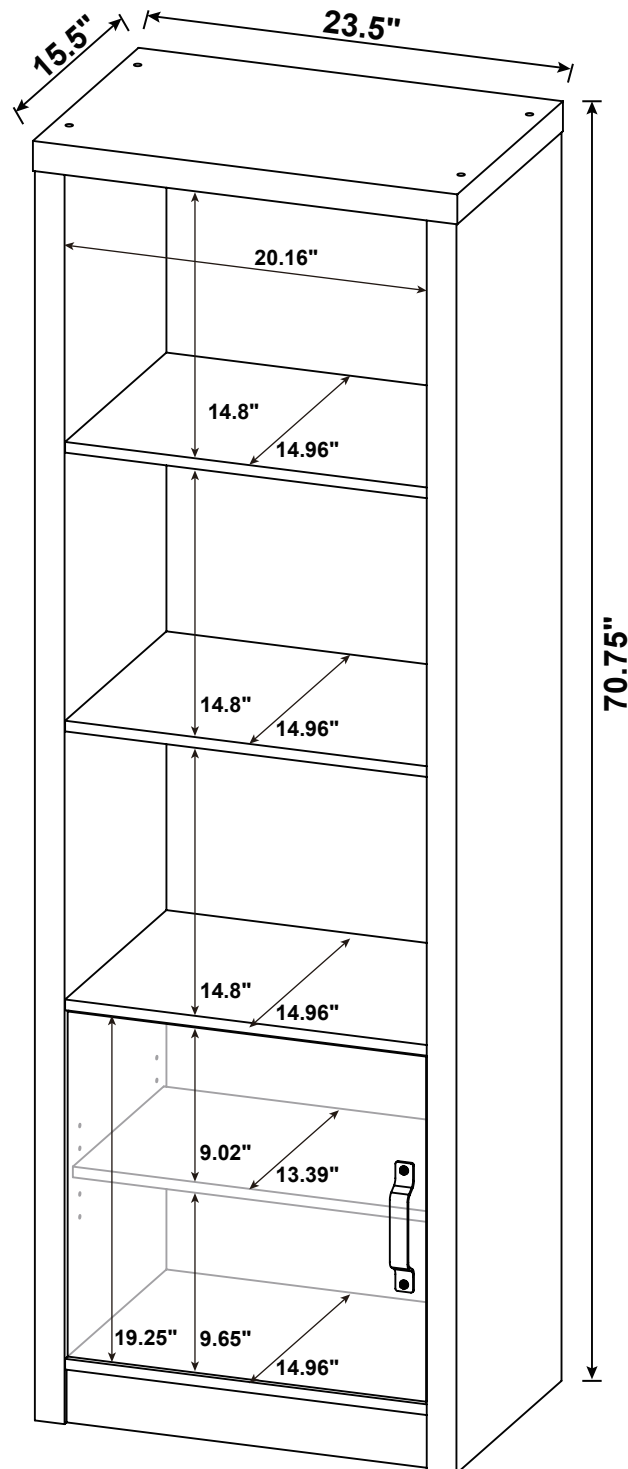

Note : Dimension tolerance  $\pm 5\%$

## ANTI-TIPPING INSTALLMENT INSTRUCTIONS FURNITURE TIPPING RESTRAINT

### WARNING

Injury may result from tipping furniture.  
This restraint may protect against tipping furniture.  
Do not allow children to climb on furniture.  
This restraint is not a substitute for proper adult supervision.  
Failure to detach this restraint before moving the furniture may result in injury and damage.

This restraint must be screwed to a wood stud on the wall, using the long screw provided.

### STEP 1

Secure the bracket to the back top of the unit, using the short screw provided, as shown in the drawing.

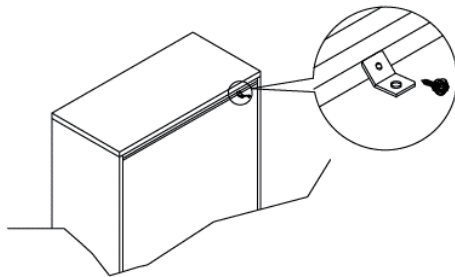

### STEP 2

Locate the wood stud on the wall, and secure the other bracket, 2 inches below the back of the unit.

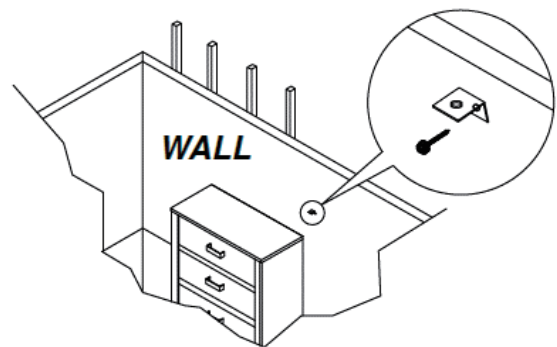

### STEP 3

Place the furniture into position so both mounting brackets are vertically in line. Lace the end of the restraint strap through the larger hole in each mounting bracket. Bring both ends together and slide the flat end through the locking end, and drag it through, until the slack is removed. Ensure that the strap is securely laced and locked.

