

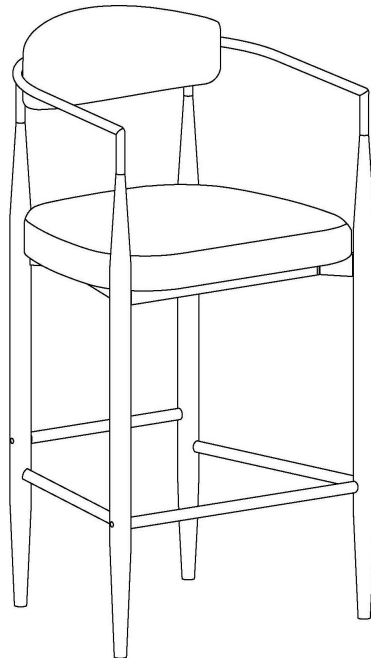

ASSEMBLY INSTRUCTIONS

COASTER FINE FURNITURE



Fine Furniture for every stage of life

121186

COUNTER STOOL

REVISION 0: 12/18/2023
REVISION 1: 10/25/2024

ITEM:121186



ASSEMBLY INSTRUCTIONS

ASSEMBLY TIPS:

1. Remove hardware from box and sort by size.
2. Please check to see that all hardware and parts are present prior to start of assembly.
3. Please follow attached instructions in the same sequence as numbered to assure fast & easy assembly.



WARNING

1. Don't attempt to repair or modify parts that are broken or defective. Please contact the store immediately.
2. This product is for home use only and not intend for commercial establishments.

ASSEMBLY TIME

20 MINUTES

PARTS IDENTIFICATION

A SEAT



1PC

B BACKREST

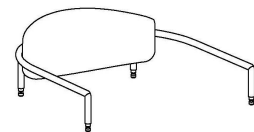

1PC

C LEFT METAL LEG FRAME



1PC

D RIGHT METAL LEG FRAME

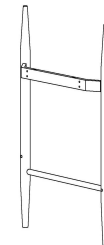

1PC

E BACK UPPER RAIL



1PC

F FRONT UPPER RAIL



1PC

G BACK BOTTOM RAIL



1PC

H FOOTREST



1PC

HARDWARE IDENTIFICATION

1 BOLT



4PCS

5/32"x5/32"

2 BOLT

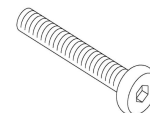

8PCS

1/4" x 2-1/8"

3 BOLT



8PCS

1/4" x 5/8"

4 SPRING WASHER



12PCS

1/4"

5 WASHER



12PCS

1/4"

6 ALLEN KEY



1PCS

4mm

7 ALLEN KEY



1PC

2mm

NOTE:

Quantities shown are for one stool.

ITEM:121186

ASSEMBLY INSTRUCTIONS



STEP 1

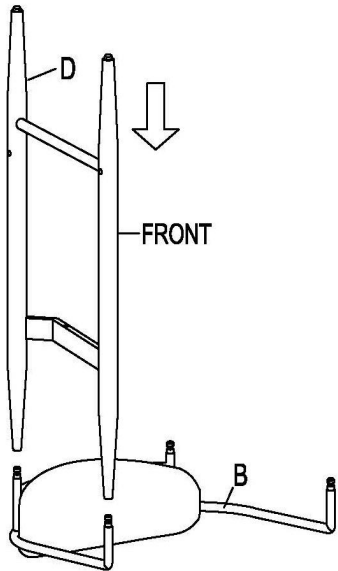

STEP 2

3		4PCS
4		4PCS
5		4PCS
6		1PC

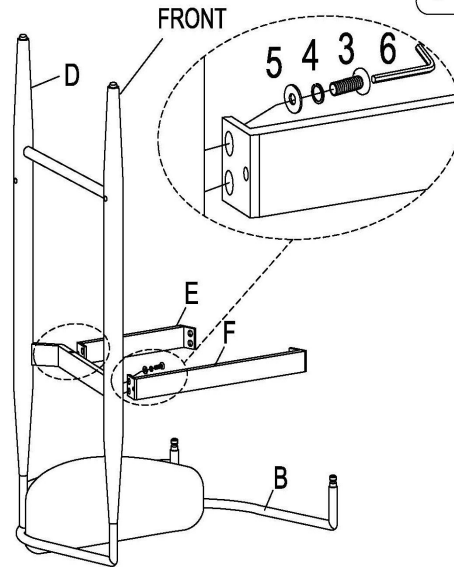

STEP 3

2		2PCS
6		1PC

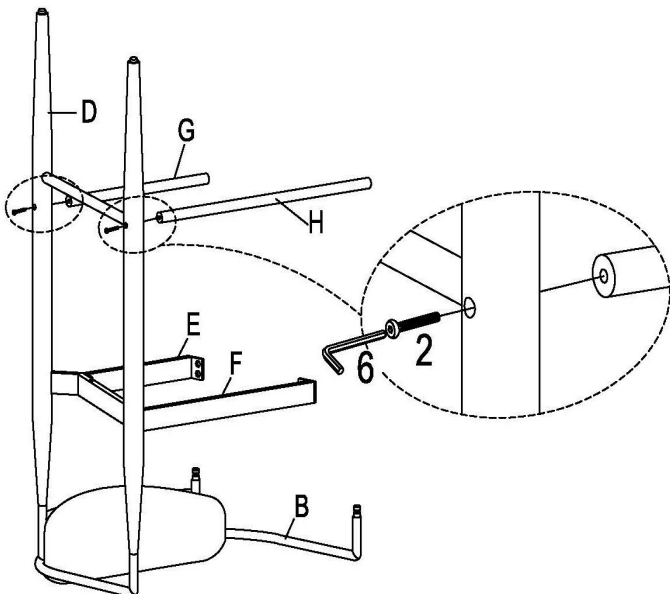

STEP 4

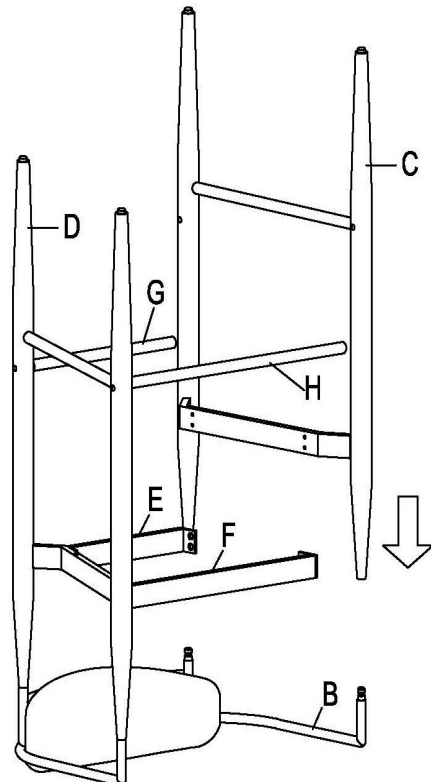

ITEM:121186

ASSEMBLY INSTRUCTIONS



STEP 5

3		4PCS
4		4PCS
5		4PCS
6		1PC

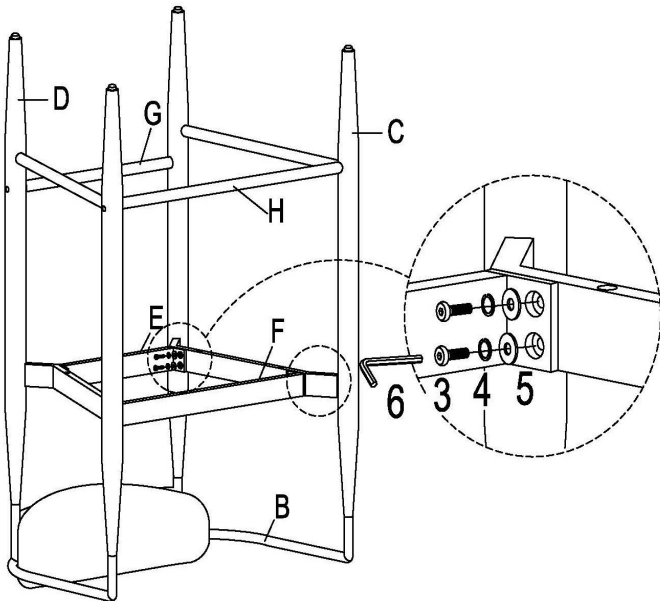

STEP 6

2		2PCS
6		1PC

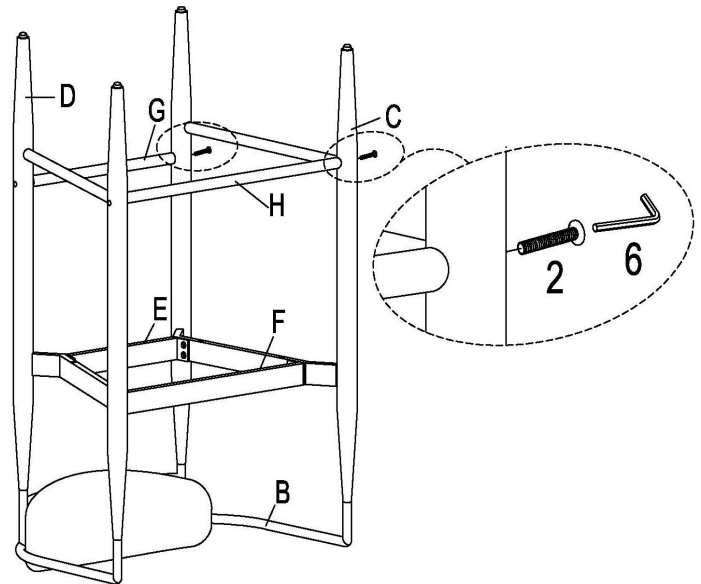

STEP 7

2		4PCS
4		4PCS
5		4PCS
6		1PC

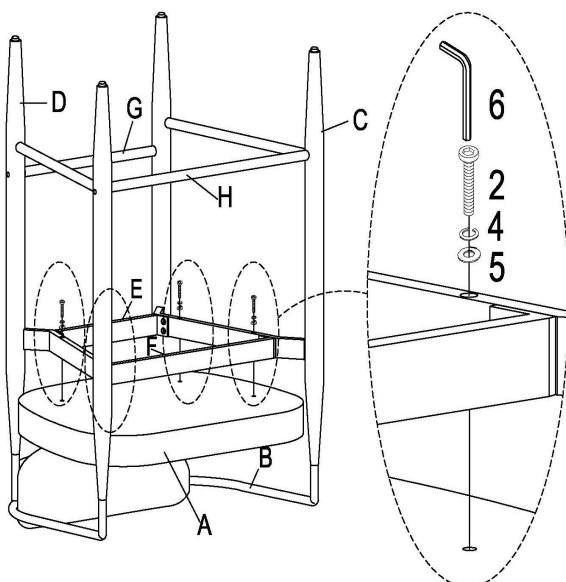

STEP 8

1		4PCS
7		1PC

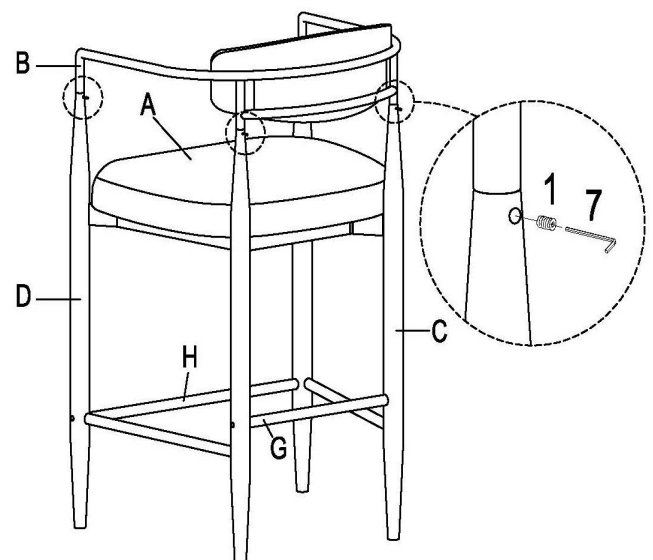

ITEM:121186

STEP 9
COMPLETE

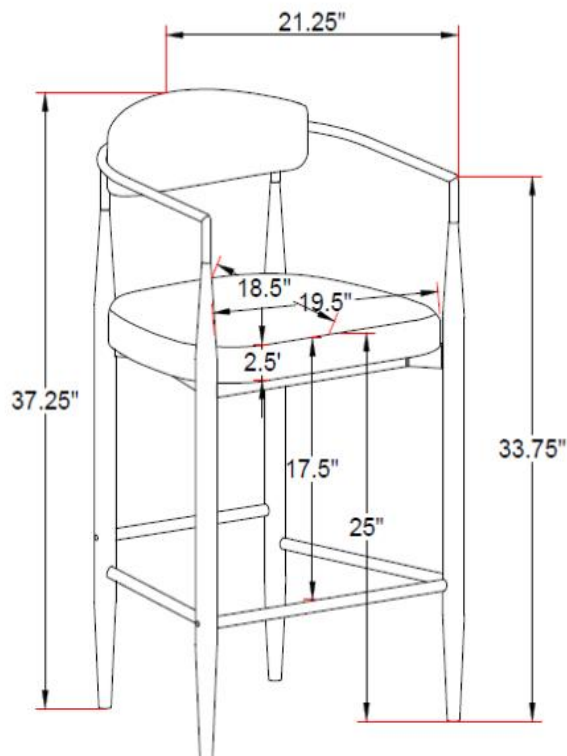
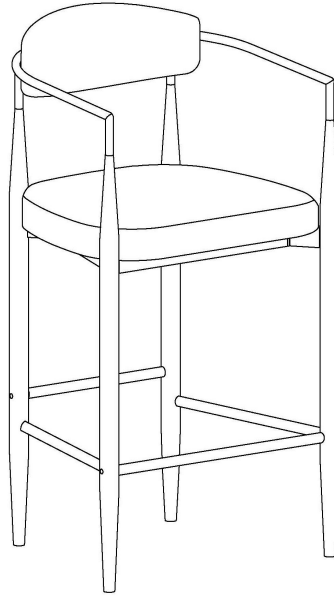

Note: Dimension tolerance $\pm 5\%$