

*ASSEMBLY INSTRUCTIONS*  
*COASTER FINE FURNITURE*

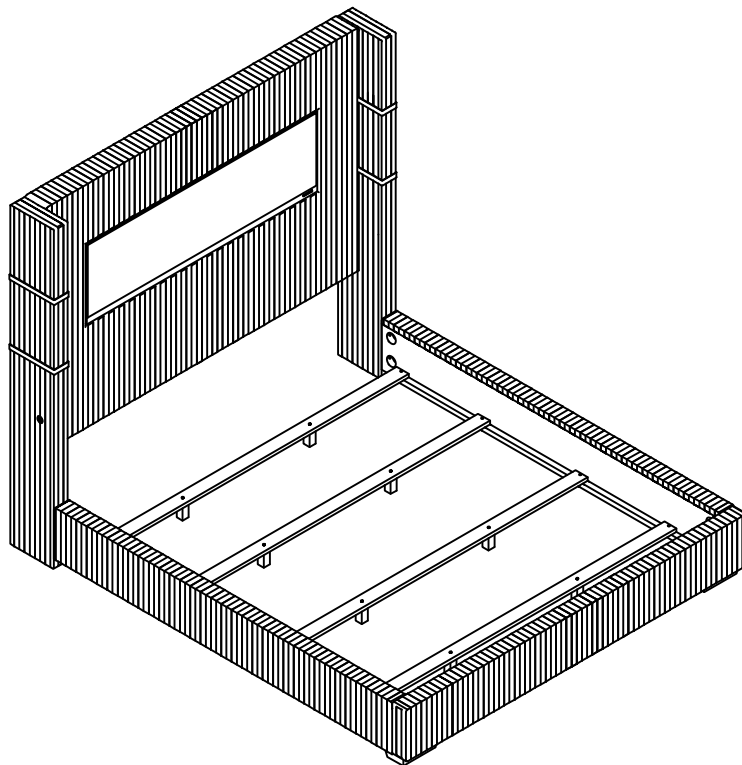

*Fine Furniture for every stage of life*

**306030KW**  
***California King Bed***

# ITEM: 306030KW



## ASSEMBLY INSTRUCTIONS

### ASSEMBLY TIPS:

1. Remove hardware from box and sort by size.
2. Please check to see that all hardware and parts are present prior to start of assembly.
3. Please follow attached instructions in the same sequence as numbered to assure fast & easy assembly.



### WARNING!

1. Don't attempt to repair or modify parts that are broken or defective. Please contact the store immediately.
2. This product is for home use only and not intended for commercial establishments.



ASSEMBLY TIME

15 MINUTES

## PARTS IDENTIFICATION

A HEADBOARD		1PC	G BED SLAT SUPPORT WITH LEVELER		8PCS
B LEFT HEADBOARD LEG		1PC	H LEFT FOOTBOARD LEG		1PC
C RIGHT HEADBOARD LEG		1PC	I RIGHT FOOTBOARD LEG		1PC
D FOOTBOARD PANEL		1PC	J ADAPTER		1PC
E BED RAIL		2PCS	K REMOTE CONTROL		1PC
F BED SLAT		4PCS			

# ITEM: 306030KW



## ASSEMBLY INSTRUCTIONS

### ASSEMBLY TIPS:









1. Remove hardware from box and sort by size.
2. Please check to see that all hardware and parts are present prior to start of assembly.
3. Please follow attached instructions in the same sequence as numbered to assure fast & easy assembly.

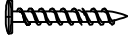

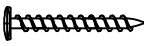
### WARNING!

1. Don't attempt to repair or modify parts that are broken or defective. Please contact the store immediately.
2. This product is for home use only and not intended for commercial establishments.

## HARDWARE IDENTIFICATION

1	<b>THREADED BOLT</b> (Ø5/16" x 90mm - BLK)		14PCS	6	<b>SHORT FLAT HEAD SCREW</b> (M4 x 30mm - BLK)		8PCS
2	<b>CURVED WASHER</b> (Ø5/16" - BLK)		8PCS	7	<b>LONG FLAT HEAD SCREW</b> (M4 x 50mm - BLK)		8PCS
3	<b>HEX NUT</b> (Ø5/16" - BLK)		14PCS	8	<b>WRENCH</b> (14mm - BLK)		1PC
4	<b>BIG FLAT WASHER</b> (Ø5/16" - BLK)		6PCS	9	<b>SMALL FLAT WASHER</b> (Ø1/4" - BLK)		8PCS
5	<b>LOCK WASHER</b> (Ø5/16" - BLK)		6PCS				

### NOTE:

Phillips head screw driver is required in the assembly process; however, manufacturer does not provide this item.

ITEM: **306030KW**

**ASSEMBLY INSTRUCTIONS**

**STEP 1**

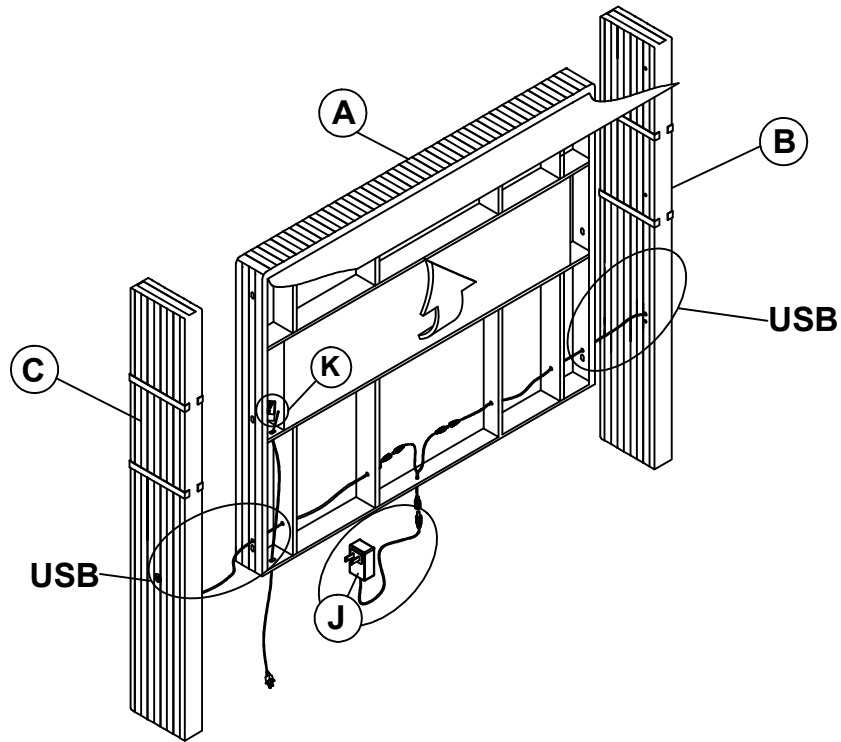

**BACK VIEW**

**STEP 2**

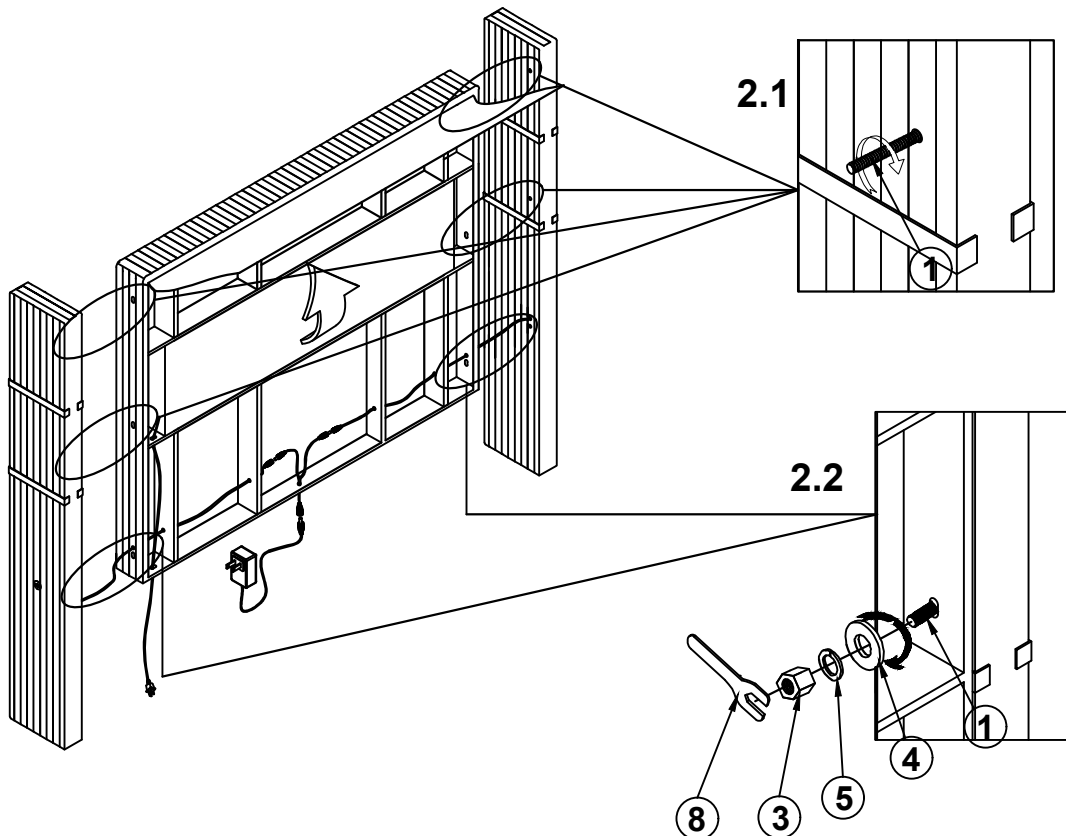

ITEM: **306030KW**

**ASSEMBLY INSTRUCTIONS**

**STEP 3**

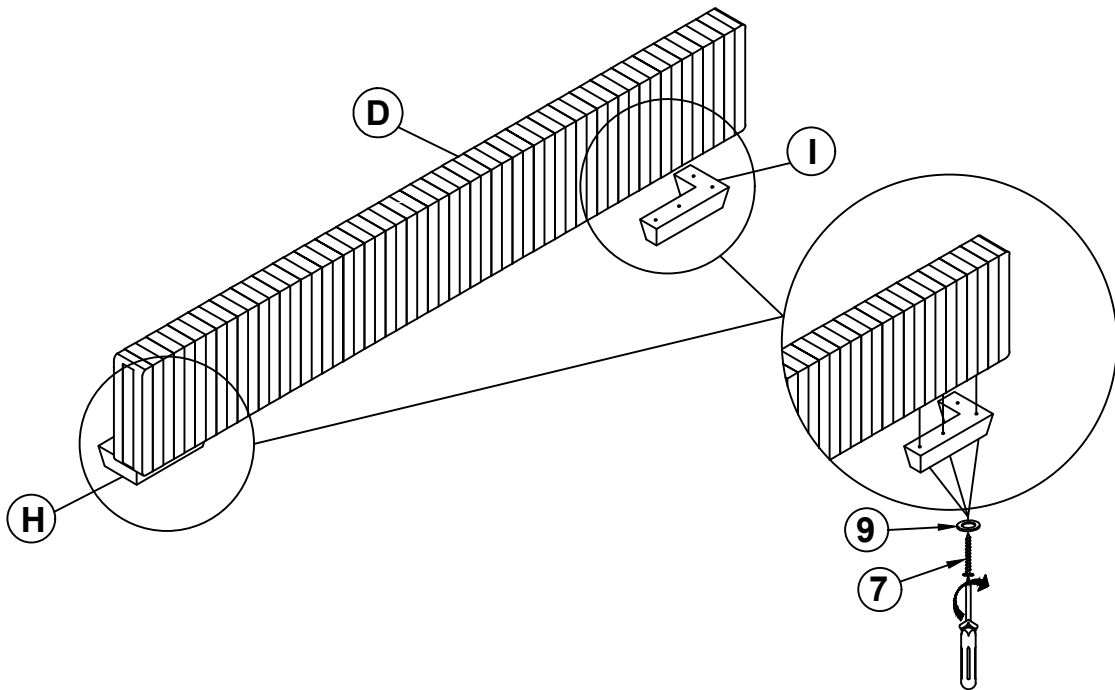

**STEP 4**

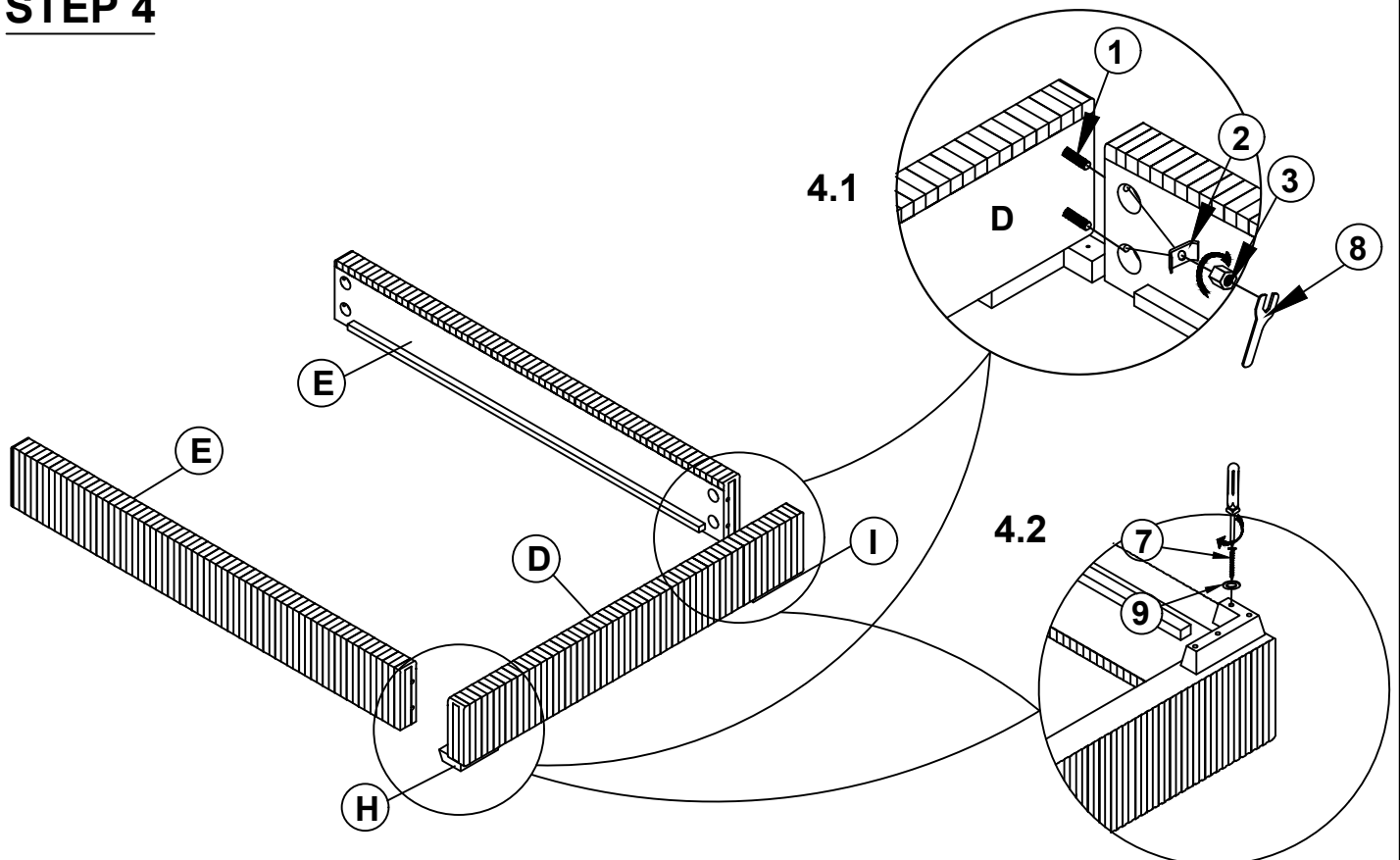

ITEM: **306030KW**  
**ASSEMBLY INSTRUCTIONS**  
**STEP 5**

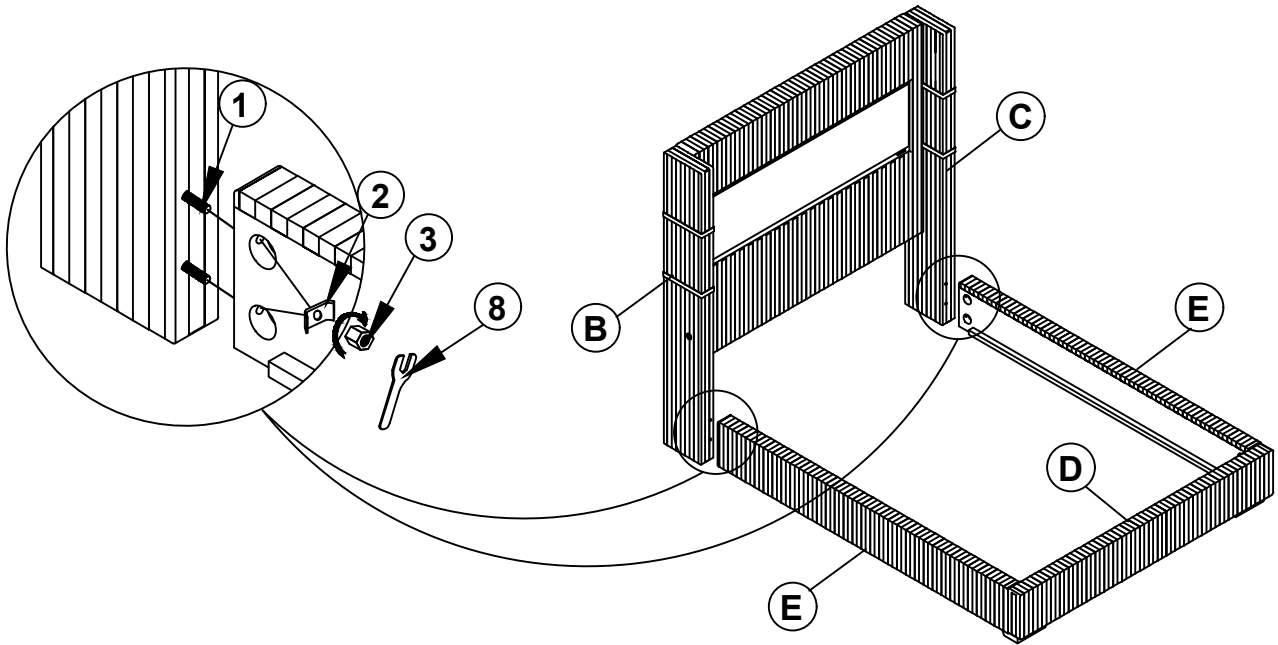

**STEP 6**

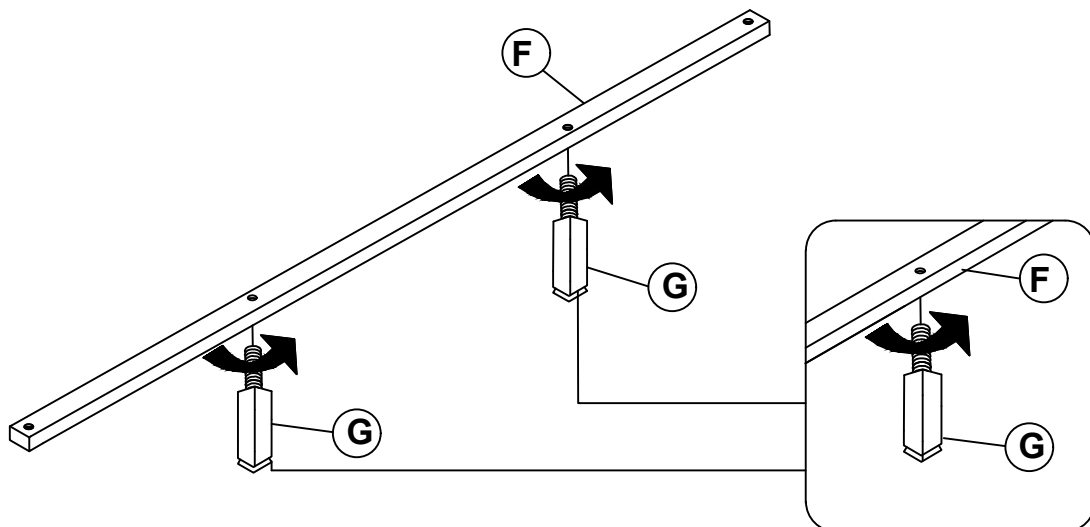

ITEM: **306030KW**

**ASSEMBLY INSTRUCTIONS**

**STEP 7**

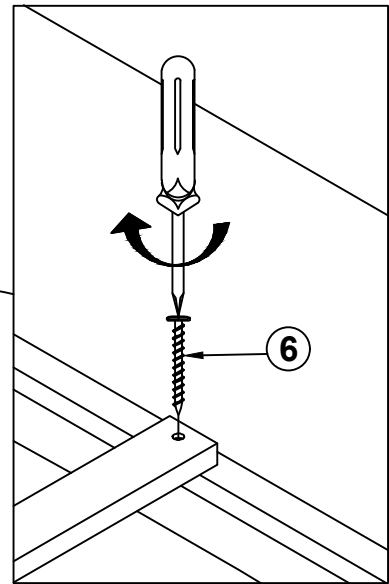
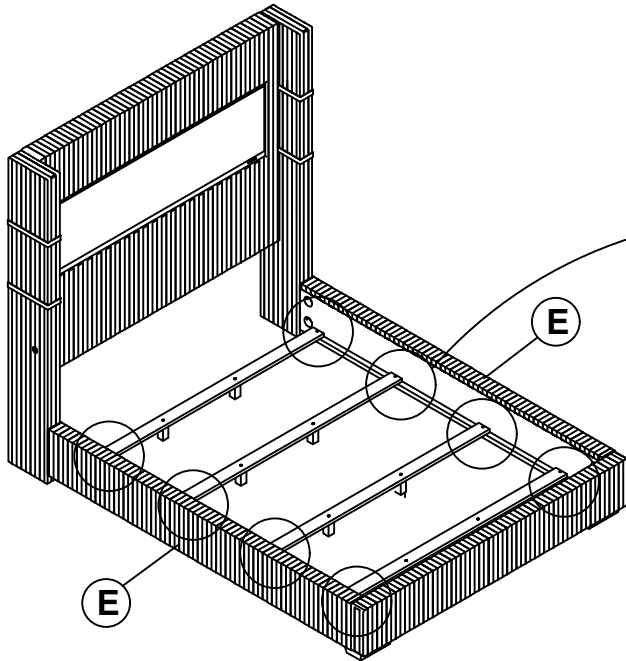

**STEP 8**  
**COMPLETE**

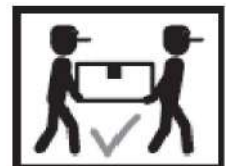
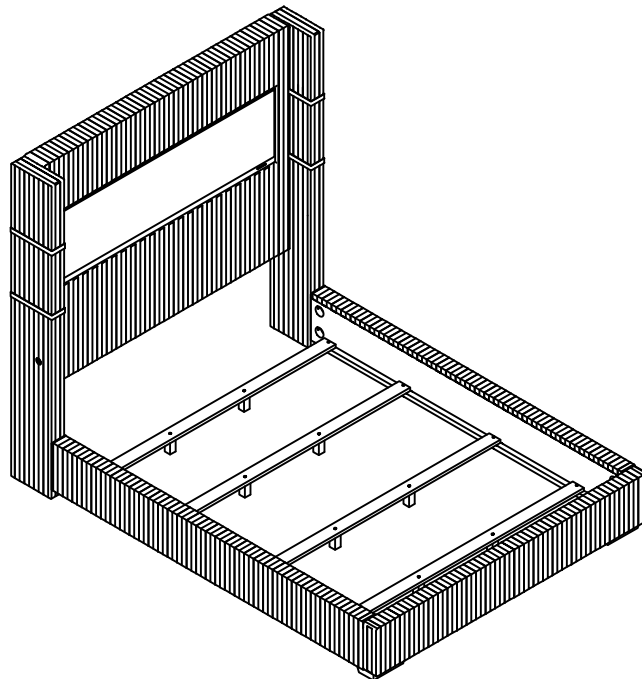

ITEM: **306030KW**



Inner Size: 73.00"W X 86.00"D

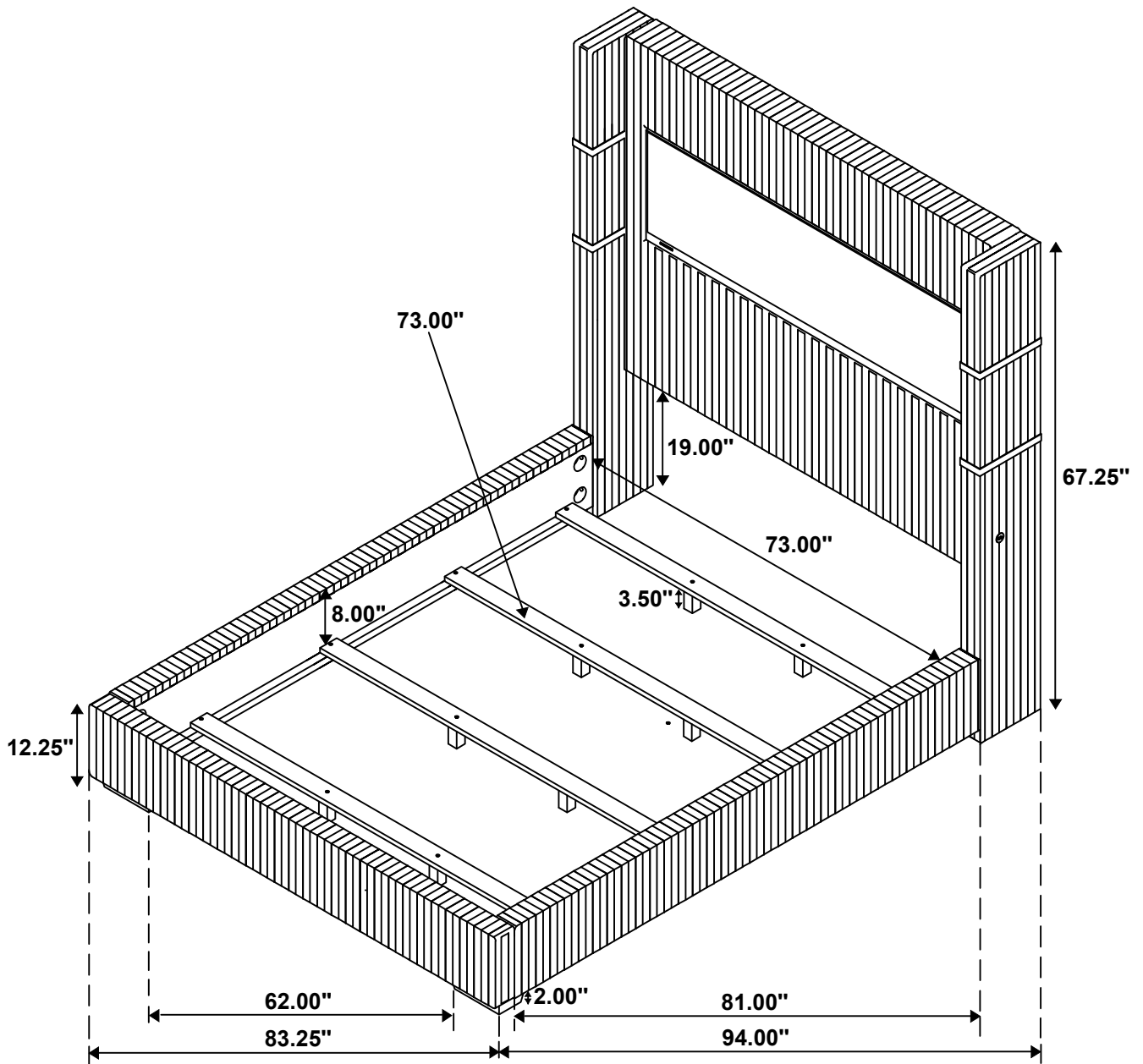

Note: Dimension tolerance  $\pm 5\%$