



ASSEMBLY INSTRUCTIONS
COASTER FINE FURNITURE



Fine Furniture for every stage of life

107872N
Dining chair

REVISION 0 : 08/20/2019
REVISION 1: 11/01/2023
REVISION 2: 11/15/2023
REVISION 3: 12/31/2024

PAGE 1 OF 5

COASTERFURNITURE.COM

ITEM: 107872N (B1-B2)



ASSEMBLY INSTRUCTIONS

ASSEMBLY TIPS:

1. Remove hardware from box and sort by size.
2. Please check to see that all hardware and parts are present prior to start of assembly.
3. Please follow attached instructions in the same sequence as numbered to assure fast & easy assembly.

WARNING!

1. Don't attempt to repair or modify parts that are broken or defective. Please contact the store immediately.
2. This product is for home use only and not intended for commercial establishments.



ASSEMBLY TIME

10 MINUTES

PARTS IDENTIFICATION

B1 (BOX 1)

A BACK

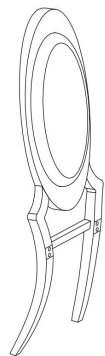

1PC

B2 (BOX 2)

B SEAT

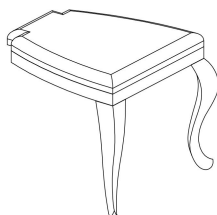

1PC

NOTE:

Quantities shown are for on chair

Phillips head screw driver is required in the assembly process; however, manufacturer does not provide this item.

ASSEMBLY INSTRUCTIONS

ASSEMBLY TIPS:

1. Remove hardware from box and sort by size.
2. Please check to see that all hardware and parts are present prior to start of assembly.
3. Please follow attached instructions in the same sequence as numbered to assure fast & easy assembly.







WARNING!

1. Don't attempt to repair or modify parts that are broken or defective. Please contact the store immediately.
2. This product is for home use only and not intended for commercial establishments.

HARDWARE IDENTIFICATION

Z-B2 (BOX 2) - HARDWARE PACK IS LOCATED IN 107872N (B2)

1	ALLEN WRENCH (65 x 64MM - RBW)		1PC
2	SHORT BOLT (M8*25mm)		4PCS
3	Spring Shim		4PCS
4	BARREL NUT (Dia10mm)		4PCS

Hardware pack is located in 107872N B2

NOTE:

Quantities shown are for on chair

Phillips head screw driver is required in the assembly process; however, manufacturer does not provide this item.

ITEM:107872N (B1-B2)

ASSEMBLY INSTRUCTIONS



STEP 1

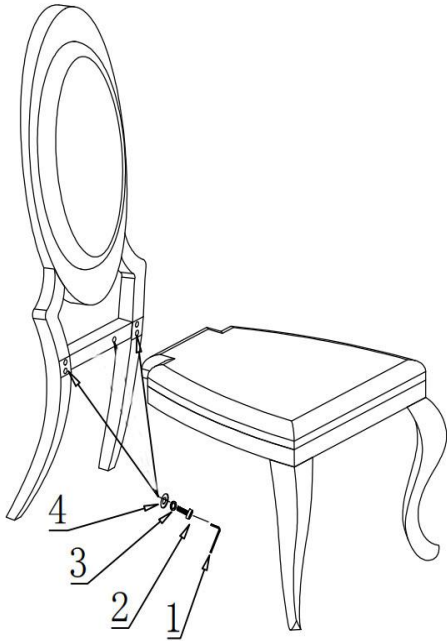

STEP 2

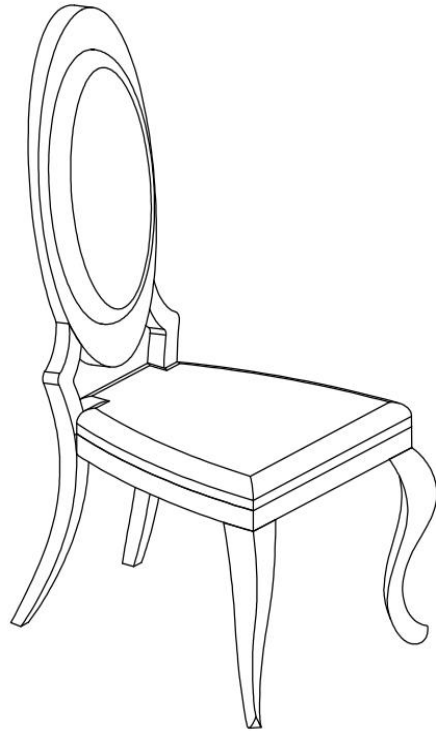

ITEM:107872N (B1-B2)

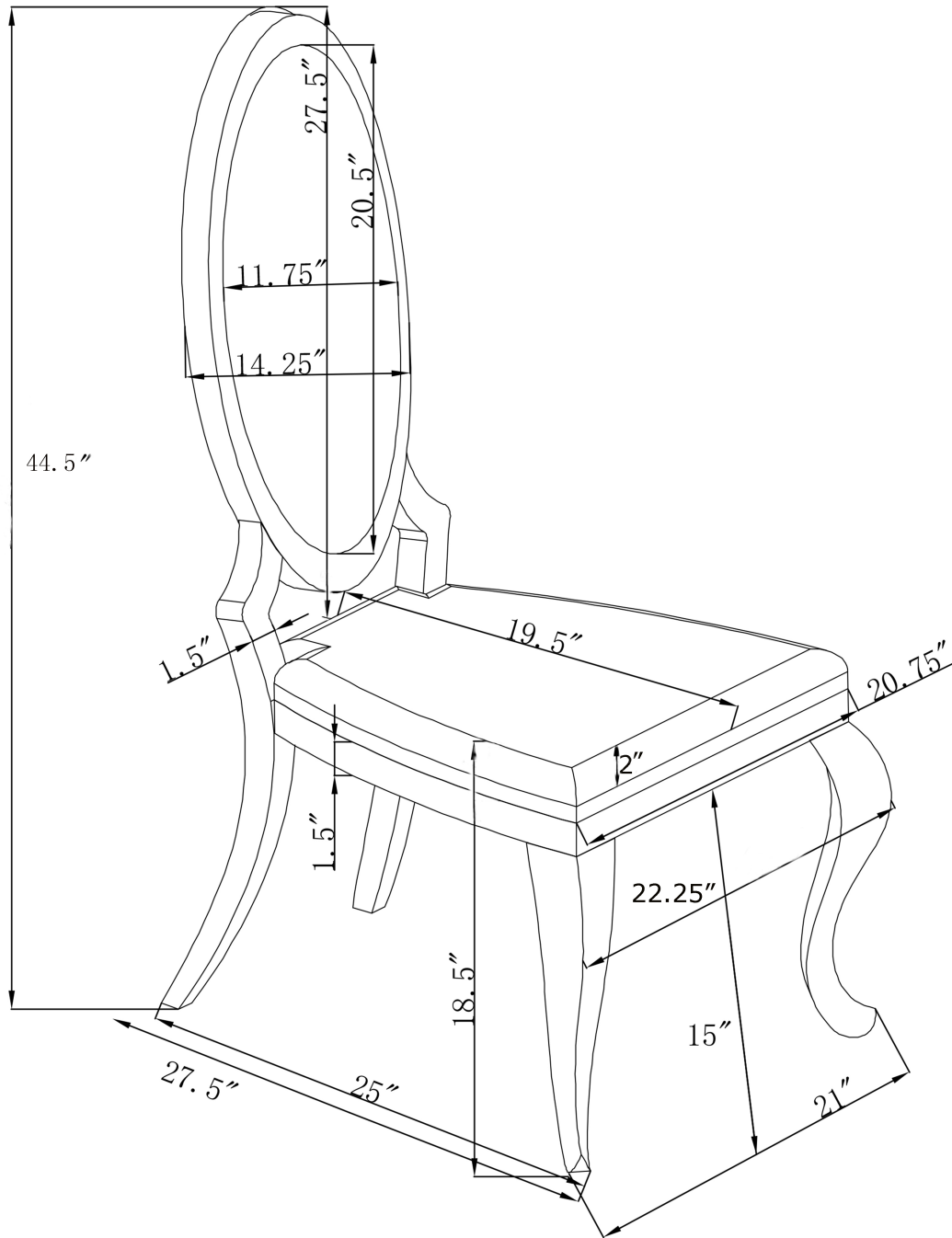

Note : Dimension tolerance $\pm 5\%$