

ASSEMBLY INSTRUCTIONS
COASTER FINE FURNITURE



Fine Furniture for every stage of life

301057
DAYBED

ITEM: 301057



ASSEMBLY INSTRUCTIONS

ASSEMBLY TIPS:

1. Remove hardware from box and sort by size.
2. Please check to see that all hardware and parts are present prior to start of assembly.
3. Please follow attached instructions in the same sequence as numbered to assure fast & easy assembly.



WARNING!



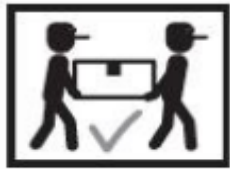

1. Don't attempt to repair or modify parts that are broken or defective. Please contact the store immediately.
2. This product is for home use only and not intended for commercial establishments.









ASSEMBLY TIME

25 MINUTES

PARTS IDENTIFICATION

A	LEFT SIDE		1PC	D	BACK SIDE		1PC
B	RIGHT SIDE		1PC	E	SLAT		20PCS
C	RAIL		2PCS				

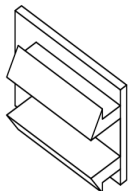
Z- HARDWARE IDENTIFICATION

1	BOLT(M8x20MM)		8PCS	5	ALLEN WRENCH		1PC
2	BOLT(M6x55MM)		2PCS	6	PLASTIC WASHER		4PCS
3	BOLT(M6x45MM)		2PCS	7	SLAT LOCKING CAP		40PCS
4	CURVED WASHER		4PCS				

Hardware pack is located in 301057 B1

ITEM: 301057

ASSEMBLY INSTRUCTION





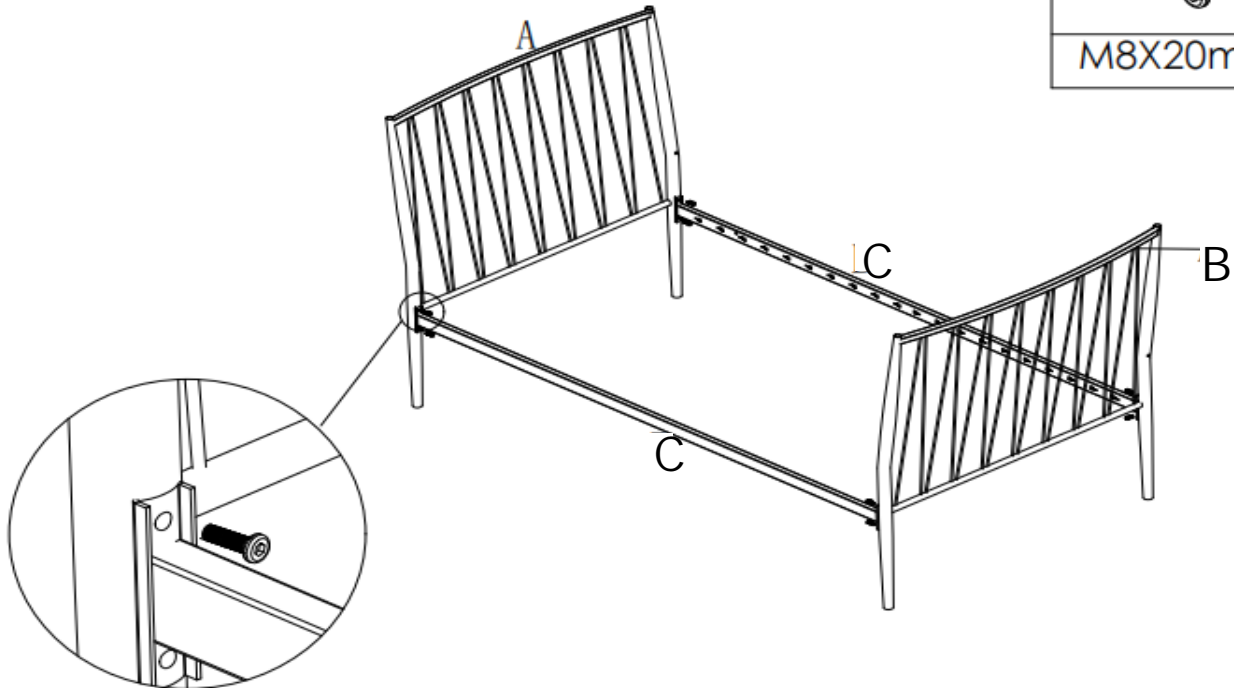

Step 1

1	X 8
	
M8X20mm	



Step 2

3	X 2	6	X 4
			
M6X45			
2	X 2	4	X 4
			
M6X55		Ø18XØ6.5	

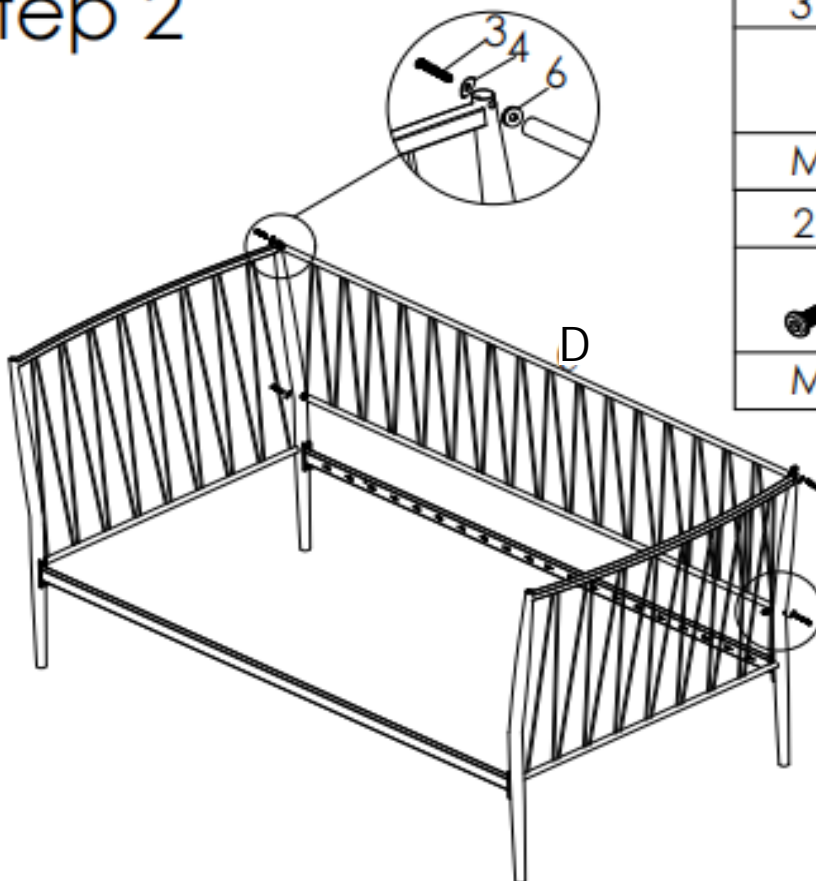

Step 3

SLAT INSTALLATION

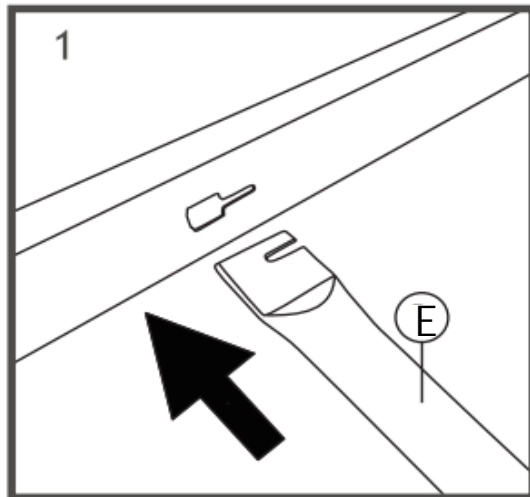

1. Insert slats into the hole on rail in the correct direction.

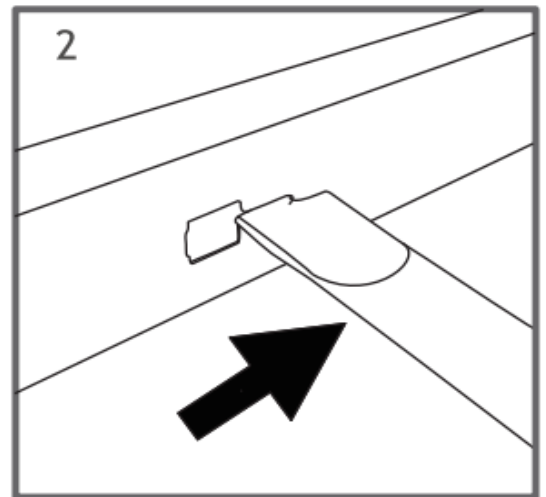

2. Push the slats into the gaps.

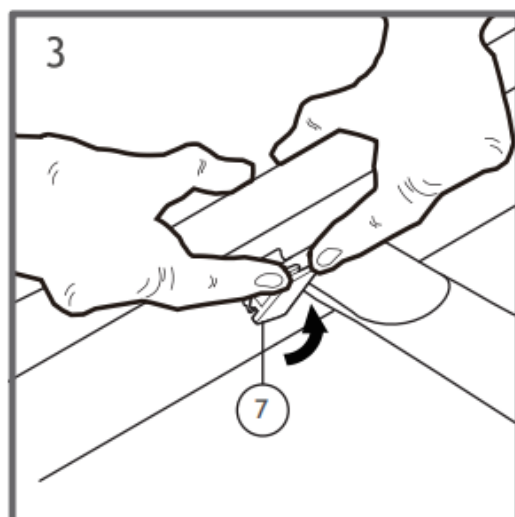

3. Put the slat locking cap into the lower part of the hole on 45 degree.

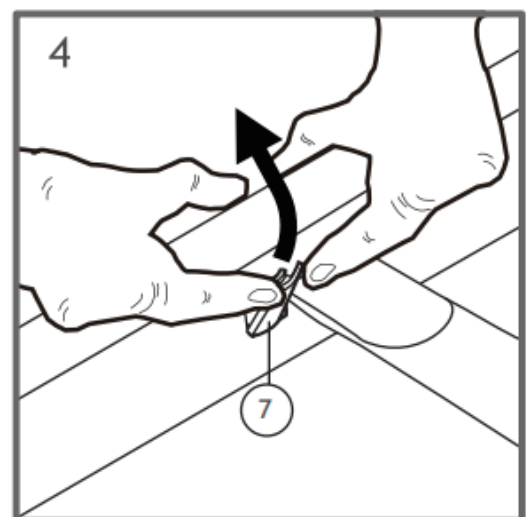

4. Press tight the upper part of slat locking cap to fix its position.

ITEM: 301057

ASSEMBLY INSTRUCTION



Step 4

7	X 40

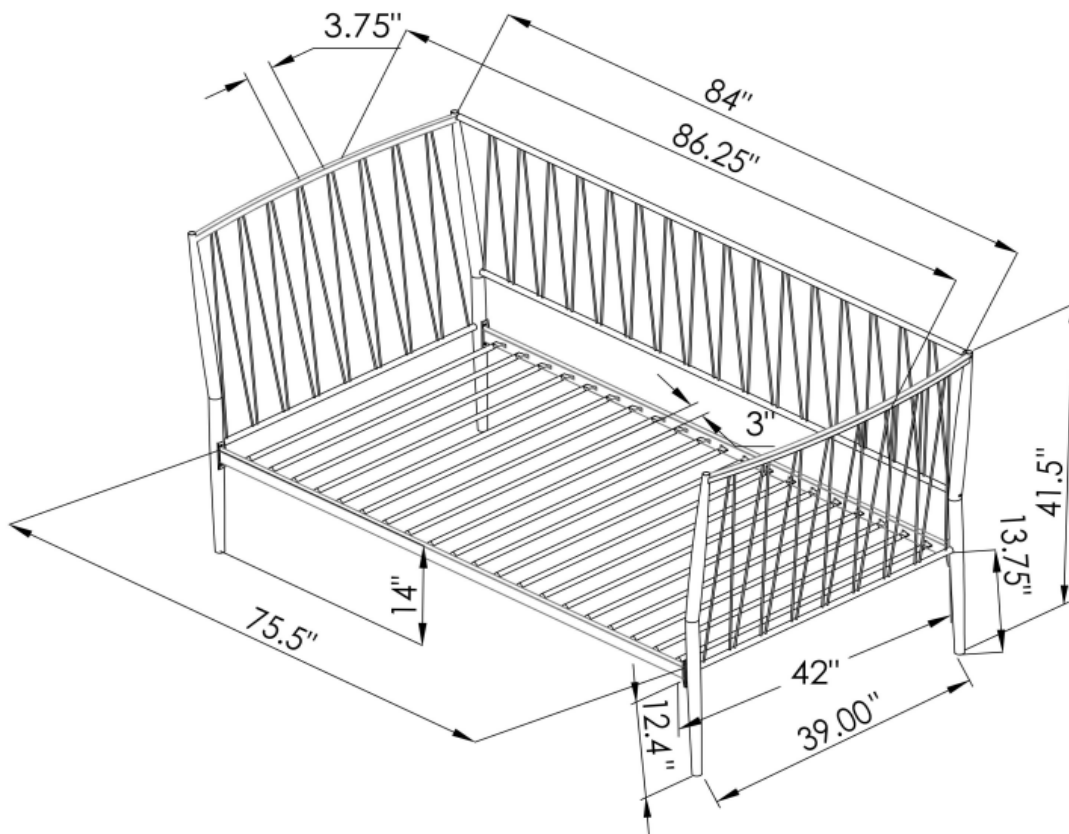
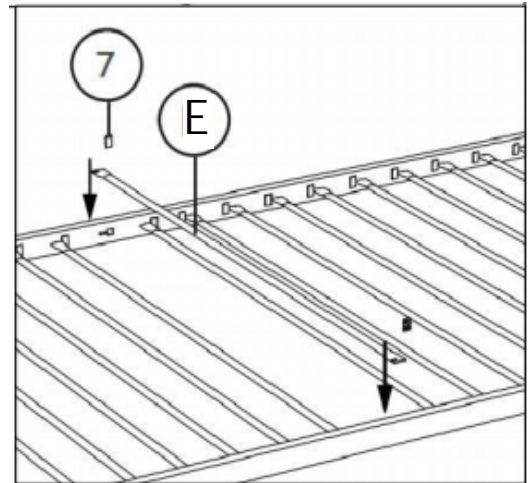
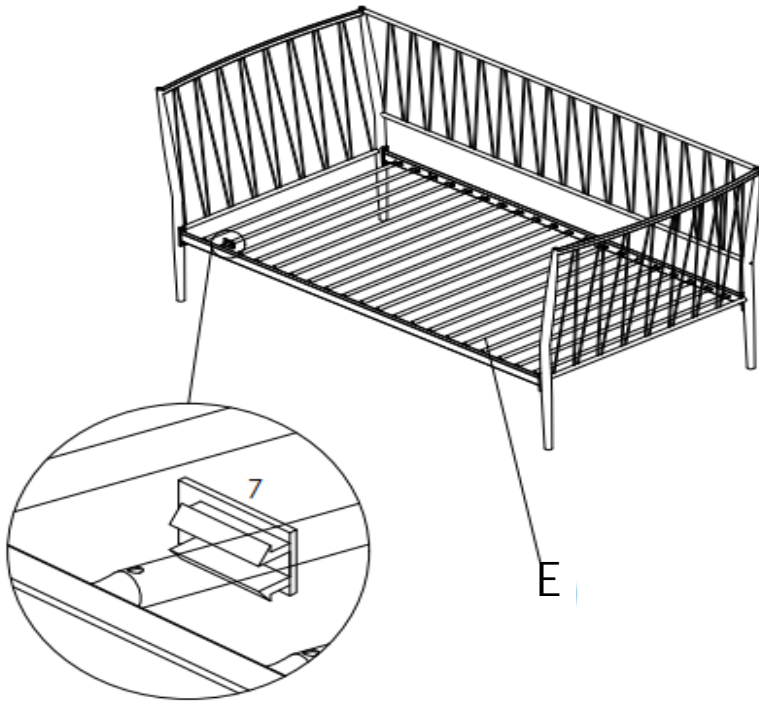

Note : Dimension tolerance $\pm 5\%$

