



ASSEMBLY INSTRUCTIONS COASTER FINE FURNITURE



Fine Furniture for every stage of life

190152

SIDE CHAIR

REVISION 0: 05/21/2019
REVISION 1: 03/29/2019
REVISION 2: 07/28/2022
REVISION 3: 12/25/2024

PAGE 1 OF 4

COASTERFURNITURE.COM

ITEM:190152



ASSEMBLY INSTRUCTIONS

ASSEMBLY TIPS:

1. Remove hardware from box and sort by size.
2. Please check to see that all hardware and parts are present prior to start of assembly.
3. Please follow attached instructions in the same sequence as numbered to assure fast & easy assembly.



WARNING!

1. Don't attempt to repair or modify parts that are broken or defective. Please contact the store immediately.
2. This product is for home use only and not intended for commercial establishments.



ASSEMBLY TIME

10 MINUTES

PARTS IDENTIFICATION

A		BACK	1PC
B		SEAT CUSHION	1PC
C		FRONT LEGS	2PCS

HARDWARE IDENTIFICATION

1		LARGE BOLT (M8×75mm)	4PCS
2		SMALL BOLT (M8×65mm)	4PCS
3		SMALL BOLT (M8×55mm)	1PC
4		ALLEN KEY (M8)	1PC
5		LOCK WASHER (Φ8)	9PCS
6		FLAT WASHER (Φ8)	9PCS

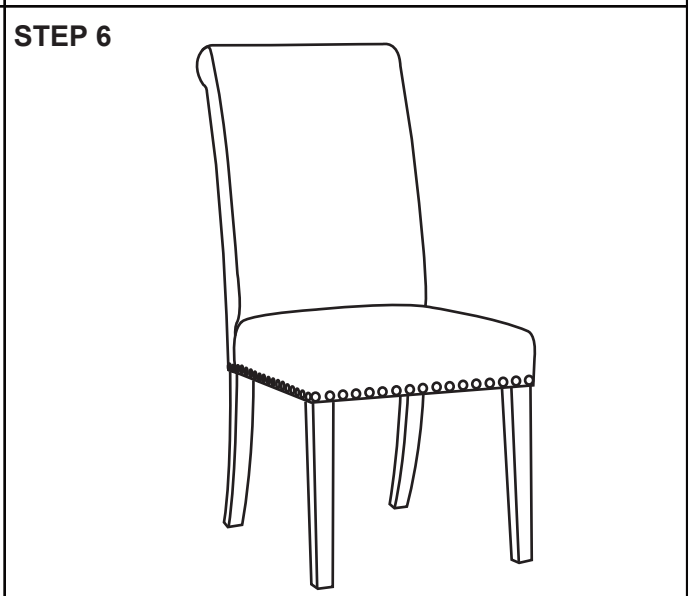
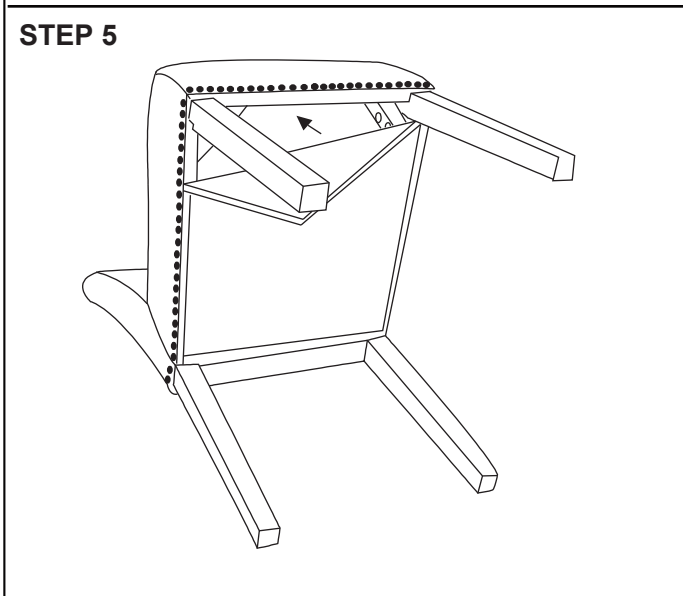
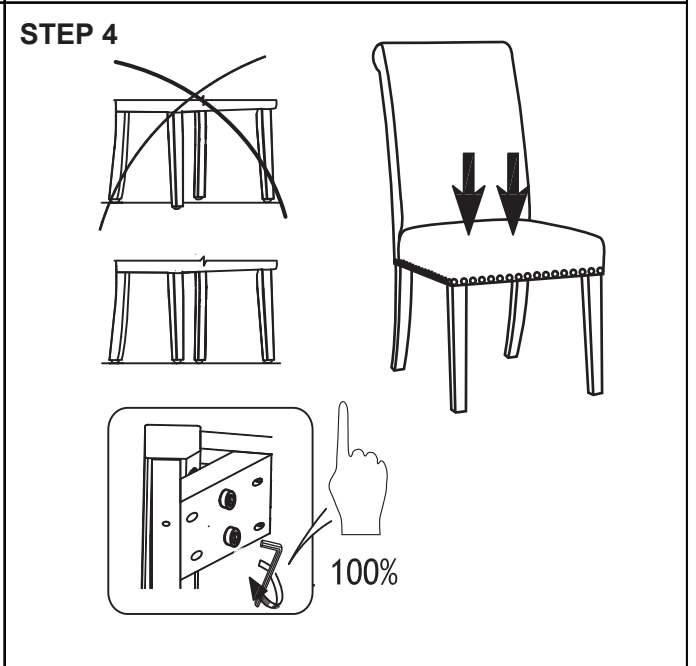
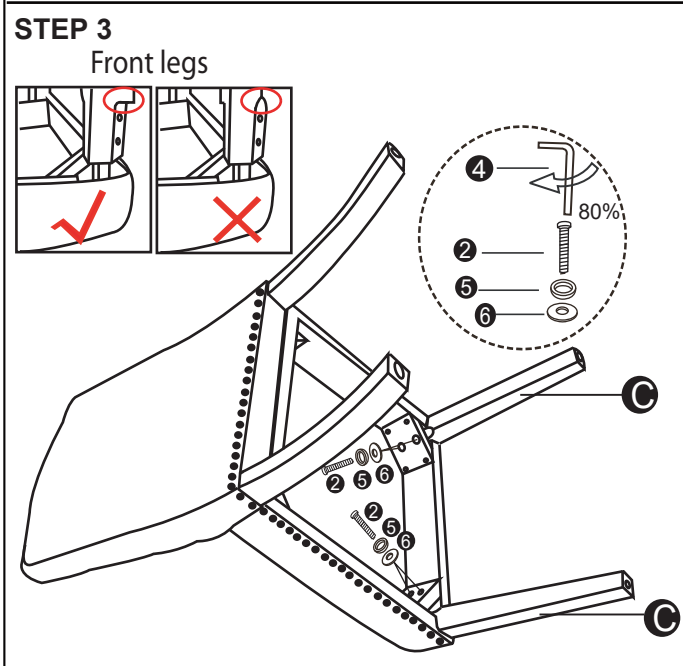
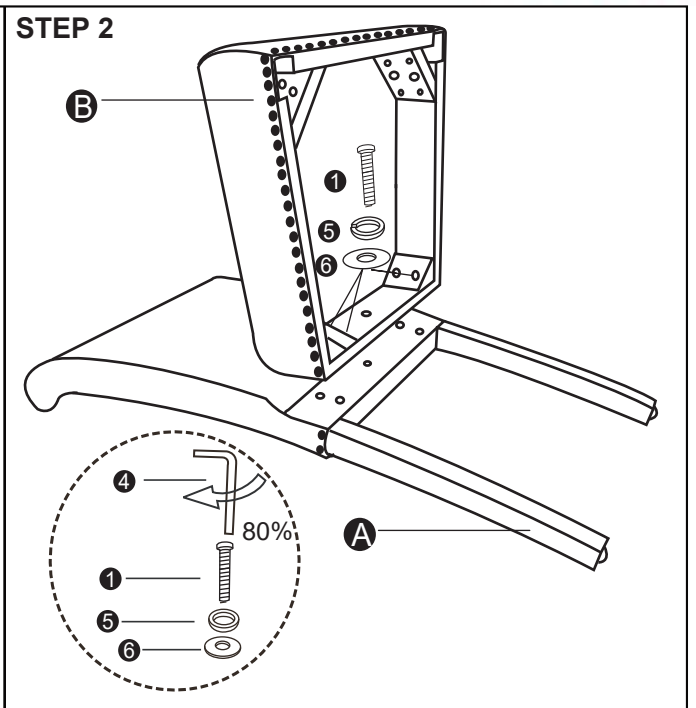
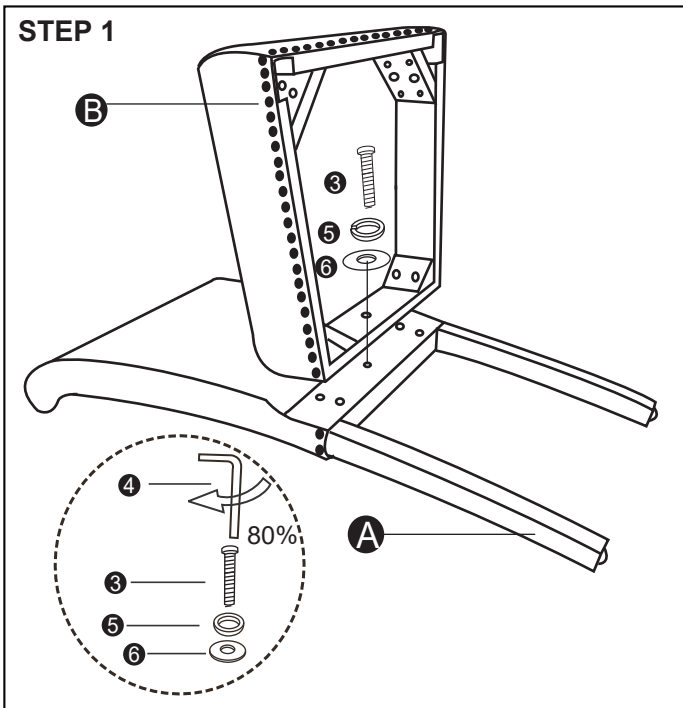

ITEM: **190152**



ASSEMBLY INSTRUCTIONS

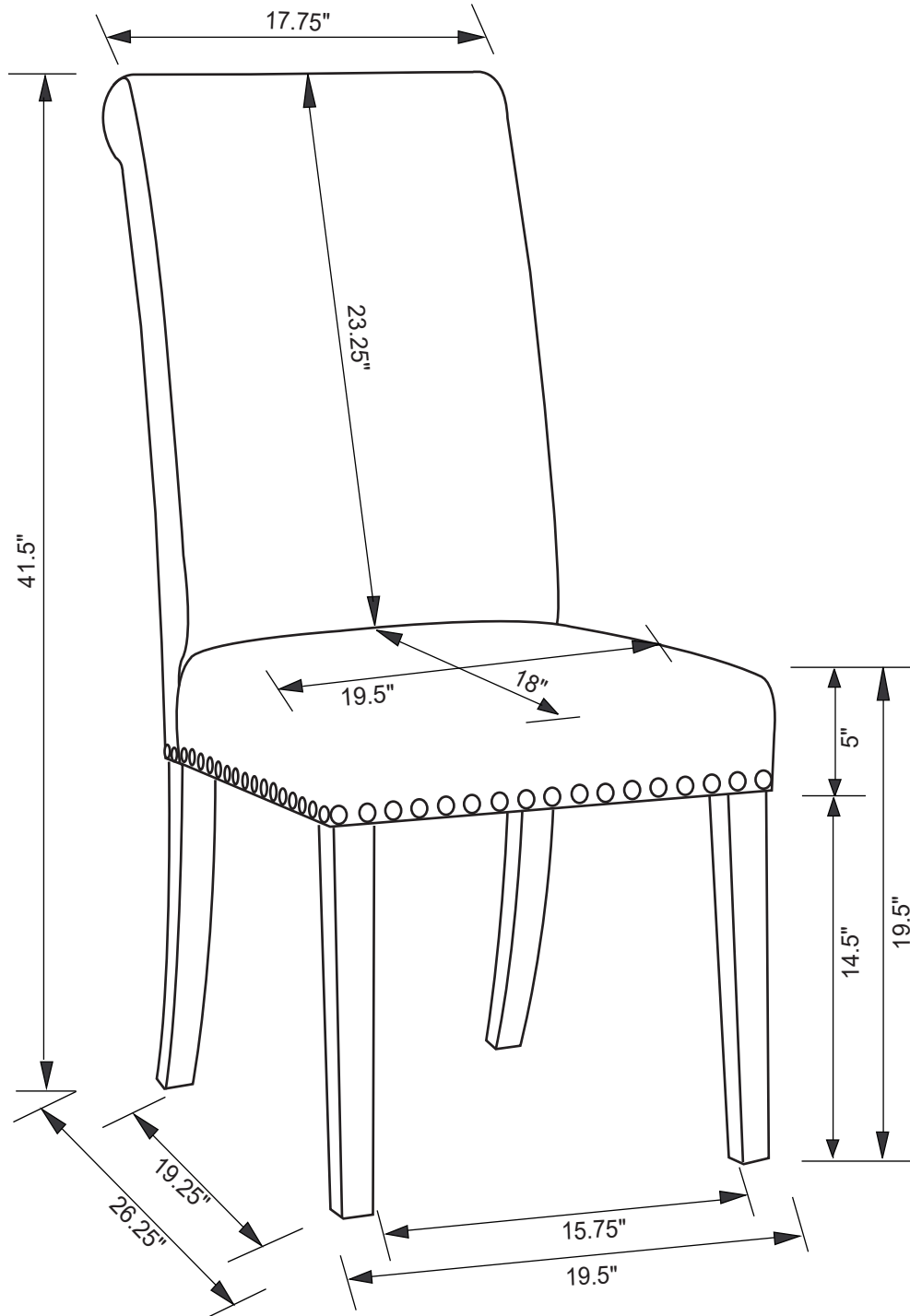

Note : Dimension tolerance $\pm 5\%$