



ASSEMBLY INSTRUCTIONS  
*COASTER FINE FURNITURE*



*Fine Furniture for every stage of life*

603436PPP  
POWER SWIVEL GLIDER RECLINER

ITEM :603436PPP

## ASSEMBLY INSTRUCTIONS



### ASSEMBLY TIPS:

- 1.Remove hardware from box and sort by size.
- 2.Please check to see that all hardware and parts are present prior to start of assembly.
- 3.Please follow attached instruction in the same sequence as numbered to assure fast & easy assembly.



#### WARNING!

- 1.Don't attempt to repair or modify parts that are broken or defective. Please contact the store immediately.
- 2.This product is for home use only and not intended for commercial establishment.



ASSEMBLY TIME

5 MINUTES

## PARTS IDENTIFICATION

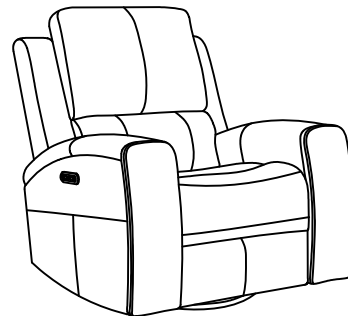
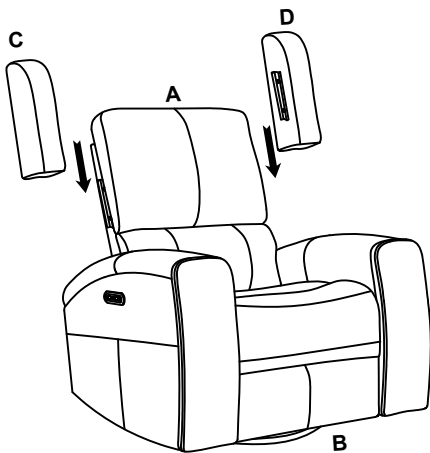

**A BACK**



**1 PC**

**B BASE**



**1 PC**

**C LEFT EAR**



**1 PC**

**D RIGHT EAR**



**1 PC**

**E POWER CORD**



**1 PC**

**F ADAPTER WITH BAT. BACKUP**



**1 PC**

ITEM :603436PPP

ASSEMBLY INSTRUCTIONS



STEP 1

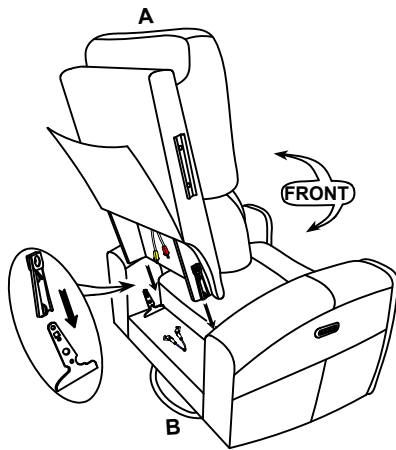

STEP 2

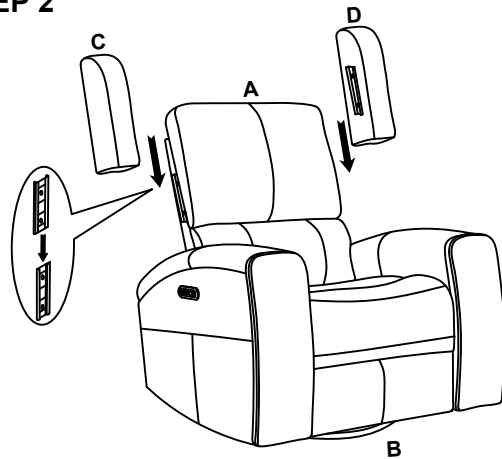

STEP 3

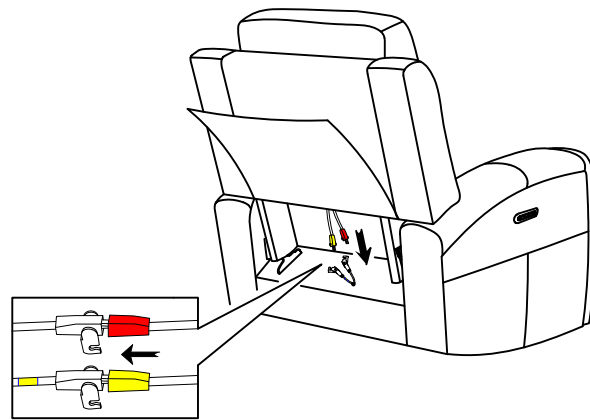

STEP 4

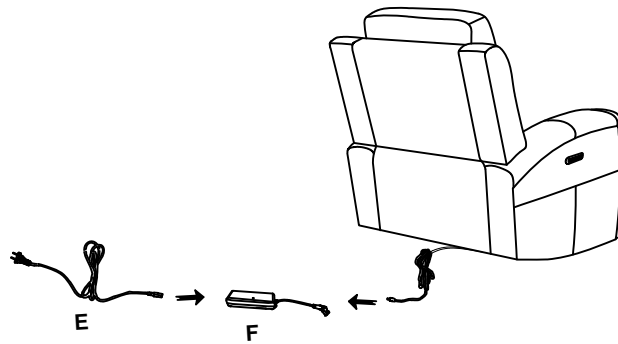

STEP 5

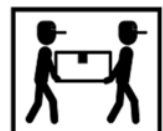
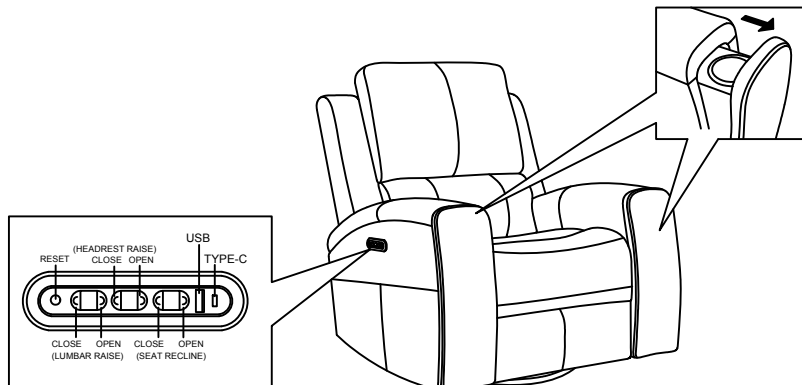

ITEM :603436PPP

ASSEMBLY INSTRUCTIONS



Please follow below steps to install the 9V batteries when there is no power to operate the motion sofa.(Any model of 9V battery is applicable)

STEP 1

Open the marked battery door on the backup battery box.

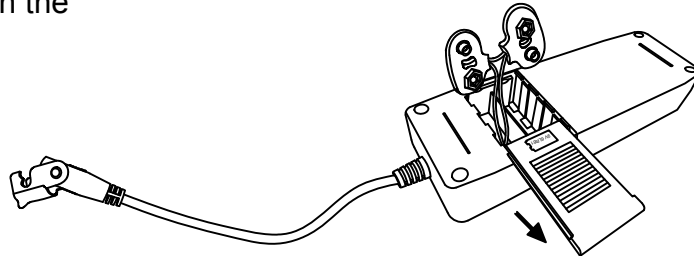

STEP 2

Install two 9V batteries in the backup battery box.(batteries are not included)

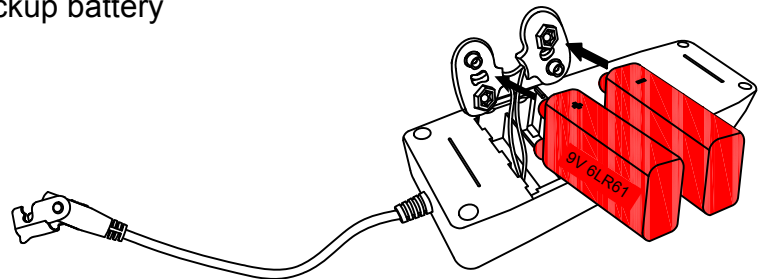

STEP 3

Push the batteries in.

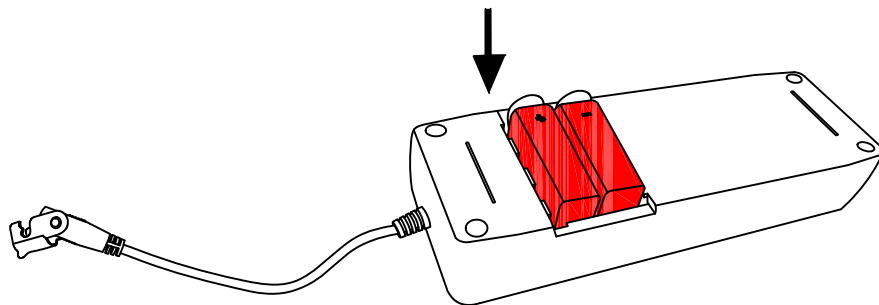

STEP 4

Close the box door.

Notice: Please don't keep the battery in the box when the power motion sofa is under daily use with power supply.

