



*ASSEMBLY INSTRUCTIONS
COASTER FINE FURNITURE*



Fine Furniture for every stage of life

600537P(B1&B2)
Sleeper Sofa Bed

ITEM: 600537P (B1&B2)



ASSEMBLY INSTRUCTIONS

ASSEMBLY TIPS:

1. Remove hardware from box and sort by size.
2. Please check to see that all hardware and parts are present prior to start of assembly.
3. Please follow attached instructions in the same sequence as numbered to assure fast & easy assembly.



WARNING!

1. Don't attempt to repair or modify parts that are broken or defective. Please contact the store immediately.
2. This product is for home use only and not intended for commercial establishments.



ASSEMBLY TIME

15 MINUTES

PARTS IDENTIFICATION

B1 (BOX 1)

A	BACKREST		1PC
D	BACK CUSHION		1PC
F	LEG		2PCS
H	CASTER		2PCS

B	LAF SEAT		1PC
E	PILLOW		2PCS
G	FOOT		4PCS

B2 (BOX 2)

A	BACKREST		1PC
D	BACK CUSHION		1PC
F	LEG		2PCS
H	CASTER		2PCS
J	ADAPTER		1PC

C	RAF SEAT		1PC
E	PILLOW		2PCS
G	FOOT		4PCS
I	CONNECTING WIRE		1PC
K	PLUG		1PC

ITEM: 600537P (B1&B2)



ASSEMBLY INSTRUCTIONS

ASSEMBLY TIPS:

1. Remove hardware from box and sort by size.
2. Please check to see that all hardware and parts are present prior to start of assembly.
3. Please follow attached instructions in the same sequence as numbered to assure fast & easy assembly.







WARNING!





1. Don't attempt to repair or modify parts that are broken or defective. Please contact the store immediately.
2. This product is for home use only and not intended for commercial establishments.

HARDWARE IDENTIFICATION

Z-B1 (BOX 1) - HARDWARE PACK IS LOCATED IN 600537P(B1)

1	PAN HEAD SCREW (#8 x 45mm - BLK)		8PCS
2	BOLT (1/4" x 20mm - BLK)		4PCS
3	FLAT WASHER (1/4" x 20mm - BLK)		4PCS
4	ALLEN WRENCH (M4 x 70mm - BLK)		1PC
5	BRACKET (M4 x 70mm - BLK)		2PCS

Z-B2 (BOX 2) - HARDWARE PACK IS LOCATED IN 600537P(B2)

1	PAN HEAD SCREW (#8 x 45mm - BLK)		8PCS
2	BOLT (1/4" x 20mm - BLK)		4PCS
3	FLAT WASHER (1/4" x 20mm - BLK)		4PCS
4	ALLEN WRENCH (M4 x 70mm - BLK)		1PC
5	BRACKET (M4 x 70mm - BLK)		2PCS

NOTE :

Phillips head screw driver is required in the assembly process. However, manufacturer does not provide this item.

ITEM: 600537P (B1&B2)

ASSEMBLY INSTRUCTIONS



STEP 1

HARDWARE PACK

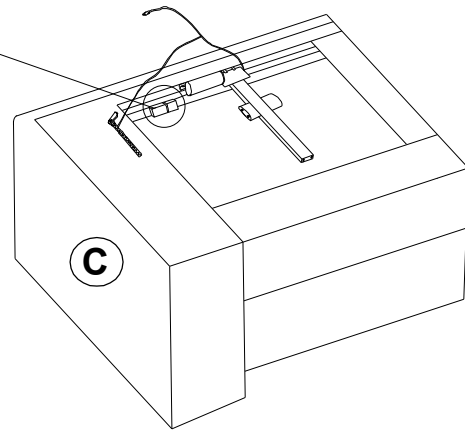
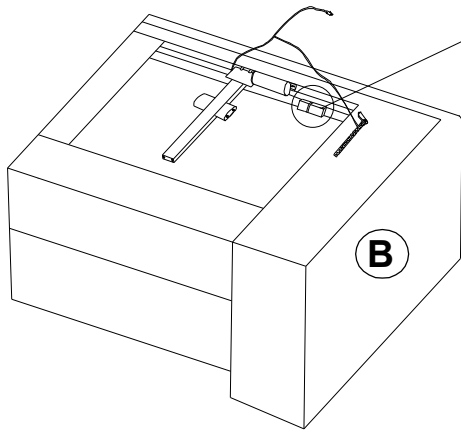

STEP 2

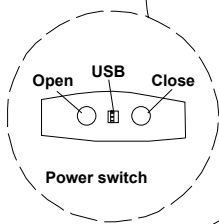
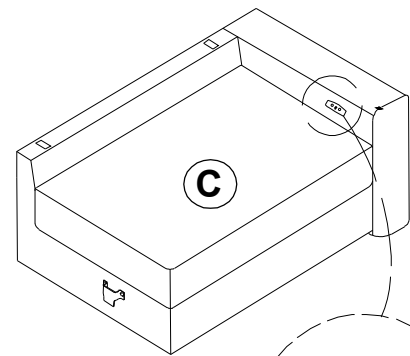
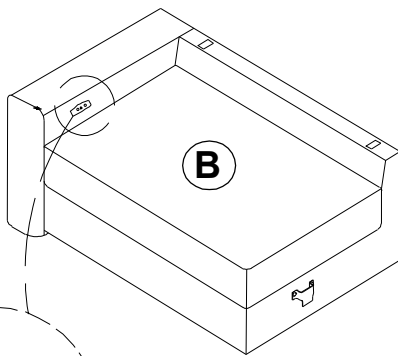

**When the power switch is turned on, the chair will automatically come out.

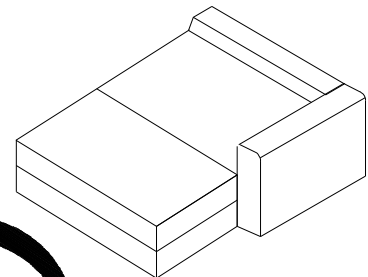
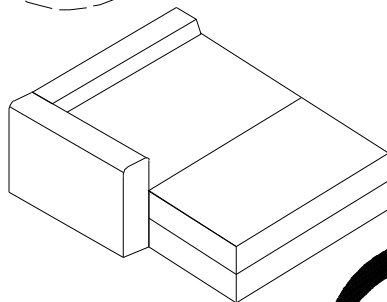
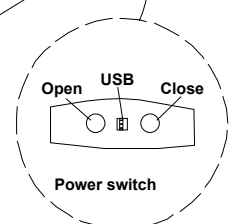

ITEM: 600537P (B1&B2)

ASSEMBLY INSTRUCTIONS



STEP 3

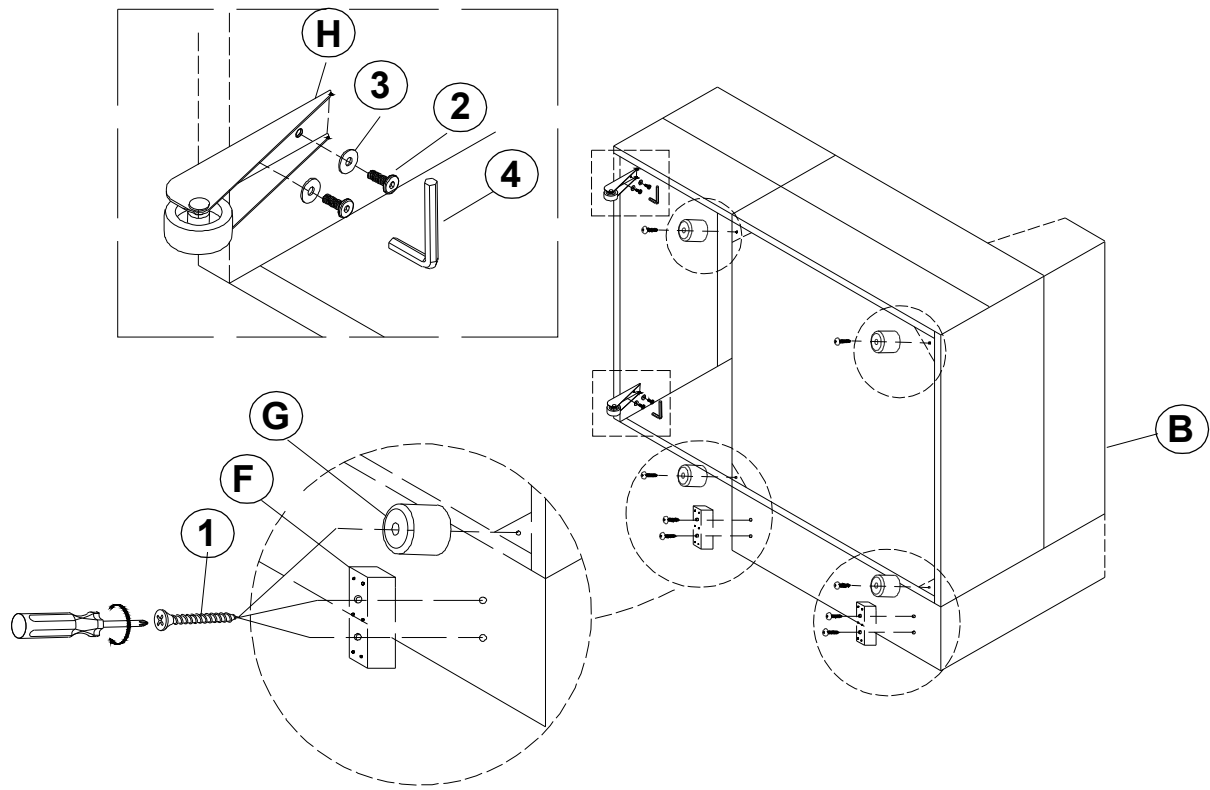

STEP 4

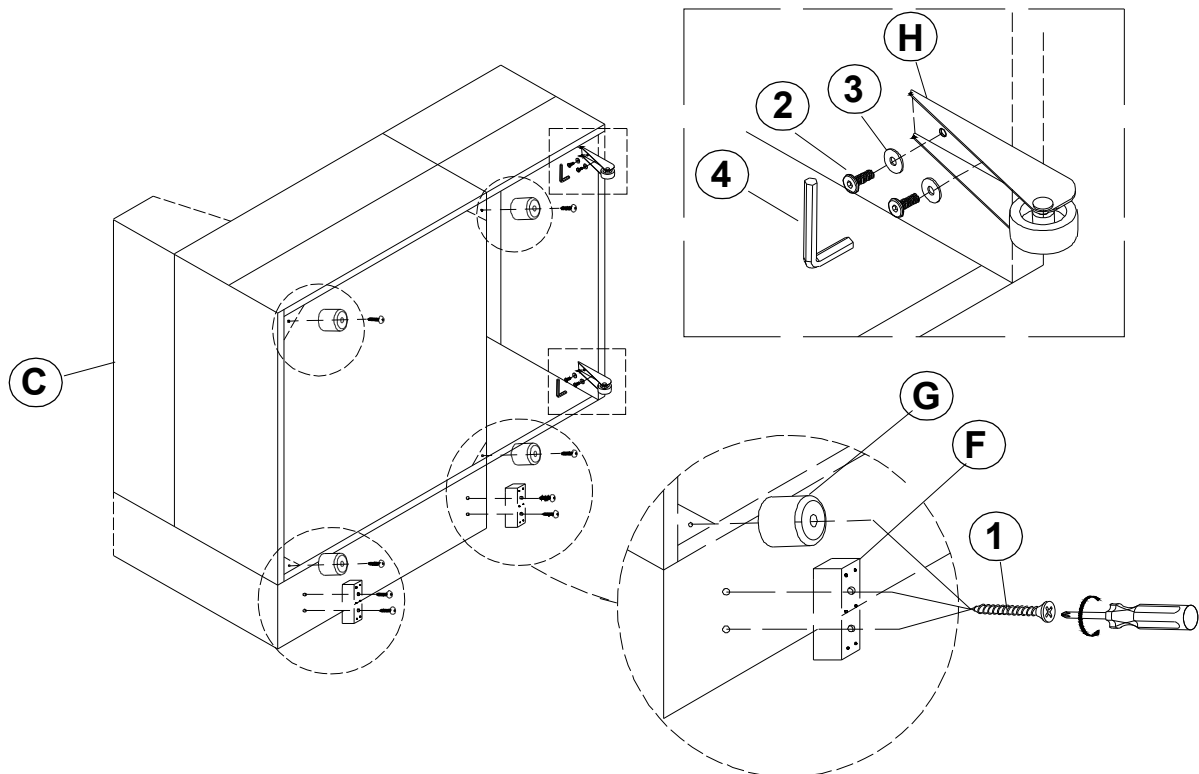

ITEM: 600537P (B1&B2)

ASSEMBLY INSTRUCTIONS



STEP 5

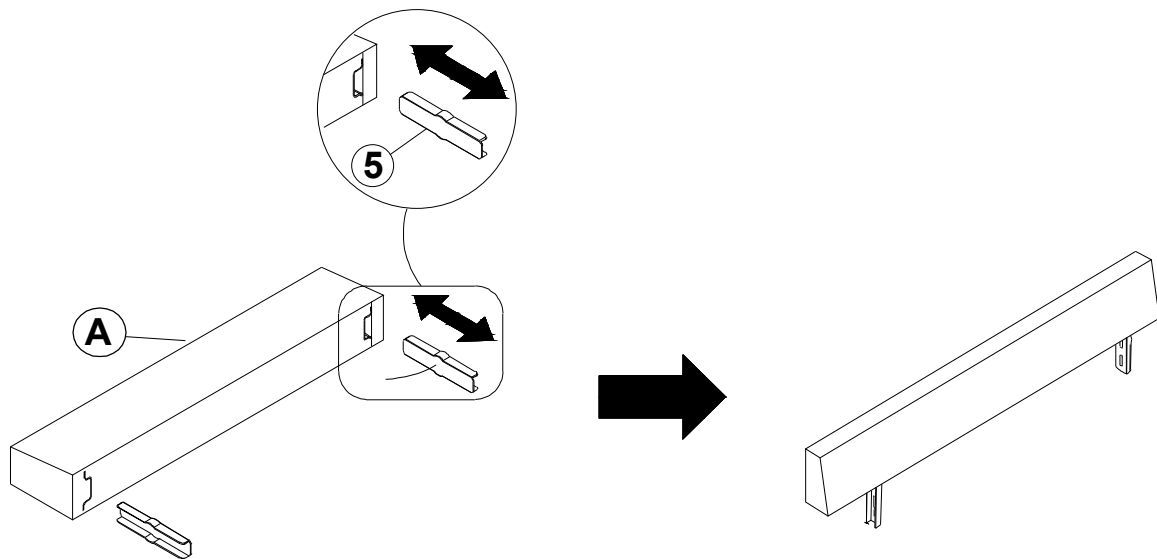

STEP 6

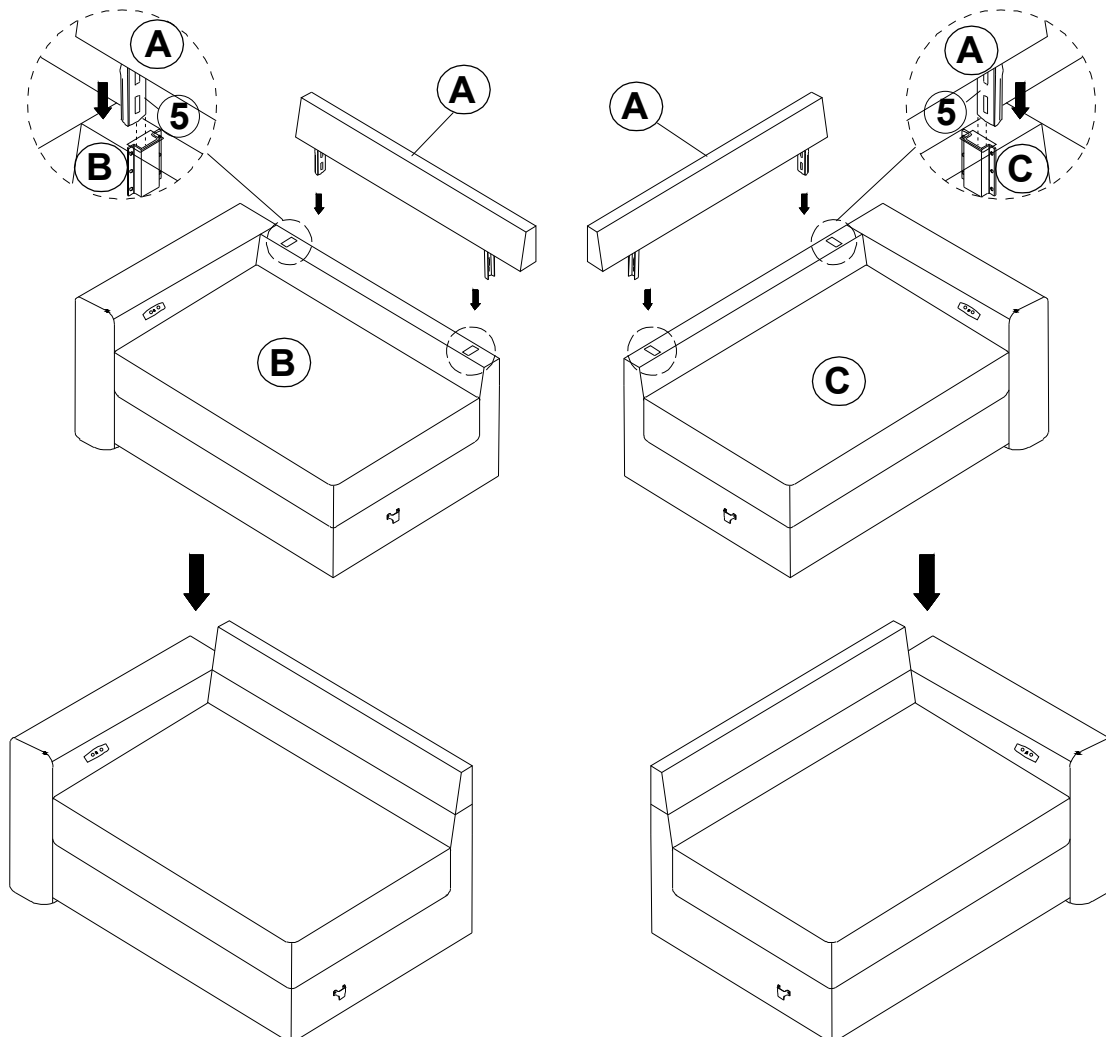

ITEM: 600537P (B1&B2)

ASSEMBLY INSTRUCTIONS



STEP 7

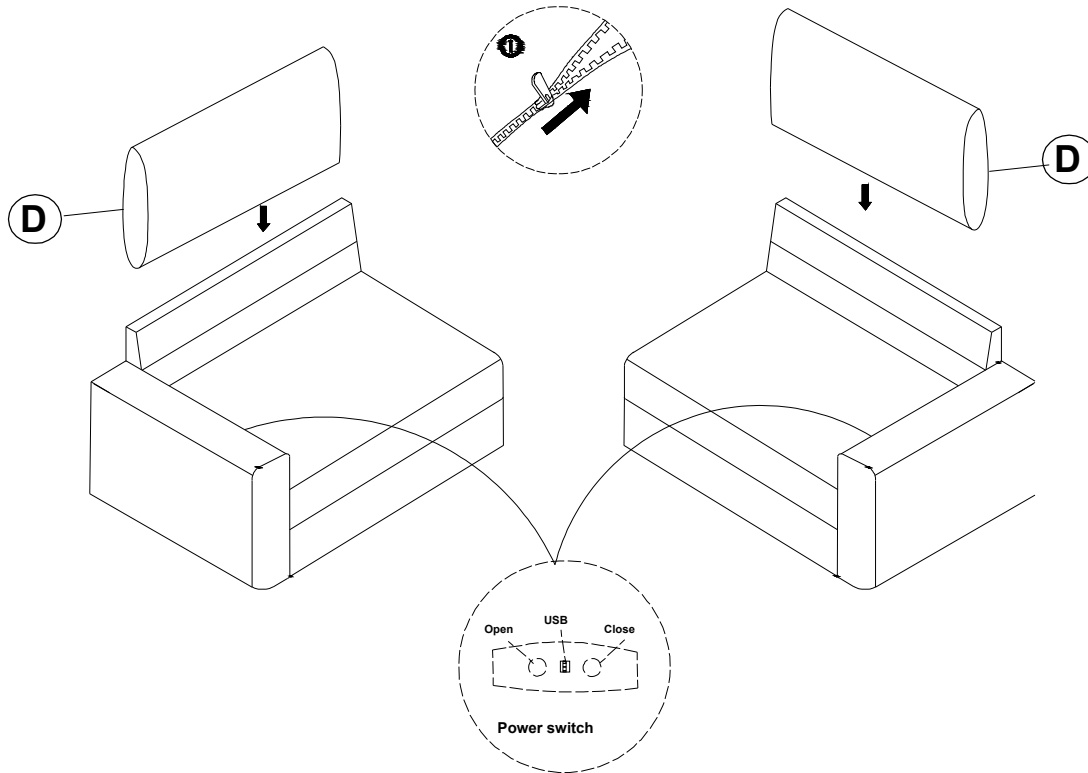

STEP 8

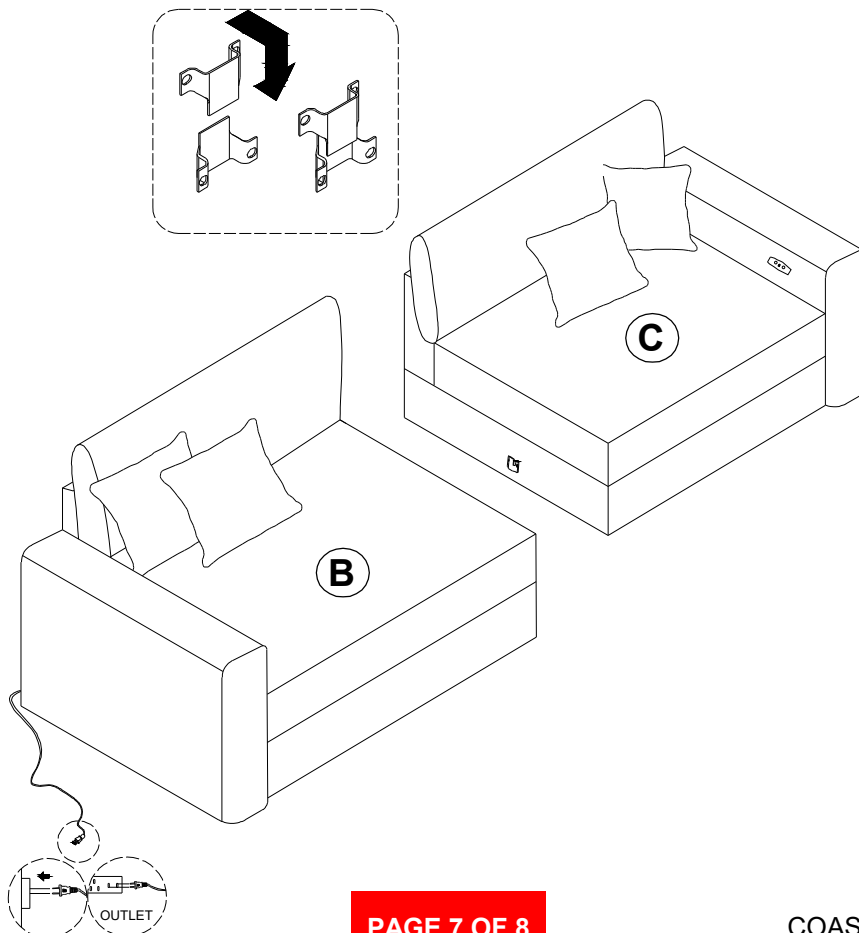

ITEM: 600537P (B1&B2)

ASSEMBLY INSTRUCTIONS

STEP 9 COMPLETE

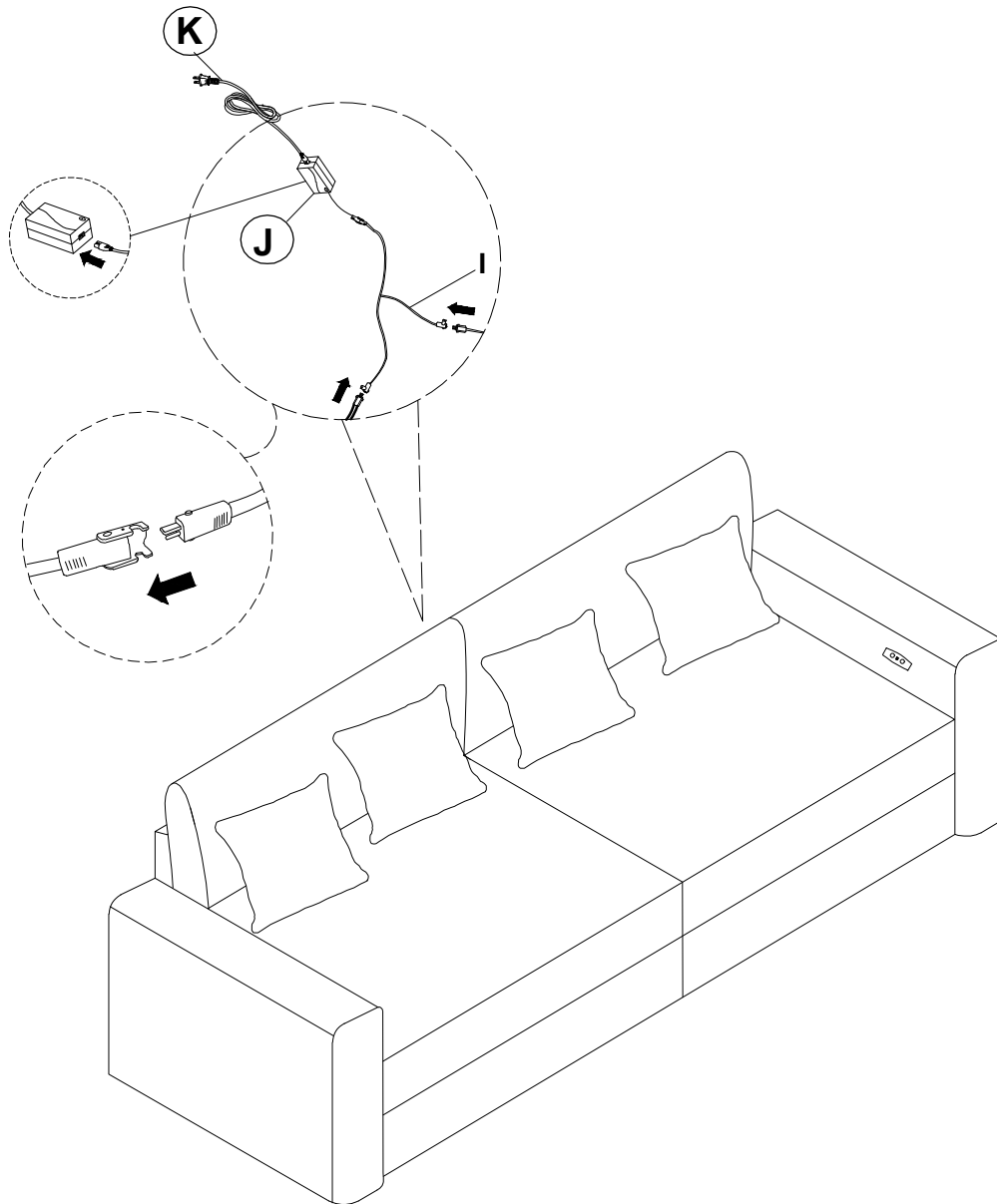

ITEM: 600537P (B1&B2)

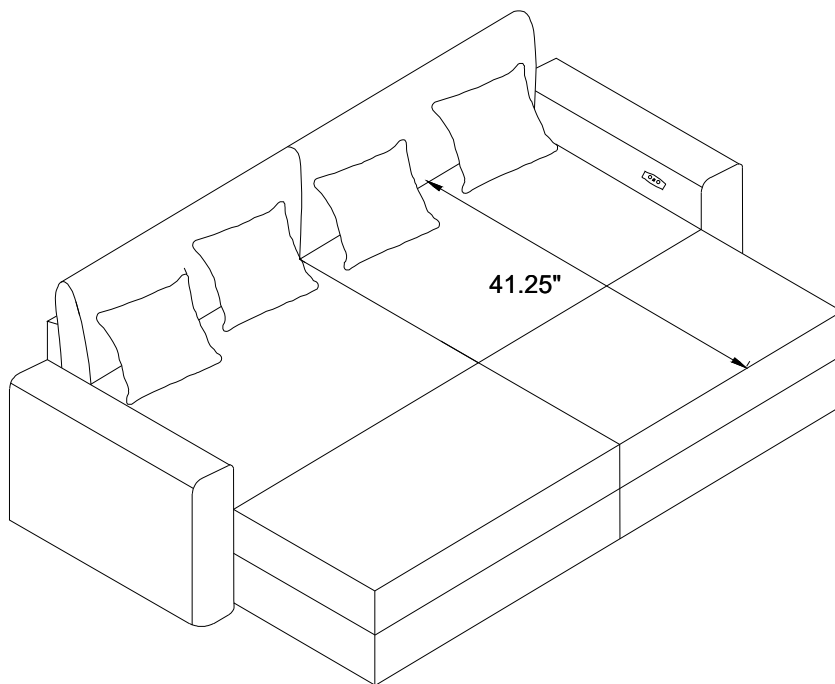
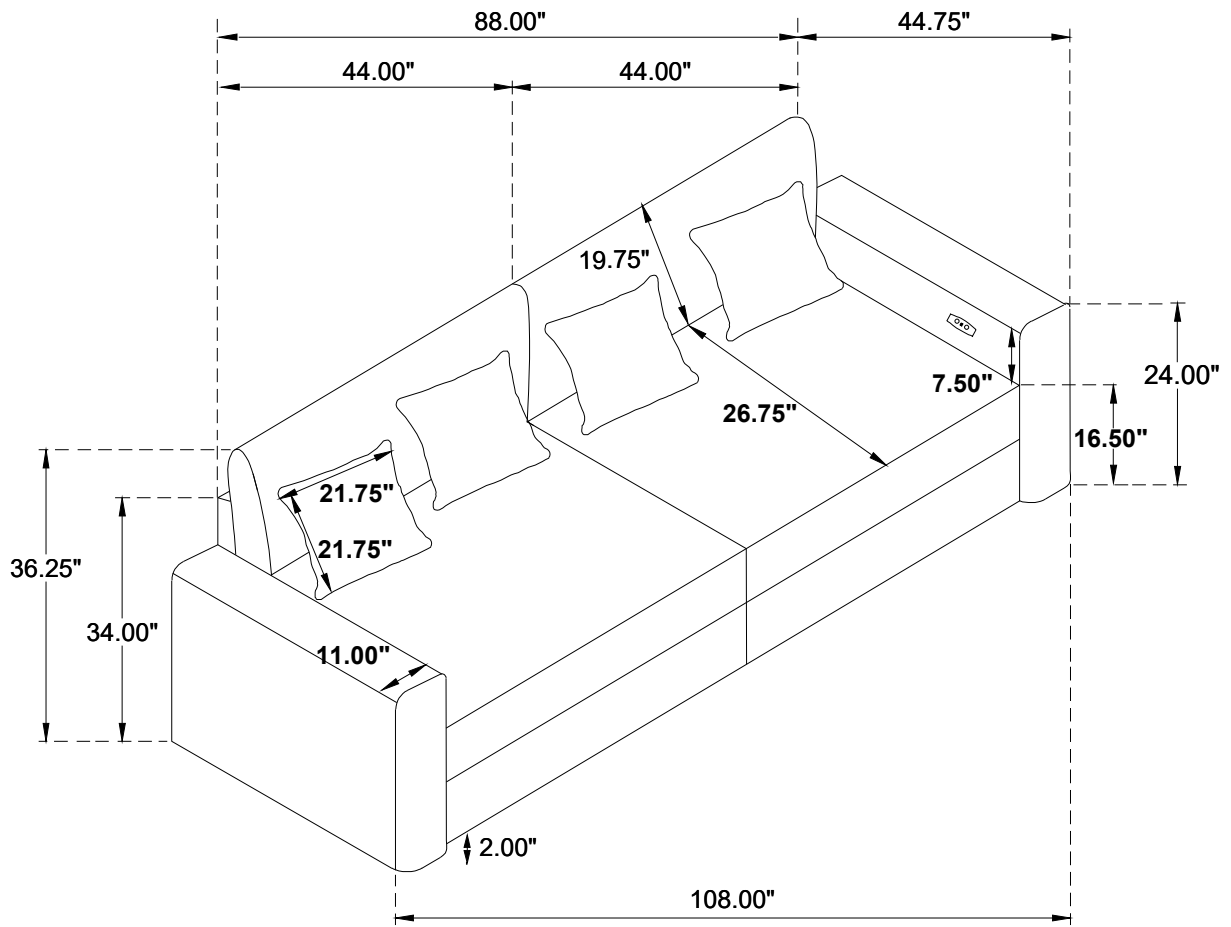

Note: Dimension tolerance $\pm 5\%$