



ASSEMBLY INSTRUCTIONS

COASTER FINE FURNITURE



Fine Furniture for every stage of life

610453P
Power Lift Recliner

ITEM: **610453P**



ASSEMBLY INSTRUCTIONS

ASSEMBLY TIPS:

- 1.Remove hardware from box and sort by size.
- 2.Please check to see that all hardware and parts are present prior to start of assembly.
- 3.Please follow attached instructions in the same sequence as numbered to assure fast & easy assembly.



WARNING

- 1.Don't attempt to repair or modify parts that are broken or defective. Please contact the store immediately.
- 2.This product is for home use only and not intended for commercial establishments.



ASSEMBLY TIME

5 MINUTES

PARTS IDENTIFICATION

A SEAT



1PC

B BACK



1PC

CF MOTOR CABLE



1PC

E ADAPTER



1PC

ITEM: **610453P**
ASSEMBLY INSTRUCTIONS



STEP 1

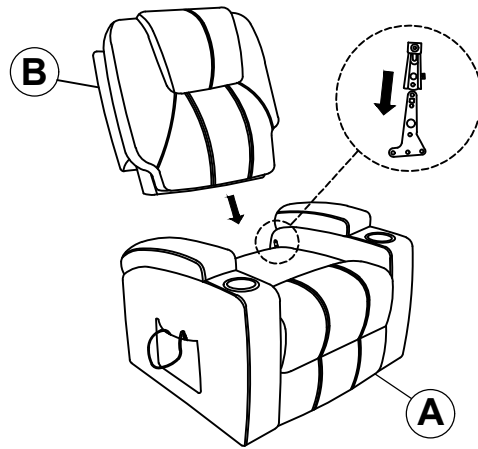

STEP 2

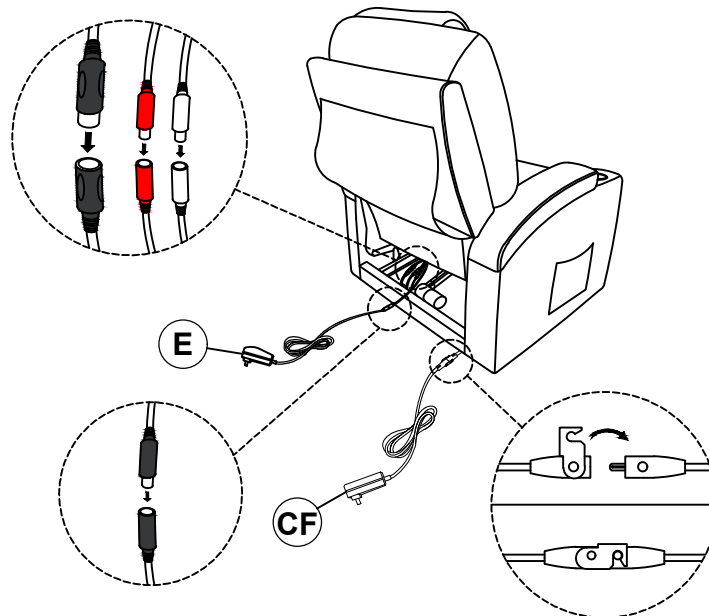

STEP 3

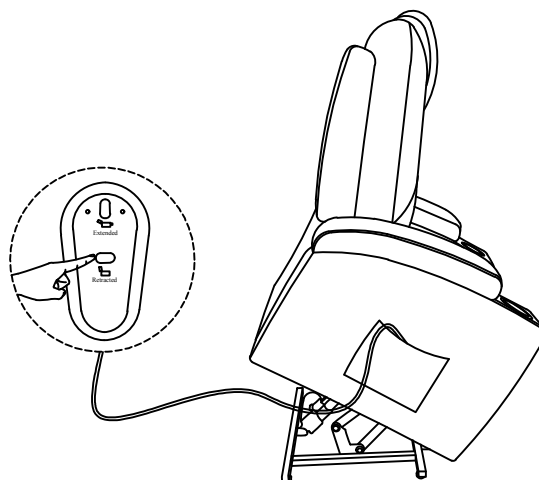

ITEM: **610453P**
ASSEMBLY INSTRUCTIONS
STEP 4

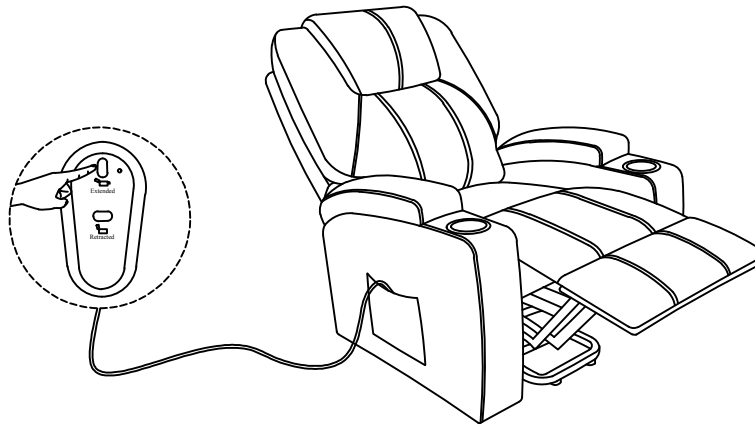

STEP 5



STEP 6
COMPLETE

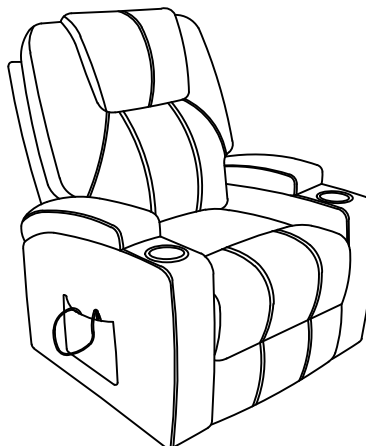

ITEM: **610453P**

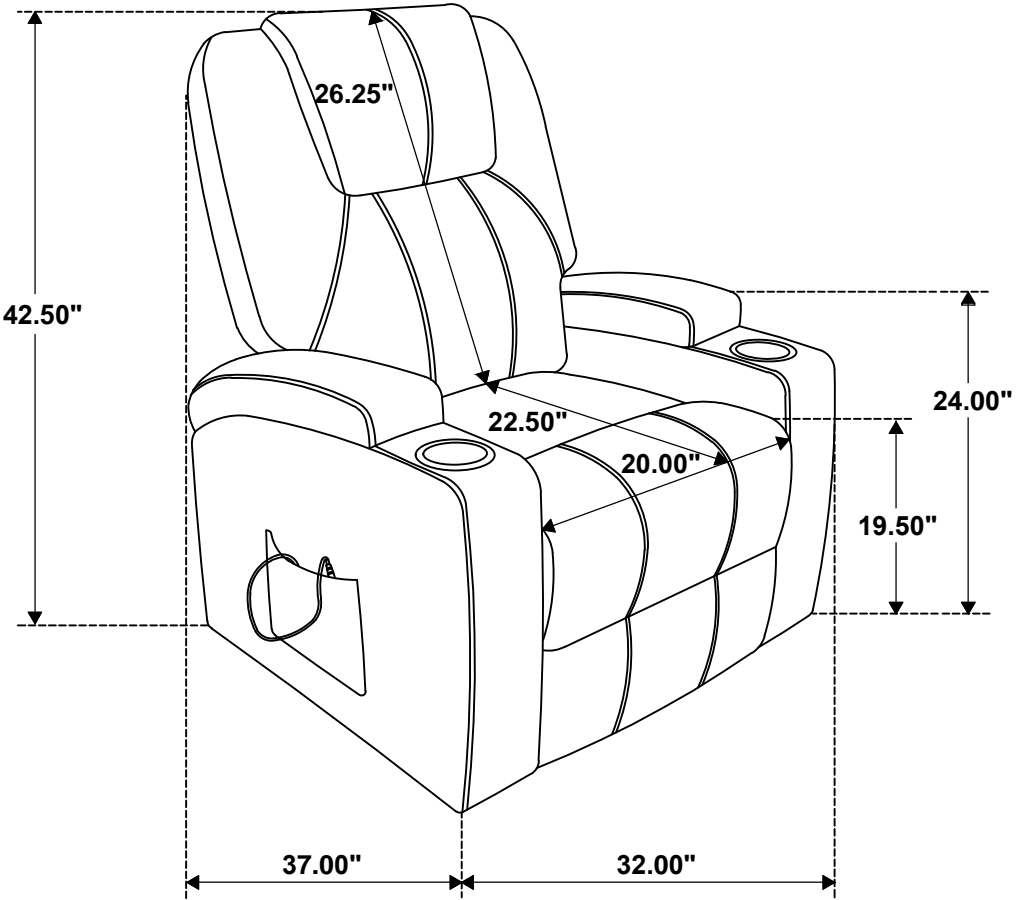

Note: Dimension tolerance ±5%