



ASSEMBLY INSTRUCTIONS COASTER FINE FURNITURE



Fine Furniture for every stage of life

551892
CORNER

ITEM: 551892



ASSEMBLY INSTRUCTIONS

ASSEMBLY TIPS:

1. Remove hardware from box and sort by size.
2. Please check to see that all hardware and parts are present prior to start of assembly.
3. Please follow attached instructions in the same sequence as numbered to assure fast & easy assembly.



WARNING !

1. Don't attempt to repair or modify parts that are broken or defective. Please contact the store immediately.
2. This product is for home use only and not intended for commercial establishments.



ASSEMBLY TIME

10 MINUTES

PARTS IDENTIFICATION

A. CORNER BASE

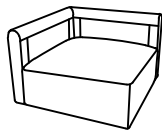

1PC

B. LEG



4PCS

C. CORNER LEFT
BACK CUSHION



1PC

D. CORNER RIGHT
BACK CUSHION



1PC

E. PILLOW

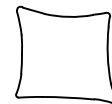

1PC

ITEM: **551892**
ASSEMBLY INSTRUCTIONS



STEP 1

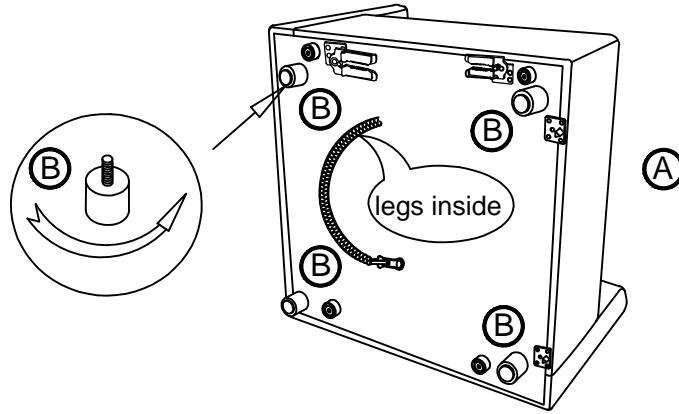

STEP 2

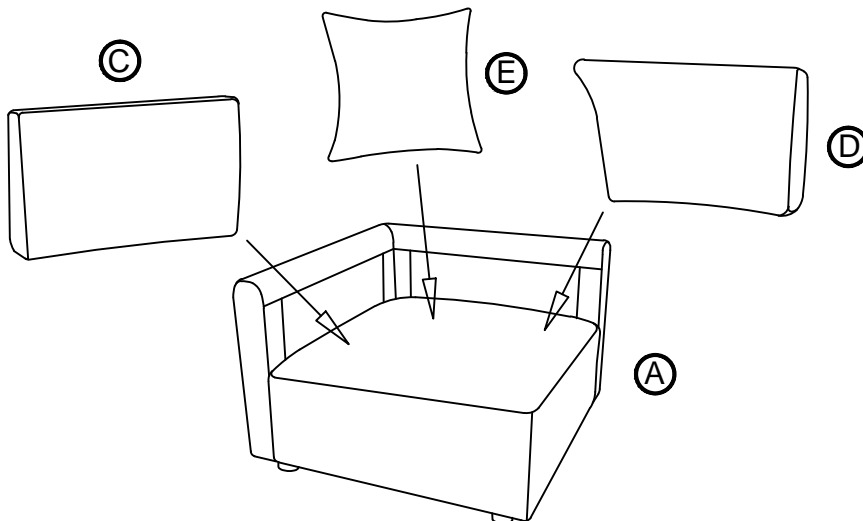

STEP 3

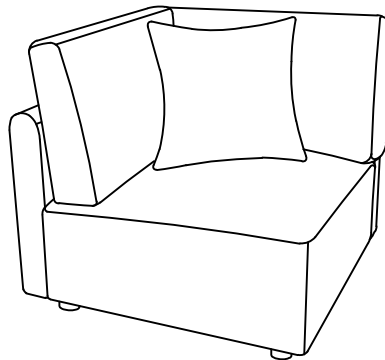

ITEM: 551894LAF/551891/551892/551894RAF
ASSEMBLY INSTRUCTIONS

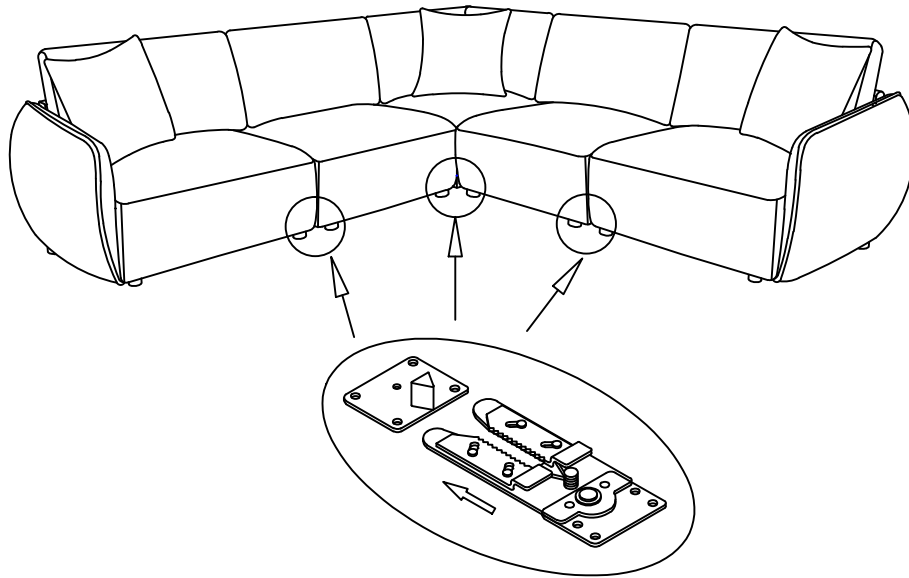

1

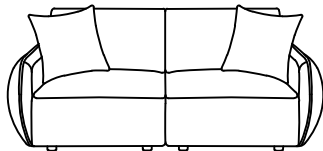

2

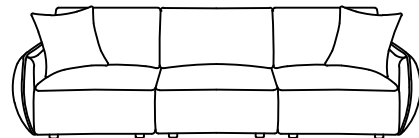

3

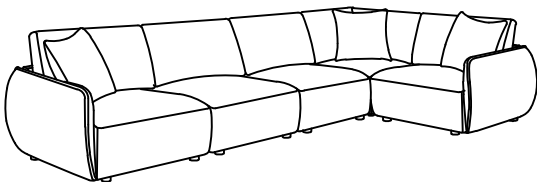

4

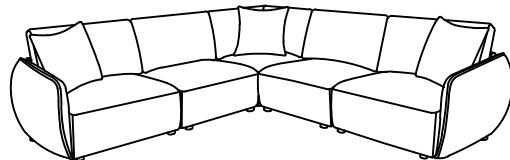

5

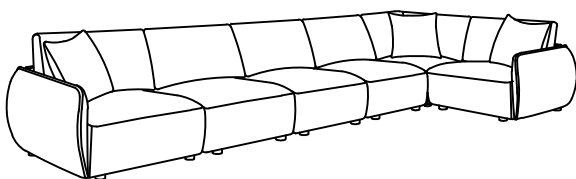

6

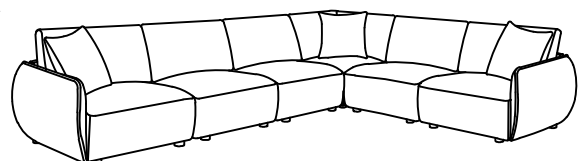

ITEM: **551892**
ASSEMBLY INSTRUCTIONS

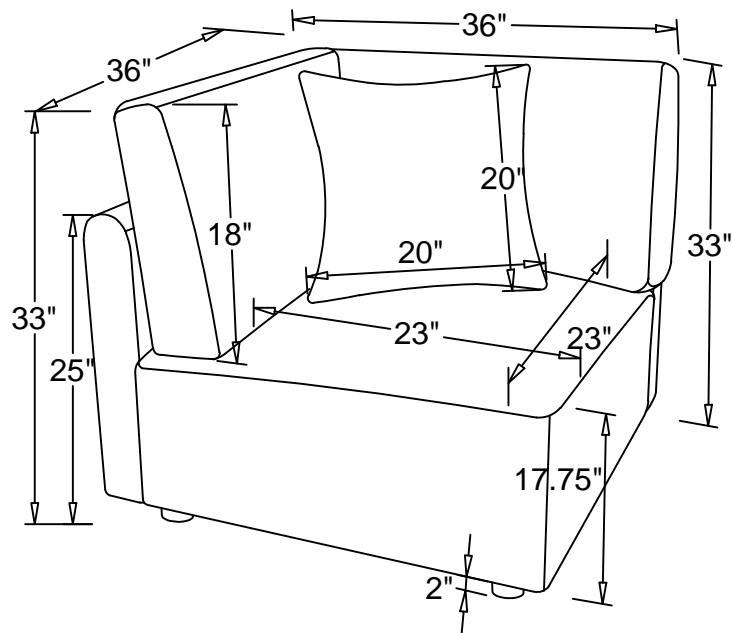

Note: Dimension tolerance $\pm 5\%$

