

ITEM: 753277

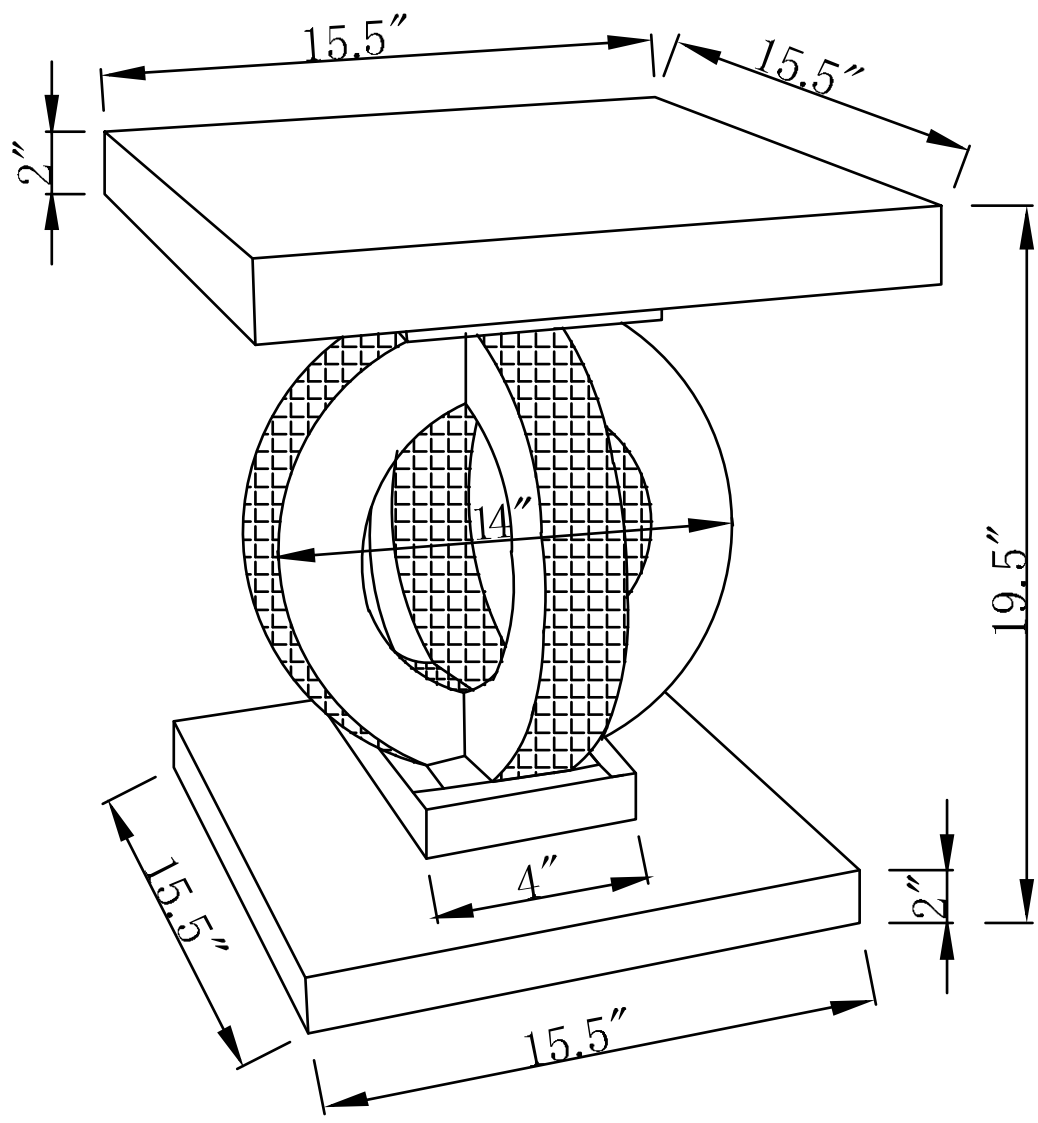

Note : Dimension tolerance $\pm 5\%$